



# 23,3 m Trawler



## SHIP INFORMATION HANDBOOK

# TABLE OF CONTENTS

---

RECORD OF CHANGE .....	5
FOREWORD .....	6 to 7
LIST OF ACRONYMS / ABBREVIATION UESD.....	8 to 9
LIST OF FIGURES.....	10 to 13
LIST OF MANUFACTURER'S DOCUMENTATION .....	14 to 16
PAINT SCHEDULE .....	17 to 19
SAFETY INFORMATION.....	20 to 22
CHAPTER 1 – SHIP CHARACTERISTICS .....	23 to 37
1-1. INTRODUCTION.....	23
1-2. SHIP CHACRACTERISTICS .....	23 to 24
1-3. RULES AND STANDARDS.....	25
FIGURES 1-1 to 1-12 .....	26 to 37
CHAPTER 2 – GENERAL ARRANGEMENT .....	38 to 64
2-1. GENERAL.....	38
2-2. STEERING GEAR ROOM .....	38
2-3. STORAGE ROOM .....	39
2-4. ENGINE ROOM .....	39
2-5. FISH HOLD.....	39
2-6. SANITARY ROOM .....	40
2-7. GALLEY / MESS.....	40
2-8. CREW'S QUARTERS .....	40
2-9. WORKSHOP .....	40
2-10. CO2 LOCKER .....	40
2-11. FORE PEAK .....	41
2-12. WHEELHOUSE .....	41
2-13. CAPTAIN CABIN.....	42
2-14. FISHING DECK.....	42
2-15. FORE DECK.....	42
2-16. BRIDGE DECK .....	42
2-17. UPPER DECK.....	43
2-18. WHEELHOUSE HOOD .....	43

Doc. Title	Ship Information Handbook		2 / 226
Doc. Reference	23,3 m Trawler		
Doc. Revision & Date	A - 15/09/14		

<b>2-19. MAST .....</b>	<b>43</b>
<b>FIGURES 2-1 to 2-58 .....</b>	<b>44 to 64</b>
<b>CHAPTER 3 – SHIP EQUIPMENT LIST .....</b>	<b>65 to 79</b>
<b>3-1. GENERAL INFORMATION.....</b>	<b>65 to 66</b>
<b>3-2. SHIP EQUIPMENT LIST DETAIL .....</b>	<b>67 to 79</b>
<b>CHAPTER 4 – SYSTEMS FUNCTIONAL DESCRIPTION.....</b>	<b>80 to 95</b>
<b>4-1. HULL CORROSION PROTECTION SYSTEM .....</b>	<b>80</b>
<b>4-2. ANCHORING AND MOORING SYSTEM.....</b>	<b>80</b>
<b>4-3. STEERING SYSTEM.....</b>	<b>80</b>
<b>4-4. HEATING, VENTILATION AND AIR CONDITIONING.....</b>	<b>81</b>
<b>4-5. SEA WATER COOLING SYSTEM FOR HVAC &amp; FISHING REFRIGERATION PLANT.....</b>	<b>81</b>
<b>4-6. FRESH WATER SYSTEM .....</b>	<b>81</b>
<b>4-7. FIREMAIN SYSTEM .....</b>	<b>82</b>
<b>4-8. BILGE SYSTEM .....</b>	<b>82</b>
<b>4-9. SEWAGE AND SANITARY SYSTEM .....</b>	<b>83</b>
<b>4-10. FUEL TRANSFER OIL SYSTEM.....</b>	<b>83 to 84</b>
<b>4-11. LUBRICATING OIL TRANSFER SYSTEM .....</b>	<b>84</b>
<b>4-12. REFRIGERATION PLANT FOR FISH AND ICE GENERATOR .....</b>	<b>84 to 85</b>
<b>4-13. CO2 FIRE EXTINGUISHING SYSTEM.....</b>	<b>85</b>
<b>4-14. AC 400V-3-50 Hz NETWORK.....</b>	<b>85 to 86</b>
<b>4-15. AC 400V-3-50 Hz SHAFT GENERATOR.....</b>	<b>86 to 87</b>
<b>4-16. AC 400-3-50 Hz GENERATOR SET.....</b>	<b>87</b>
<b>4-17. AC 230V-1-50 Hz LIGHTING NETWORK .....</b>	<b>87 to 88</b>
<b>4-18. DC24V NETWORK.....</b>	<b>88</b>
<b>4-19. PROPULSION SYSTEM.....</b>	<b>89</b>
<b>4-20. MAIN PROPULSION ENGINE .....</b>	<b>89</b>
<b>4-21 PROPELLER AND MARINE TRANSMISSION .....</b>	<b>89 to 90</b>
<b>4-22. EXHAUST SYSTEM.....</b>	<b>90</b>
<b>4-23. SEA WATER COOLING SYSTEM.....</b>	<b>91</b>
<b>4-24. MONITORING AND REMOTE CONTROL SYSTEM.....</b>	<b>91</b>
<b>4-25. INTERNAL COMMUNICATION SYSTEM .....</b>	<b>91 to 92</b>
<b>4-26. EXTERNAL COMMUNICATION SYSTEM.....</b>	<b>92</b>
<b>4-27. NAVIGATION SYSTEM.....</b>	<b>92 to 94</b>
<b>4-28. FISHING GEAR .....</b>	<b>94 to 95</b>

Doc. Title	Ship Information Handbook		3 / 226
Doc. Reference	23,3 m Trawler		
Doc. Revision & Date	A - 15/09/14		

4-29. FISH TREATMENT .....	95
<b>CHAPTER 5 – OPERATING INSTRUCTIONS .....</b>	<b>96 to 141</b>
5-1. GENERAL INFORMATION .....	96
5-2. PRE OPERATIONAL CHECKLIST .....	96 to 101
5-3. OPERATING OF THE SYSTEMS .....	101 to 141
<b>CHAPTER 6 – MAINTENANCE SCHEDULE .....</b>	<b>142 to 189</b>
6-1. GENERAL INFORMATION .....	142
6-2. ASSUMPTIONS USED TO ELABORATE THE MAINTANCE SCHEDULE .....	142
6-3. FUNCTIONING PRINCIPLE OF MAINTENANCE SCHEDULE TABLE .....	143
6-4. ANCILLARIES OF HULL .....	144 to 145
6-5. ELECTRICAL .....	146 to 148
6-6. MECHANICAL .....	149 to 160
6-7. COMMUNICATION & NAVIGATION .....	161 to 164
6-8. LUBRICANT SCHEDULE .....	165 to 166
6-9. COMMERCIAL LUBRICANTS DATA SHEETS .....	167 to 189
<b>CHAPTER 7 – FIGURES 7-1 to 7-36 .....</b>	<b>190 to 226</b>

Doc. Title	Ship Information Handbook		4 / 226
Doc. Reference	23,3 m Trawler		
Doc. Revision & Date	A - 15/09/14		

## RECORD OF CHANGE

---

Rev	Detailed subject of modification	Date	Author
A	First issue	01/10/2014	B. Renouf

Doc. Title	Ship Information Handbook		5 / 226
Doc. Reference	23,3 m Trawler		
Doc. Revision & Date	A - 15/09/14		

# FOREWORD

---

## PURPOSE

This document presents the Ship Information Handbook for the 23.3 m New Generation Trawler. It identifies the ship equipment, the operational instructions and the main maintenance operations. This manual describes a 23.3 m Trawler designed by Constructions Mécaniques de Normandie (CMN).

## MANUAL ORGANIZATION

This maintenance book is structured in seven sections as follows:

SECTION 1 : GENERAL

SECTION 2 : GENERAL ARRANGEMENTS

SECTION 3 : SHIP EQUIPMENT LIST

SECTION 4 : SYSTEMS FUNCTIONAL DESCRIPTION

SECTION 5 : OPERATING INSTRUCTIONS

SECTION 6 : MAINTENANCE SCHEDULE

SECTION 7 : SCHEMATIC SYSTEMS DIAGRAMS

## HOW TO USE THIS MANUAL

The Ship Information Handbook should be used in day-to-day operations and crew familiarization of the Trawler to locate and identify both general areas of the ship and specific equipment and systems.

- Use Section 1 for an overview of the ship.
- Use Section 2 to identify leading characteristics.
- Use Section 3 to identify equipment and systems throughout the ship and to find manufacturer's information and model types of system components.
- Use Section 4 for functional descriptions of specific equipment and systems.
- Use Section 5 for pre-operational checks and required procedures to operate and secure major equipment on the ship.
- Use Section 6 to find maintenance schedule of equipment on the ship.
- Use Section 7 schematic system diagrams to identify fluids and lubricants recommendations (i.e. hydraulic fluid, seawater, and potable water).

Doc. Title	Ship Information Handbook		6 / 226
Doc. Reference	23,3 m Trawler		
Doc. Revision & Date	A - 15/09/14		

**LIMITATIONS OF LIABILITY**

The present Ship Information Book applies to CMN 23,3m Trawler.

The information supplied in the Ship Information Book is valid at the time of issuing.

Although great care has been taken to provide the best possible information, errors or omissions cannot be excluded.

If you have any doubt or suggestion, please contact CMN.

Doc. Title	Ship Information Handbook		7 / 226
Doc. Reference	23,3 m Trawler		
Doc. Revision & Date	A - 15/09/14		

## LIST OF ACRONYMS/ABBREVIATION USED

AC	Alternating Current
A/C	Air Conditioning
ADF	Automatic Direction Finder
Ah	Ampere/Hour
AIS	Automatic Identification System
BNWAS	Bridge Navigational Watch Alarm System
CD	Compact Disc
CPM	Control Panel Module
CPP	Controllable Pitch Propeller
DGPS	Differential Global Position System
DC	Direct Current
DN	Diameter Nominal
DVD	Digital Video Disk
ECDIS	Electronic Charting Digital Information System
EOS	Electro-Optical System
EPIRB	Emergency Position Indicator Radio Beacon
FM	Frequency Modulated
FPP	Fixed Pitch Propeller
Fwd	Forward
GMDSS	Global Maritime Distress and Safety System
GP	Generator Panel
GPS	Ground Positioning System
HF/SSB	High Frequency / Single Side Band
HP	Horsepower
HPU	Hydraulic Power Unit
HVAC	Heating, Ventilating and Air Conditioning
Hz	Hertz
IMM	International Maritime Mobile
kG	Kilogram
kVA	Kilovolt Ampere
kW	Kilowatt
LCD	Liquid Crystal Display
LED	Light-Emitting Diode
m	Meter

Doc. Title	Ship Information Handbook		8 / 226
Doc. Reference	23,3 m Trawler		
Doc. Revision & Date	A - 15/09/14		



ME	Main Engine
MECS	Modular Electronic Control System
MEP	24 VDC Main Engine Panel
MF BLU	Moyenne Fréquence / Bande Laterale Unique
mm	Millimeter
NA	Not Applicable
NC	Not Codified
NiCad	Nickel Cadmium
NMEA	National Marine Electronics association
NUC	Not Under Command
OEM	Original Equipment Manufacturer
PH	Pilothouse
PMM	Maintenance Manual
Port	Portside
psi	Pounds per square inch
PTO	Power Take Off
RAM	Restricted Ability to Maneuver
RHIB	Rigid Hull Inflatable Boat
RPM	Revolutions per Minute
SART	Search And Rescue Radar Transponder
SEL	Ship Equipment List
SOLAS	Safety Of Life At Sea
Stbd	Starboard Side
SW	Sea Water
TBD	To be determined
V	Volt
VAC	Volts Alternating Current
VCR	Video Cassette Recorder
VDC	Volts Direct Current
VHF	Very High Frequency
VMS	Virtual Memory system
W	Watt

Doc. Title	Ship Information Handbook		9 / 226
Doc. Reference	23,3 m Trawler		
Doc. Revision & Date	A - 15/09/14		

## LIST OF FIGURES

Figure Number	Figure Title	Page
Figure 1-1	General Arrangement.....	26
Figure 1-2	Draught Marks.....	27
Figure 1-3	Docking Plan .....	28
Figure 1-4	Shell Penetrations.....	29
Figure 1-5	Life Saving.....	30
Figure 1-6	Outboard & Inboard Profiles .....	31
Figure 1-7	Outboard & Inboard Decks.....	32
Figure 1-8	Upper Decks Arrangement .....	33
Figure 1-9	Watertight Doors and Hatches Arrangement .....	34
Figure 1-10	Engine Room Arrangement .....	35
Figure 1-11	Wheelhouse Arrangement .....	36
Figure 1-12	Mast Arrangement .....	37
Figure 2-1	Aft view of ship.....	44
Figure 2-2	Mast and aerals .....	44
Figure 2-3	Wheelhouse External View .....	44
Figure 2-4	Bridge Deck.....	45
Figure 2-5	Aft Deck – Gantry with Dual & Single Net Drums.....	45
Figure 2-6	Upper Deck – Gilson Winch.....	45
Figure 2-7	Fishing Deck – Portside Warp.....	46
Figure 2-8	Portside Upper Deck – Single Net Drum .....	46
Figure 2-9	Gantry – Leading Block.....	47
Figure 2-10	Gantry – 15 Tons Warp Block.....	47
Figure 2-11	Gantry – 6 Tons Warp Block.....	47
Figure 2-12	Stbd Upper Deck – Liferaft & Warp Cable Block .....	47
Figure 2-13	Fishing Deck – Fishing Deck Control Panel .....	48
Figure 2-14	Fishing Deck – Fishing Gear Electrical Control Box.....	48
Figure 2-15	Fishing Deck – Fish Conveyor with Unloading Tank .....	48
Figure 2-16	Fishing Deck – Fish Conveyor .....	49
Figure 2-17	Port Upper Deck – Shore Connections .....	49
Figure 2-18	Bridge Deck – Technical Fresh Water Filling Connection .....	49
Figure 2-19	Stbd Upper Deck – Domestic Fresh Water Filling Connection .....	50
Figure 2-20	Wheelhouse – Fwd Console .....	50
Figure 2-21	Wheelhouse – Corner & Stbd Console.....	51
Figure 2-22	Wheelhouse – Aft Console .....	51
Figure 2-23	Captain Cabin .....	51
Figure 2-24	Fore peak.....	52
Figure 2-25	Fore peak – Ice Generator.....	52
Figure 2-26	Galley – Cooker & Sink .....	52

Doc. Title	Ship Information Handbook		10 / 226
Doc. Reference	23,3 m Trawler		
Doc. Revision & Date	A - 15/09/14		

Figure 2-27	Galley – Sink & Refrigerator .....	53
Figure 2-28	Mess .....	53
Figure 2-29	CO2 Locker.....	53
Figure 2-30	Workshop – Storage Room Hatch .....	53
Figure 2-31	Workshop – Aft Stern Tube Lub Oil Tank .....	54
Figure 2-32	Crew Quarters – Entrance of Oil Clothes Room .....	54
Figure 2-33	Crew Quarters – 7 Men Cabin .....	54
Figure 2-34	Crew Quarters - Sanitary .....	54
Figure 2-35	Crew Quarters – Gravity Toilet.....	55
Figure 2-36	Fishing Deck – Aft Port Freeing Port.....	55
Figure 2-37	Fore Fishing Deck – Fish Hold Hatch .....	55
Figure 2-38	Fore Fishing Deck – Electric Winch for Hoisting Mast.....	56
Figure 2-39	Steering Room – Rubber Stock & Steering Cylinders .....	56
Figure 2-40	Steering Room – Hydraulic Power Units .....	56
Figure 2-41	Steering Room – Oil Tank, Double with Emerg.Manual Pump.....	57
Figure 2-42	Storage Room – Refrigeration Plant for Fish Hold & Ice Generator...	57
Figure 2-43	Storage Room – Hydraulic Distribution Block for fishing gear.....	58
Figure 2-44	Storage Room – Fore Shaft Seal Lub Oil Tank. ....	58
Figure 2-45	Storage Room – Fore Stern Tube Seal & Propeller Shaft. ....	58
Figure 2-46	Engine Room – Main Engine.....	59
Figure 2-47	Engine Room – Reduction Gearbox.....	59
Figure 2-48	Engine Room – 100 kVA Shaft Generator.....	60
Figure 2-49	Engine Room – HP Hydraulic Pump for Fishing Gear. ....	60
Figure 2-50	Engine Room –Generator Set.....	61
Figure 2-51	Engine Room –Fuel Oil Transfer Manifold.....	61
Figure 2-52	Engine Room – Oil Tank for Hydraulic Fishing Gear.....	62
Figure 2-53	Engine Room – Fuel Oil Separator & Transfer Pump. ....	62
Figure 2-54	Engine Room – Fire Pump. ....	63
Figure 2-55	Engine Room – SW Cooling Pumps for Fish Hold Refrigeration Unit .	63
Figure 2-56	Engine Room – Sea & Fresh Water Pressure Pumps.....	64
Figure 2-57	Fish Hold Starboard Side. ....	64
Figure 2-58	Fish Hold PortSide. ....	64
Figure 5-1	Steering Gear – Electrical Starters HPU1 & 2 .....	102
Figure 5-2	Bridge – Steering Gear Remote Control Monitoring Alarm Panel ..	102
Figure 5-3	Bridge – Steering Wheel.....	102
Figure 5-4	Bridge – Auto Manual Steering Selector .....	102
Figure 5-5	Stbd Engine Room – SW AC Cooling Pumps.....	104
Figure 5-6	Engine Room – FW Pressure Pump .....	105
Figure 5-7	Fishing Deck – Aseptic Filter.....	105
Figure 5-8	Engine Room – Fire Pump .....	106
Figure 5-9	Engine Room – Sea Water Pressure Pump.....	106

Doc. Title	Ship Information Handbook		11 / 226
Doc. Reference	23,3 m Trawler		
Doc. Revision & Date	A - 15/09/14		

Figure 5-10	Main switchboard – Fire Pump Control .....	107
Figure 5-11	Workshop – Fire Pump Remote Control Panel .....	107
Figure 5-12	Engine Room – Bilge Pumps .....	109
Figure 5-13	Engine Room – Bilge Manifold .....	109
Figure 5-14	Main switchboard – Bilge Pumps Control .....	109
Figure 5-15	Engine Room – Bilge Pumps Remote Control Panels .....	109
Figure 5-16	Port Engine Room – FO Transfer Pump & Centrifugal Separator.....	112
Figure 5-17	Main switchboard – FO Transfer Pump Control Panel.....	112
Figure 5-18	Engine Room – FO Transfer Pump Remote Control Panel .....	112
Figure 5-19	CO2 Room –FO Quick Closing Valves .....	112
Figure 5-20	Engine Room – FO Service Tank .....	112
Figure 5-21	Stbd Engine Room – Lubricating Oil Transfer Hand Pump .....	114
Figure 5-22	Engine Room – New Oil & Polluted Oil Tanks .....	114
Figure 5-23	CO2 Cylinders 1 and 2.....	115
Figure 5-24	Mechanical Release Lever (cyl.1) and pneumatic release (cyl.2).....	115
Figure 5-25	CO2 Isolating Valve.....	115
Figure 5-26	Main Electrical switchboard – Production Cell.....	117
Figure 5-27	Main Electrical Switchboard – Production Cell .....	121
Figure 5-28	Genset – Battery Master Key .....	121
Figure 5-29	Genset – Control Panel.....	121
Figure 5-30	Genset – Bridge Remote Control Panel.....	121
Figure 5-31	Bridge – Bilge Alarm Panel .....	124
Figure 5-32	Bridge – General Alarm Panel .....	125
Figure 5-33	Bridge – Navigational Watch Alarm .....	126
Figure 5-34	Bridge – Navigation Lights Monitoring & Control Panel .....	126
Figure 5-35	Bridge – MECP 1 Engine Control Panel.....	127
Figure 5-36	Bridge – Engine Remote Control Panel .....	127
Figure 5-37	Bridge – Mechanical Control Head.....	127
Figure 5-38	Engine Room – ME Battery Master Key .....	127
Figure 5-39	Bridge – Pitch Propeller Remote Control Panel .....	134
Figure 5-40	Bridge – Gearbox Clutching Remote Control Panel .....	134
Figure 5-41	Engine Room – Manual Clutching of Propeller Shaft .....	135
Figure 5-42	Engine Room –Propeller Shaft Cylinder .....	136
Figure 5-43	Engine Room – Mechanical Locking of Propeller Pitch .....	136
Figure 5-44	Engine Room – Fishing Gear SW Cooling E-Pump .....	137
Figure 5-45	Engine Room – SW Strainer.....	137
Figure 5-46	Engine Room – Hydraulic Pump for Fishing Gear.....	139
Figure 5-47	Fishing Deck –Fishing Gear Electrical Panel.....	140
Figure 5-48	Fishing Deck –Fishing Gear Deck Control Panel .....	140
Figure 5-49	Store Room –Fishing Gear Hydraulic Distributor .....	141
Figure 7-1	Hull Corrosion Protection System .....	191
Figure 7-2	Rudder Stock .....	192



Doc. Title	Ship Information Handbook		12 / 226
Doc. Reference	23,3 m Trawler		
Doc. Revision & Date	A - 15/09/14		

Figure 7-3	Steering Gear System .....	193
Figure 7-4	Steering Gear Network.....	194
Figure 7-5	AC Sea Water Cooling System .....	195
Figure 7-6	HVAC System .....	196
Figure 7-7	HVAC Electrical Network .....	197
Figure 7-8	Fresh Water System .....	198
Figure 7-9	Firemain System .....	199
Figure 7-10	Bilge System .....	200
Figure 7-11	Sewage System.....	201
Figure 7-12	Marine Fuel Oil System.....	202
Figure 7-13	Lubricating Oil System .....	203
Figure 7-14	Air Vent, Sounding and Overflow System .....	204
Figure 7-15	Fish Hold Refrigeration System .....	205
Figure 7-16	Ice Generator Refrigeration System.....	206
Figure 7-17	Fish Hold Refrigeration Plant Electrical Network .....	207
Figure 7-18	Fire Detection System .....	208
Figure 7-19	CO2 Fire Extinguishing System .....	209
Figure 7-20	Electric Equipment Location.....	210
Figure 7-21	AC 400V 50Hz Network .....	211
Figure 7-22	Main Switchboard Diagram.....	212
Figure 7-23	AC 230V Secondary Switchboards Diagram .....	213
Figure 7-24	DC 24V Distribution Network & Wheelhouse Frame Diagram.....	214
Figure 7-25	DC 24V Navigation Light Network .....	215
Figure 7-26	DC 24V Network .....	216
Figure 7-27	Exhaust System.....	217
Figure 7-28	Controllable Pitch Propeller & Transmission Plant .....	218
Figure 7-29	Engine Cooling System .....	219
Figure 7-30	Alarm & Safety Network.....	220
Figure 7-31	Propulsion & Generators Monitoring & Control Network .....	221
Figure 7-32	Wheelhouse Fwd Console .....	222
Figure 7-33	Wheelhouse Stbd, Corner & Aft Consoles.....	223
Figure 7-34	Internal Communications System .....	224
Figure 7-35	External Communications System.....	225
Figure 7-36	Fishing Gear System .....	226

Doc. Title	Ship Information Handbook		13 / 226
Doc. Reference	23,3 m Trawler		
Doc. Revision & Date	A - 15/09/14		

## LIST OF MANUFACTURER'S DOCUMENTATION

N°	EQUIPMENT DESCRIPTION	ORIGINAL SUPPLIER	DOCUMENTATION TYPE	DOCUMENTATION REFERENCE	C D
1	Centrifugal Water Separator Unit 760l/h	Alfa Laval	Separator Manual MIB 303S-13/33	9001834-02 Rev.2	1
			Spare Parts Catalogue MIB 303S-13/33	9001946-02 Rev.1	
			System manual MIB 303 Separation System, AC Module	9001928-02	
2	Main Propulsion Diesel Engine	Enéria	Operation & Maintenance Manual C32 Marine Engine (Caterpillar)	SEBU8773-02 October 2013	1
3			Parts Manual C32 Marine Engine (Caterpillar)	SEBP6147 November 2012	
4	Generator Set AC400V-50Hz	Enéria	Operation & Maintenance Manual C4.4 (Mech) Marine Generator Set MCS-3 (Caterpillar)	SEBU8607-01 March 2013	1
5			Parts Manual C4.4 - Marine Gen Set (Caterpillar)	SEBP4152 June 2009	
6	Generator Set AC400V-50Hz	Enéria	Alternator LSA 43.2/44.2-4 poles - Installation & Maintenance	3434 en-2011.06/j	1
			Alternator LS R438 A.V.R.- Installation & Maintenance	3971 en-2010.11/f	
			Alternator LS Generals recommendations for storing & installing alternators	2261 - 2008.10/d	
			Deap Sea Electronics Pic - Model 520 - Remote Start Engine Management System - Ooperators Manual	DES 520 / ISSUE 4 KT	
	Engine Control Station (Analog Control Head)	Enéria	Twin Disc - Marine Control System Model EC300 System Operation & Maintenance Manual	1024421	
	Reverse & Reduction Gear Box	Enéria	Twin Disc - Marine Transmission MG & MGX-5222DC/5225DC- Service Manual	1023375 1/3	
	Fuel Oil/Water Static Duplex Separator - for Main Engine	Enéria	7590MAX & 75100MAX Marine Fuel Filter/Water Separators	Instruction part Number 19536 Rev A June 2010	
	Fuel Oil Sedimenter / Water - for Genset	Enéria	7240 (kit) Parts List	02/02/7273	
	Fire Detection Panel	Marinelec	DI09 - Installation & User Manual	DI09_MANUAL_GB REV2	
			DI09 - Product Specifications	DI09 FP GB REV 0.doc	
			Accessories Conventionale Fire Detection - PG01 Product Data Sheet	FP DETECTEURS CONV GB REV 1	
	Navigation Lights Monitoring & Control Panel	Marinelec	NORMA - Product Specifications PG 3	NORMA FP GB REV 1.doc	
			NORMA CP - Installation & User Manual	NORMA_CP_MANU GB rev1	
			NORMA CPU - Installation & User Manual	NORMA_CPU_MANU GB rev3	
	Automatic Sound Signals Sequencer	Marinelec	CAPELLA V2 - Monitoring of sound signals	MANUAL CAPELLA V2 INDICE B.doc	
CAPELLA V2 - Automatic Sound Signals Sequencer			CAPELLA_V2 FP GB A		
Bilge Alarm Panel	Marinelec	ALTAIR V2 - Faultt Detection	NFALTAIRV2GB B		
		ALTAIR 8 V2 - Faultt Detection Panel	ALTAIR V2 FP GB C		
Bilge Alarm Acquisition Box	Marinelec	ALTOR4/ALTOR8 - Installation & User Manual	ALTOR8 ALTOR4 MANUEL_GB_rev_0 17/04/2014		
		ALTOR8 - PG 07 Product Specifications	FP ALTOR8 GB REV H.doc		

Doc. Title	Ship Information Handbook		14 / 226
Doc. Reference	23,3 m Trawler		
Doc. Revision & Date	A - 15/09/14		

N°	EQUIPMENT DESCRIPTION	ORIGINAL SUPPLIER	DOCUMENTATION TYPE	DOCUMENTATION REFERENCE	C D
6	Bridge Navigational Watch Alarm Box	Marinelec	LYNX V3S - Installation & User Manual	LYNX_V3S_MANU_GB_rev0.doc	1
			LYNX V3S - Product Specifications	FP LYNX V3S FR REV D.doc	
	Battery Master Switch	Reya	Tehcnical Data Sheet Double pole main switch with auxiliary circuit and manual control	20110907	
	CO2 Extinguishing system	Tyco	Technical document	REF TM659048	
	Heating - Ventilation & Air Conditioning System	Webasto	Marine Self-Contained Air-Conditioning Systems - Installation instructions Blue Cool S Series	WBLC010535A - 11/12	
	Sea Water E-Pump 1,3m3/h	Webasto	Technical Data Sheet	01ACP202 GW_ST 22/07/13	
			GIANNESCHI Pumps & Blowers "CP20G"	CP20G 04/2010	
GIANNESCHI Pumps & Blowers First Start Instruction			-		
Relay Box - SW E-Pump	Webasto	Installation instruction relay boxes BlueCool, several units, one sea water pump	WBCL010572A 7/13		
7	Steering Gear	Fluidmeccanica	Manual Instructions & General Maintenance	LBI003053	1
8	Internal & External Communication System	Marelec	Operator & Installation Manual	From AIS to RAD	1
9				From RD33 to VMS	
10	Refrigeration Plant for Fish Hold & Ice Maker	France Agro Industrie	Operating Instructions	DB-200-4	1
11	Gel batteries	Seimi	Technical Support	Version 0 date : December 12 <sup>th</sup> 2013	1
	Lighting				
	Searchlights				
	Navigation Lights				
	Ship's Whistle				
	Windscreen Wipers				
	AGM Batteries				
Steering Gear	Seimi	User & Maintenance Manual Tellarini Pump	Ed 03 Rev 1 15/01/2014		

Doc. Title	Ship Information Handbook		15 / 226
Doc. Reference	23,3 m Trawler		
Doc. Revision & Date	A - 15/09/14		

N°	EQUIPMENT DESCRIPTION	ORIGINAL SUPPLIER	DOCUMENTATION TYPE	DOCUMENTATION REFERENCE	C D
12	Inflatable Liferaft Flat 8 Men Pack B	Arimar	Deep Sea SOLAS Liferrafts-Installation, use & Maintenance Manual	MC 610895 - 10/10/2005	1
	Hydrostatic Release Unit	Arimar	Hammar H20 Manual - Mounting Instructions	Art.no.HT-0019/03	
	Fishing Equipment	Benne	General User Instructions	-	
	Fishing Equipment	Bopp	Trawler Deck Equipment	A13036	
	Fan Unit, Helicoïd - Air Exhaust	Enag	Tropicalized Exhaust Fan - Maintenance Guide	20097DAA	
	Converter, Static - AC230V/DC24V 60A	Enag	Utilisation Manual	CDS3-3M-DED	
	GMDSS Power Supply Box	Enag	Utilisation Manual	06715DAC	
	Electric Winch AC220V 500kg	Magi	TRBoxter 250 to 500 kg - Instruction Manual	188-178.12/1	
	Fan Unit, Centrifugal 100/400m3/h	Ouest Isol	Assembly Instruction - Tube Fan (metal)	mrm_pb_08_k10031 print 23.01.2013	
	Sea Water Centrifugal Selfpriming E-Pump 10m3/h 20m	Semim	Operation & Instruction Manual - Centrifugal Selfpriming Pumps	CA 05/12	
	Fresh Water Pressure Centrifugal E-Pump Unit 2,5m3/h 31,5m + 20 litre Receiver	Semim	Instruction Manual - Centrifugal Pumps Series CP	CPANLN 05/11	
	Sea Water Centrifugal Selfpriming Main Firefighting E-Pump 25m3/h 30m	Semim	Instruction Manual - Side Channel mustistage selpriming Pumps Series SP	sp 1/12	
13	AC 400V - 50Hz Electrical Network	SA2I	Technical Documentation	-	1
14	Reduction Gear Box & Elastic Coupling (shaft generator)	Masson	Operating Instructions Marine Gears type W3900/4400/5200	M-5200/v.07/12-2013	1
	Shafting Line & Controllable Pitch Propeller (CPP)		Operating Instructions	CCP MMS 480 – MMCPP0042	
	Shafting Line & Controllable Pitch Propeller (CPP)		Twin Disc-Marine Control System Model EC300 System Operation & Maintenance Manual	CCP MMS 480 – MMCPP0042	

Doc. Title	Ship Information Handbook		16 / 226
Doc. Reference	23,3 m Trawler		
Doc. Revision & Date	A - 15/09/14		



## PAINT SCHEDULE

---

### PRODUCTS

Manufacturer : International Paints

Product	Paint Type	Product Code	Colour	Thinner
Intergard 269	Epoxy Primer/Tie Coat	EGA088/EGA089	Red	GTA220
Intergard 7600	Pure Epoxy Primer Universal	KUA763/KUA764	Grey	GTA220
Interline 925	Epoxy Coating for Tank	THA125/THA127	White RAL 9016	NA
Interprime 539	Without Chromate Etch Primer	VTA538	Yellow	GTA220
Interseal 670 HS	Surface Tolerant Epoxy	EGD704/EGA247	Grey	GTA220
Intershield 300	Abrasion Resistant Aluminium Pure Epoxy	ENA301/ENA303	Aluminium	GTA220
Intershield 300	Abrasion Resistant Aluminium Pure Epoxy	ENA300/ENA303	Bronze	GTA220
Intersleek 737	Intermediate Elastomer Type	BXA736/BXA738/BXA739	Pink	GTA007
Intersleek 757	Anti-Adhesive Elastomer Paint	BXA755/BXA758/BXA759	Black	GTA007
Interthane 990	Polyurethane Finish	PHB000/PHA046	White RAL 9016	GTA056, GTA713, GTA733
Interthane 990	Polyurethane Finish	PHB953/PHA046	Blue RAL 5005	GTA056, GTA713, GTA733
Interthane 990	Polyurethane Finish	PHZ651/PHA046	Grey RAL 7040	GTA056, GTA713, GTA733
Interthane 990	Polyurethane Finish		Grey RAL 7035	GTA056, GTA713, GTA733

Doc. Title	Ship Information Handbook		17 / 226
Doc. Reference	23,3 m Trawler		
Doc. Revision & Date	A - 15/09/14		

**PAINT SYSTEMS**

Product	Paint Type	Product Code	Colour	Dry Thickness Microns
---------	------------	--------------	--------	-----------------------

**Underwater Areas and Sea Chests – Area : 248 m<sup>2</sup>**

Intershield 300	Abrasion Resistant Aluminium Pure Epoxy	ENA301/ENA303	Aluminium	125
Intershield 300	Abrasion Resistant Aluminium Pure Epoxy	ENA300/ENA303	Bronze	125
Intersleek 737	Intermediate Elastomer Type	BXA736/BXA738 /BXA739	Pink	100
Intersleek 757	Anti-Adhesive Elastomer Paint	BXA755/BXA758 /BXA759	Black	150

**Topsides Area & Stern Gantry - Area : 113 m<sup>2</sup>**

Intershield 300	Abrasion Resistant Aluminium Pure Epoxy	ENA301/ENA303	Aluminium	200
Interthane 990	Polyurethane Finish	PHB000/PHA046	White RAL 9016	50
Interthane 990	Polyurethane Finish	PHB000/PHA046	White RAL 9016	50

**Topsides Area (Blue Area) - Area : 35 m<sup>2</sup>**

Interthane 990	Polyurethane Finish	PHB953/PHA046	Blue RAL 5005	50
Interthane 990	Polyurethane Finish	PHB953/PHA046	Blue RAL 5005	50

**Open Decks - Area : 103 m<sup>2</sup>**

Intergard 7600	Pure Epoxy Primer Universal	KUA763/KUA764	Grey	200
Interthane 990	Polyurethane Finish	PHZ651/PHA046	Grey RAL 7040	50
Interthane 990	Polyurethane Finish	PHZ651/PHA046	Grey RAL 7040	50

**Deck Gear & Radome - Area : 92 m<sup>2</sup>**

Intergard 7600	Pure Epoxy Primer Universal	KUA763/KUA764	Grey	200
Interthane 990	Polyurethane Finish	PHB000/PHA046	White RAL 9016	50
Interthane 990	Polyurethane Finish	PHB000/PHA046	White RAL 9016	50

**Aluminium Superstructures & Mast - Area : 79 m<sup>2</sup>**

Intergard 269	Epoxy Primer/Tie Coat	EGA088/EGA089	Red	50
Intergard 7600	Pure Epoxy Primer Universal	KUA763/KUA764	Grey	100
Interthane 990	Polyurethane Finish	PHB000/PHA046	White RAL 9016	50
Interthane 990	Polyurethane Finish	PHB000/PHA046	White RAL 9016	50

**Aluminium Superstructures (Blue Area) – Area : 5 m<sup>2</sup>**

Interthane 990	Polyurethane Finish	PHB953/PHA046	Blue RAL 5005	50
Interthane 990	Polyurethane Finish	PHB953/PHA046	Blue RAL 5005	50

**Main working area, bulwark, walls and ceiling - Area : 209 m<sup>2</sup>**

Intergard 7600	Pure Epoxy Primer Universal	KUA763/KUA764	Grey	200
Interthane 990	Polyurethane Finish		Grey RAL 7035	50
Interthane 990	Polyurethane Finish		Grey RAL 7035	50

Doc. Title	Ship Information Handbook		18 / 226
Doc. Reference	23,3 m Trawler		
Doc. Revision & Date	A - 15/09/14		

Main working Deck - Area : 92 m<sup>2</sup>

Product	Paint Type	Product Code	Colour	Dry Thickness Microns
Intergard 7600	Pure Epoxy Primer Universal	KUA763/KUA764	Grey	200
Interthane 990	Polyurethane Finish	PHZ651/PHA046	Grey RAL 7040	50
Interthane 990	Polyurethane Finish	PHZ651/PHA046	Grey RAL 7040	50

Nobel Clad Weld - Area : 9 m<sup>2</sup>

Intergard 7600	Pure Epoxy Primer Universal	KUA763/KUA764	Grey	100
----------------	-----------------------------	---------------	------	-----

Steering Gear Area - Area : 170 m<sup>2</sup>

Interseal 670 HS	Surface Tolerant Epoxy	EGD704/EGA247	Grey	150
------------------	------------------------	---------------	------	-----

Engine Room - Area : 394 m<sup>2</sup>

Interseal 670 HS	Surface Tolerant Epoxy	EGD704/EGA247	Grey	150
------------------	------------------------	---------------	------	-----

Fish Hold under insulation & under Floor - Area : 300 m<sup>2</sup>

Interseal 670 HS	Surface Tolerant Epoxy	EGD704/EGA247	Grey	125
------------------	------------------------	---------------	------	-----

Accomodations, Wals, Floors & Ceilings - Area : 269 m<sup>2</sup>

Interseal 670 HS	Surface Tolerant Epoxy	EGD704/EGA247	Grey	125
------------------	------------------------	---------------	------	-----

Ventilation Galvanized Ducts - Area : 31 m<sup>2</sup>

Interprime 539	Without Chromate Etch Primer	VTA538	Yellow	15
Interseal 670 HS	Surface Tolerant Epoxy	EGD704/EGA247	Grey	125

Stell Pedestal and Pipes - Area : 185 m<sup>2</sup>

Interseal 670 HS	Surface Tolerant Epoxy	EGD704/EGA247	Grey	125
------------------	------------------------	---------------	------	-----

Aluminium Pedestal and Pipes - Area : 60 m<sup>2</sup>

Intergard 269	Epoxy Primer/Tie Coat	EGA088/EGA089	Red	
---------------	-----------------------	---------------	-----	--

Tweendeck Fore Peak - Area : 117 m<sup>2</sup>

Interseal 670 HS	Surface Tolerant Epoxy	EGD704/EGA247	Grey	125
------------------	------------------------	---------------	------	-----

Fresh Water Tank - Area : 14 m<sup>2</sup>

Interline 925	Epoxy Coating for Tank	THA125/THA127	White RAL 9016	300
---------------	------------------------	---------------	----------------	-----

Doc. Title	Ship Information Handbook		19 / 226
Doc. Reference	23,3 m Trawler		
Doc. Revision & Date	A - 15/09/14		

# SAFETY INFORMATION

---

## GENERAL SAFETY NOTICES

The following general safety notices supplement specific warnings and cautions appearing in manufacturers and suppliers manuals.

General precautions must be understood and applied during operation and maintenance.

The following general safety notices supplement specific warnings and cautions appearing elsewhere in this manual. General precautions must be understood and applied during operation and maintenance. The Captain or other authority will issue orders as deemed necessary for any situation not covered in the general and specific safety precautions.

## FIRST AID

An injury, no matter how slight, should never go unattended. Always obtain first aid or medical attention immediately.

## EQUIPMENT LOCKOUT/TAGOUT

Operating personnel shall turn off and disconnect the machinery or equipment from its energy source before performing service or maintenance and the authorized personnel either lock or tag the energy-isolating device to prevent the release of hazardous energy and take steps to verify that the energy has been isolated effectively.

## DO NOT REPAIR OR ADJUST ALONE

Under no circumstance should any person reach into or enter equipment enclosures for the purpose of servicing or adjusting equipment except in the presence of personnel capable of rendering aid.

## HIGH VOLTAGE PREVENTION

Never work alone with high voltage. Have a partner who knows how to disconnect the power and who knows Cardio Pulmonary Resuscitation. A healthy person can be easily restarted after electrocution. High voltages may not kill, but can cause dangerous currents to flow.

Rule of thumb: 1 mA (milli-Ampere, or 0.001 Amps) is startling, 10 mA is painful, 100 mA can cause the heart to go into fibrillation or stop. An old electrician's trick to avoid accidental passage of electricity through the heart is to work with one hand and keep the other hand in a pocket.

Doc. Title	Ship Information Handbook		20 / 226
Doc. Reference	23,3 m Trawler		
Doc. Revision & Date	A - 15/09/14		

## **IN CASE OF ELECTROCUTION REMOVE THE POWER! Don't become an additional victim**

Turn off or disconnect power source. If unable to reach a switch or plug, use an insulated tool such as a wooden broom handle or rolled up paper to separate the victim from the power source. If extremely high voltages are present, use only the best insulators, like a clean, dry PVC pipe. Check if the victim is conscious. If victim is unconscious check for breathing and pulse, administer Standard CPR if needed. Once consciousness is restored, check for burns. Administer Standard First Aid for burns.

## **KEEP AWAY FROM LIVE CIRCUITS**

Operating personnel must observe all safety regulations at all times. Do not replace components, make adjustments or perform internal equipment maintenance without first securing electrical power. Potentially dangerous current may still exist when the electrical power is in the "OFF" position because of charges retained by capacitors.

Before touching, always secure electrical power and discharge the circuit by shorting through a load to ground with a shorting probe.

## **ENERGIZED EQUIPMENT**

Before working on energized equipment obtain Captain approval. Ensure personnel protective measures are taken to prevent grounding.

Energized equipment can be considered any component that has electrical, hydraulic or fluid power energy contained within, as well as, a high potential to transfer that energy from the component to another object.

Replacement or repair of components should be done only after the affected circuit has been secured, locked out and tagged out.

Replacement or repair of components with the circuit still energized may result in serious injury or death.

Take great care when working around energized electrical equipment.

Contact between unprotected body parts and electrical conductors can cause serious injury or death.

Do not wear jewelry or other conductive items while servicing energized electrical equipment.

Failure to comply with these precautions can cause serious injury or death.

Never work alone.

## **ROTATING AND RADIATING EQUIPMENT**

Secure all rotating and radiating equipment prior to personnel going aloft to perform related maintenance items.

A safety watch shall be posted if equipment must be repaired/adjusted while in motion.

The safety watch must have a full view of the repair/adjustment operation and immediate access to controls that can stop the equipment in motion.

## **FUEL HANDLING**

Fuel vapors are explosive.

Fuel is flammable.

Doc. Title	Ship Information Handbook		21 / 226
Doc. Reference	23,3 m Trawler		
Doc. Revision & Date	A - 15/09/14		

Before fueling the tanks or transferring fuel, ensure that firefighting equipment is immediately available for use in case of fire emergency.

Do not smoke or allow smoking, or any other open flame in the vicinity of the fueling operation.

Wipe clean any fuel spillage and dispose of spilled fuel in accordance with the appropriate regulations.

Failure to comply can result in death or serious injury.

## BATTERIES

Batteries are filled with a sulfuric acid based electrolyte.

This electrolyte is extremely corrosive to human tissues and many other materials.

If spilled electrolyte comes in contact with clothing or other material, wash the affected area with large volumes of fresh water.

If the electrolyte comes in contact with the skin, flush the area with large volumes of fresh water.

If the electrolyte comes in contact with the eyes, flush them with large volumes of fresh water.

Acids can be neutralized with SodiumBicarbonate,  $\text{NaHCO}_3$ , beware of possible violent chemical reaction.

Mixing strong acids and alkalis can cause violent chemical reactions.

Continue flushing the affected area until medical assistance arrives.

Failure to comply can result in death or serious injury.

Batteries produce hydrogen gas which is explosive.

Keep the work area free of sparks, open flame, and excessive heat.

## OILS AND CLEANING SOLVENT

Do not allow hydraulic fluid, engine oil or cleaning solvents to come in contact with unprotected skin or eyes.

Prolonged skin contact can cause illness or injury.

Eye contact can cause serious injury.

Always wear chemical protective gloves and goggles when handling hydraulic fluid, engine oil and cleaning solvents.

Failure to comply can result in death or serious injury.

Cleaning solvents are flammable and their vapor is potentially combustible or explosive.

Do not use cleaning solvents in the vicinity of sparks, open flame or excessive heat.

Do not use cleaning solvents in unventilated spaces.

Failure to comply can result in death or serious injury.

Doc. Title	Ship Information Handbook		22 / 226
Doc. Reference	23,3 m Trawler		
Doc. Revision & Date	A - 15/09/14		

# CHAPTER 1 – SHIP CHARACTERISTICS

---

## 1-1. INTRODUCTION

### 1-1-1. Ship type and brief description

The ship is mainly used as a deep sea Trawler and as a pelagic Trawler.

The rate of use is about 250 days per year.

Each campaign lasts approximately 10 days.

The boat is designed and life saving appliances provided for in accordance with the requirements of the French Flag Authorities for operations in 2nd category of navigation (up to 200 miles from safe haven and with maximum voyage distance of 600 miles).

The propulsive power is 559 kW.

The gross tonnage of the Trawler is about 195 UMS.

### 1-1-2. Hull shape

Hard-chine displacement hull.

The hull shape is designed to reduce the resistance and so the fuel consumption: a bulb improves the resistance (decreases the resistance) and pitch damping.

Two bilge keels are welded to the hull to reduce rolling amplitude.

Zinc anodes are located on the hull below the waterline to protect the underwater hull of electrolytic corrosion.

## 1-2. SHIP CHARACTERISTICS

The characteristics mentioned in this document can be slightly modified to allow possible improvements in the performances, the capacities or the construction of the ship.

### 1-2-1. Main Characteristics

Length overall	: 23.3 m
Length between perpendiculars	: 21.9 m
Breadth at deck level	: 8.0 m
Depth midships	: 4.0 m
Draught midships (approx.)	: 3.2 m
Maximum draught (stern draught)	: 3.5 m

Doc. Title	Ship Information Handbook		23 / 226
Doc. Reference	23,3 m Trawler		
Doc. Revision & Date	A - 15/09/14		

**1-2-2. Crew**

Captain : 1  
 Crew : 7  
 Total : 8 men

**1-2-3. Capacities**

Fuel oil : 34000 l  
 Fresh water : 3000 l  
 Technical fresh water : 12000 l  
 Provisions : 12 days  
 Fish hold : 650 boxes of 800 x 450 x 250 mm

**1-2-4. Speed**

The maximum free running speed of the ship is approximately 9.5 knots and is achieved in the following conditions:

- With medium load :
  - Full crew
  - 50% of fuel oil and new lube oil
  - 100% of water (ice + fresh water)
  - 50 % of fish in fish hold (12 t)
- Deep sea
- Sea state 2
- Wind speed < 10 knots
- Ambient temperature : 35°C
- Sea water temperature : 26°C

The propulsion is optimized for Trawling speed between 0,5 and 5,5 knots.

**1-2-5. Range**

The range is 10 days (with provisions for 12 days).

**1-2-6. Manœuvrability**

The ship is equipped with one rudder.  
 The rudder is actuated by a hydraulic steering gear.

Doc. Title	Ship Information Handbook		24 / 226
Doc. Reference	23,3 m Trawler		
Doc. Revision & Date	A - 15/09/14		



## 1-3. RULES AND STANDARDS

### 1-3-1. Rules

The ship is compliant with the following rules:

- More particularly its divisions 110, 211, 214, 217, 219 & 226; as far as Rule in appendix to the French Flag Authority Decree dated 23/11/1987 and practicable for this type of ship
- IMO Global Maritime Distress Safety System (GMDSS A1 +A2)
- International Tonnage measurement regulations (1969)
- The ship is marked according to COLREG regulations

The structure is designed according to Bureau Veritas classification society rules.

### 1-3-2. Certificates

Magnetic compass deviation curve.  
Stability and load line certificates.

### 1-3-3. Stability

The ship is divided in 5 watertight compartments (4 watertight bulkheads).

### 1-3-4. Applicable standards

All the equipments and the materials are in accordance with the applicable standards for this type of ship.

### 1-3-5. Quality insurance

CMN is certified ISO 9001 (V 2008) by the Bureau Veritas Quality International (BVQI).

Doc. Title	Ship Information Handbook		25 / 226
Doc. Reference	23,3 m Trawler		
Doc. Revision & Date	A - 15/09/14		

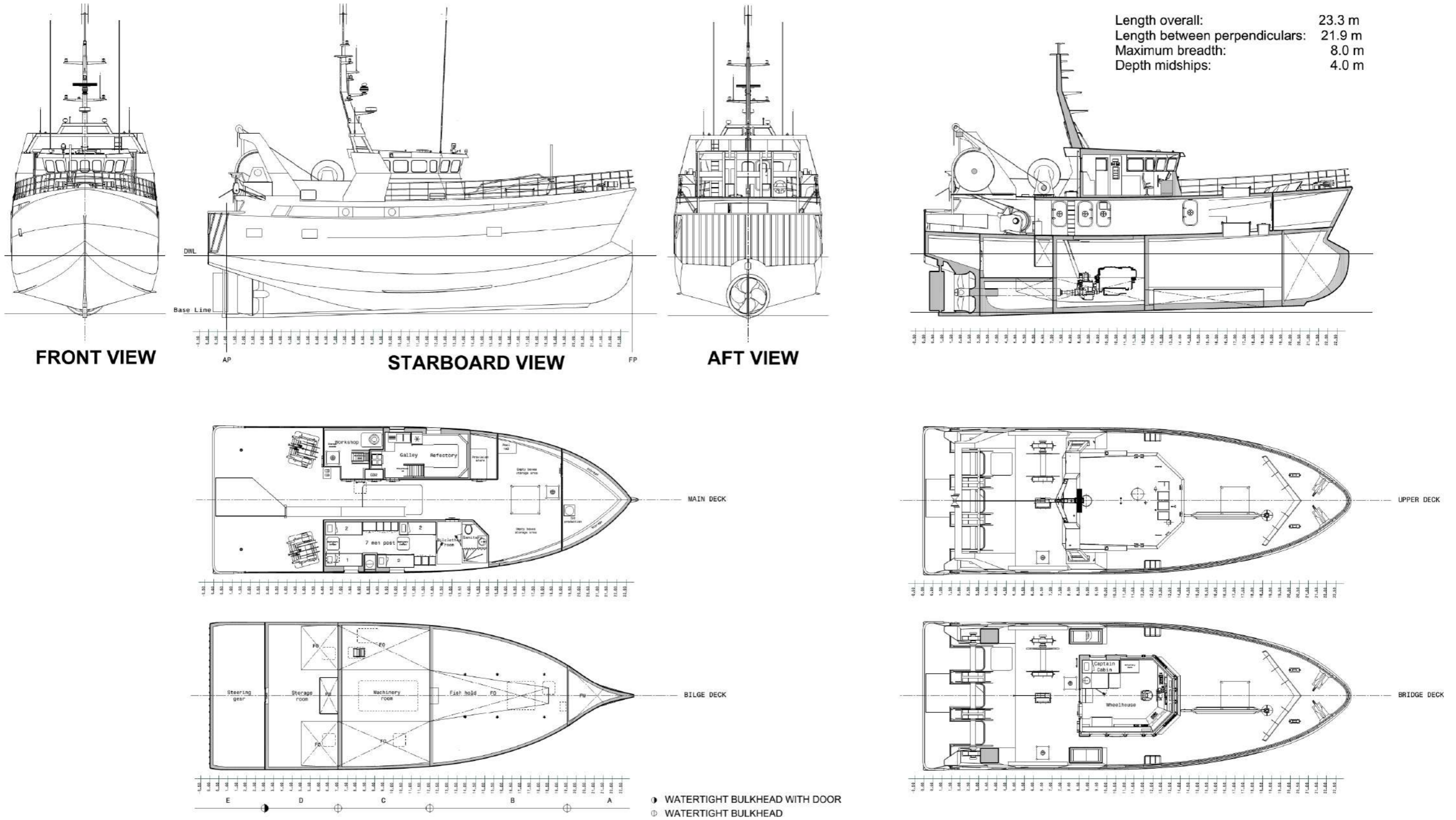

Doc. Title	Ship Information Handbook		26 / 226
Doc. Reference	23,3 m Trawler		
Doc. Revision & Date	A - 15/09/14		

© CMN group all rights reserved

Figure 1-1 General Arrangement

STARBOARD VIEW

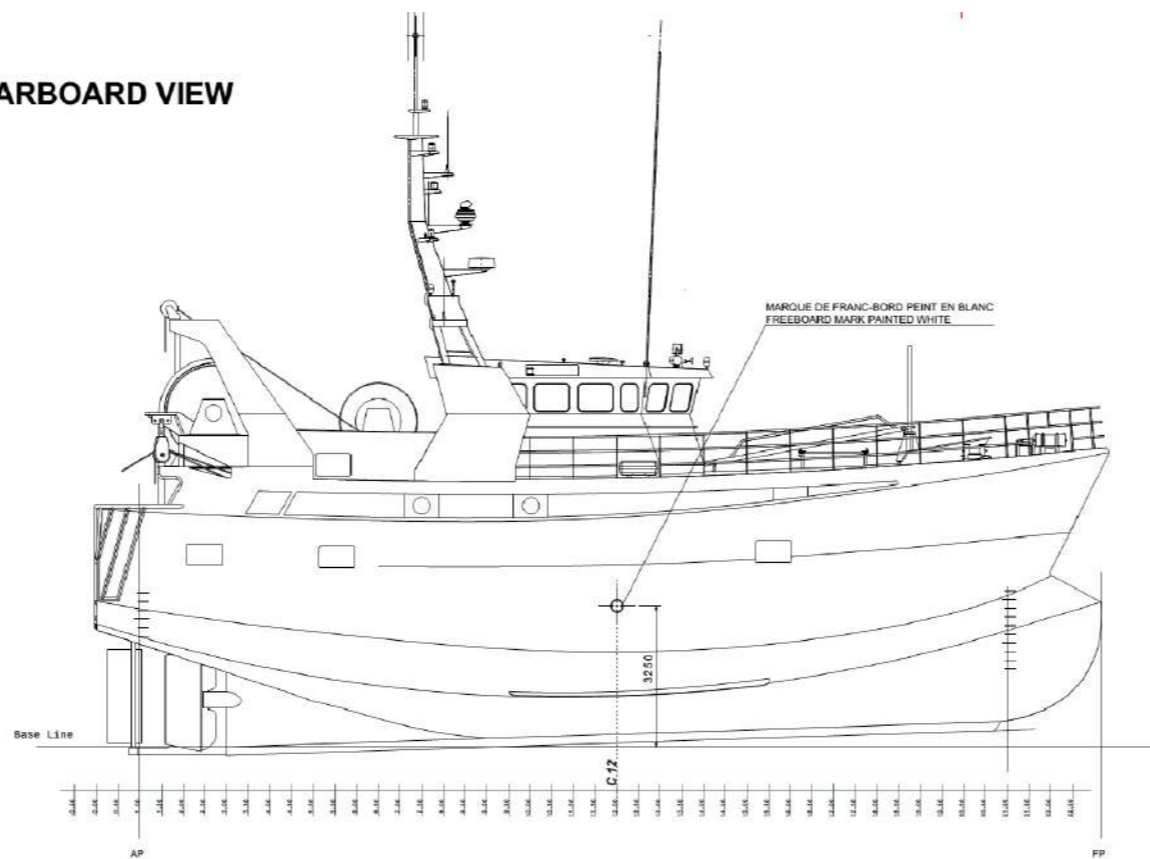

AFT VIEW

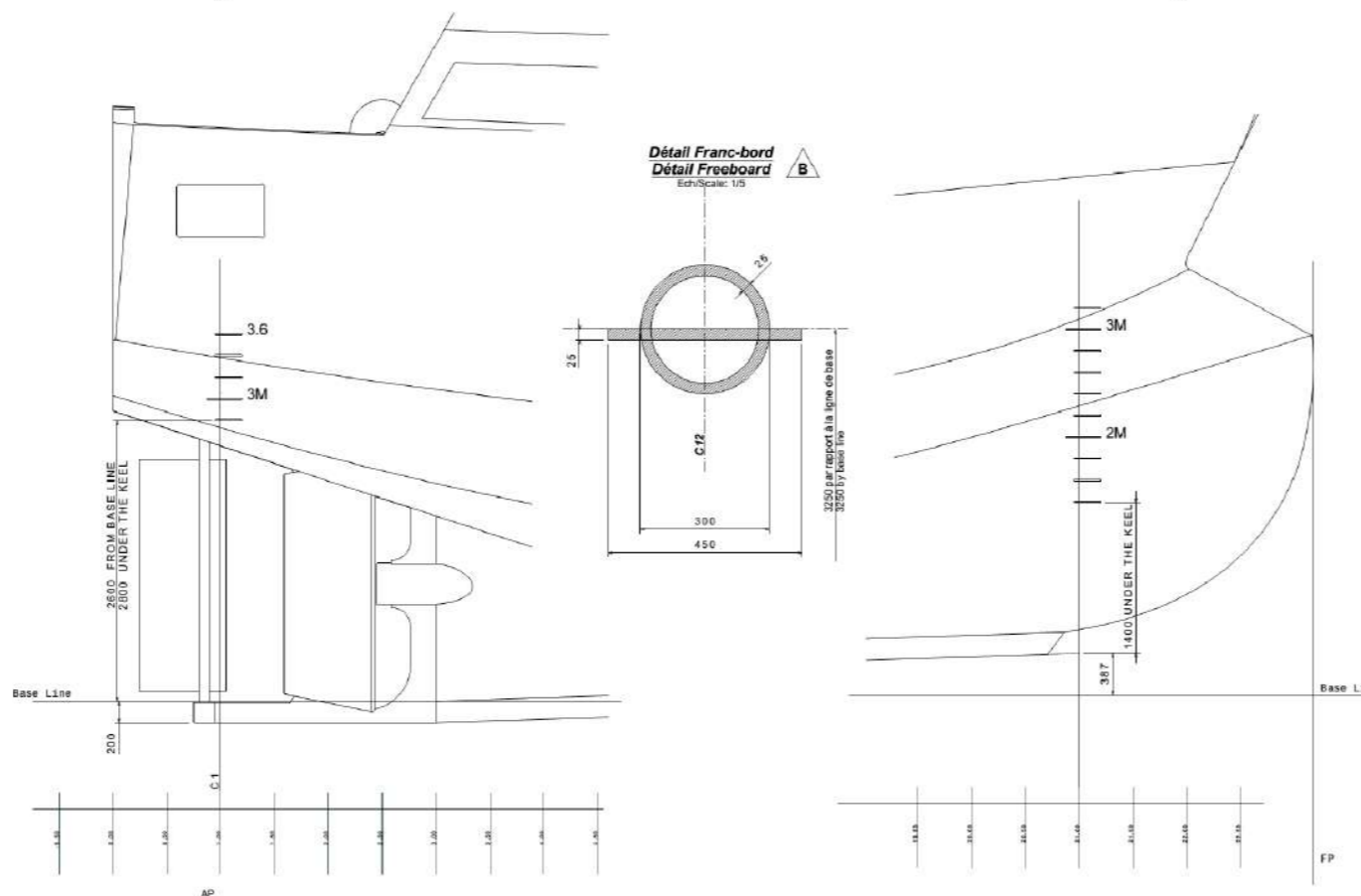
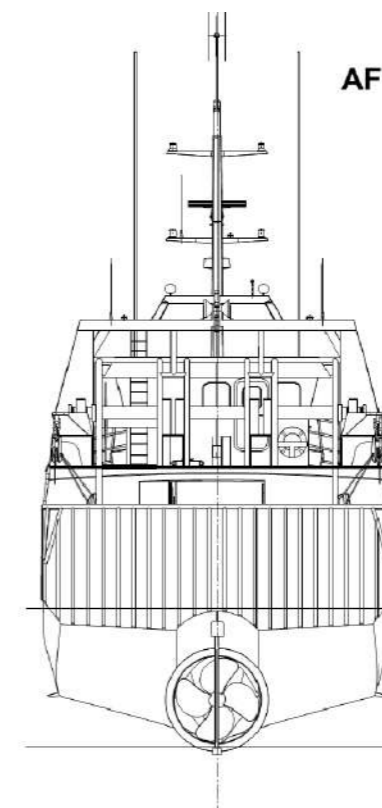

DETAIL

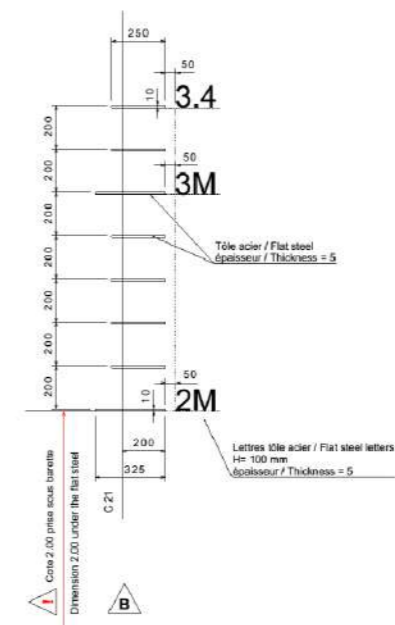

Doc. Title	Ship Information Handbook		27 / 226
Doc. Reference	23,3 m Trawler		
Doc. Revision & Date	A - 15/09/14		

© CMN group all rights reserved

Figure 1-2 - Draught Marks

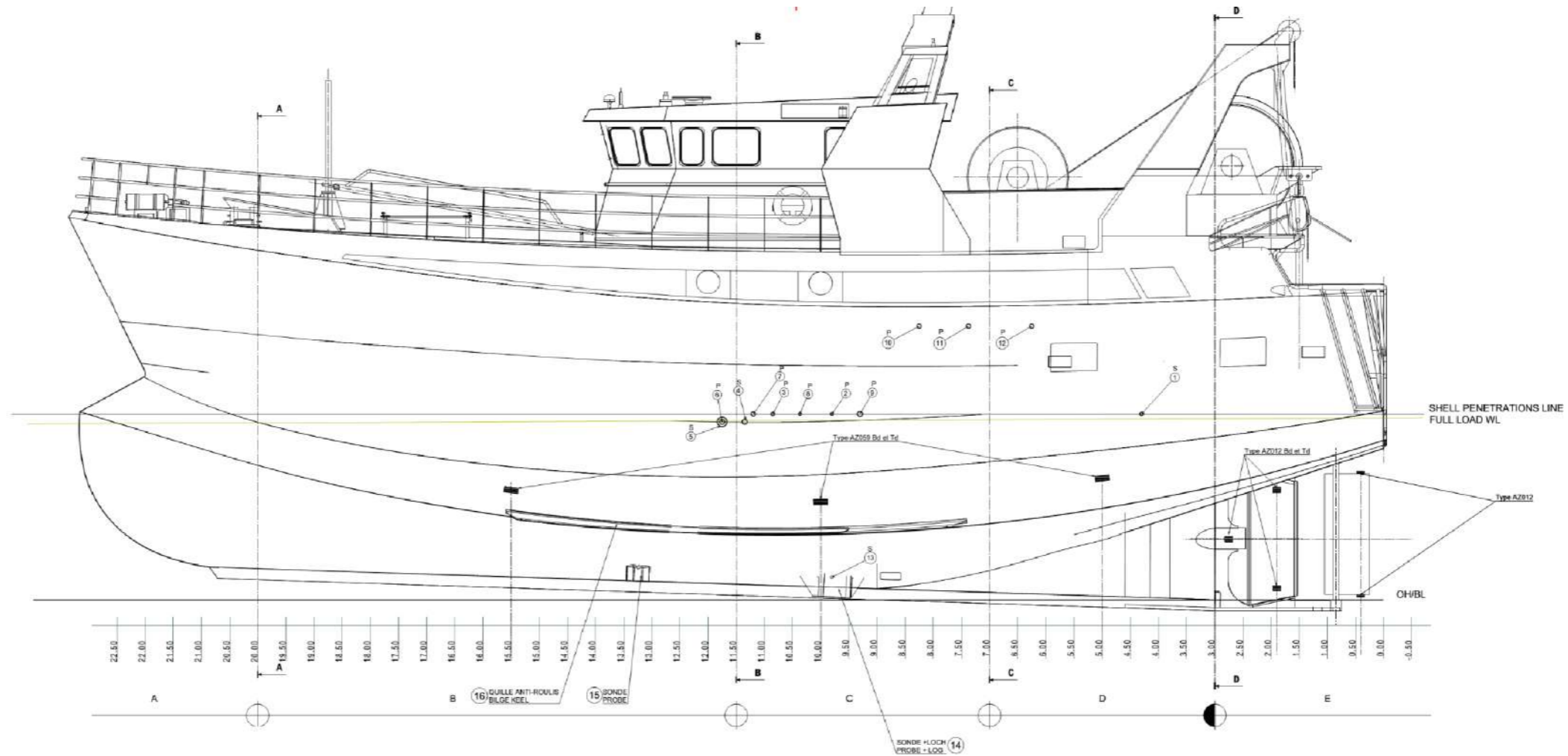

**VOIR PLAN / SEE DRAWING**  
132-F-Z00-T-34200-02

Rep:	Designations	POSITIONS		Positions par rapport aux coupes (après coupes) / Position from frame (between frames)	Position par rapport à la ligne de flottaison / Position from water line	
		Tribord / Starboard	Babord / Port		Dessus / Top	Dessous / Under
1	Pompe eau de mer / Sea water pump drinking	X		4 - 4.5	X	
2	Pompe eau de mer / Sea water pump drinking		X	9.5 - 10	X	
3	Evacuation pompe de vidange / Bilge pump discharge		X	10.5 - 11	X	
4	Evacuation eaux grises / Grey water discharge	X		11 - 11.5		X
5	Evacuation eaux noir / Black water discharge	X		11.5 - 12		X
6	Evacuation eaux grises / Grey water discharge		X	11.5 - 12		X
7	Raffigération moteur principal par eau de mer / Sea water cooling main engine		X	11 - 11.5	X	
8	Raffigération générateur électrique par eau de mer / Sea water cooling generator		X	10 - 10.5	X	
9	Raffigération hydraulique par eau de mer / Sea water cooling hydraulic		X	9 - 9.5	X	
10	Trap plein gazoil / Fuel-oil overflow		X	8 - 8.5	X	
11	Trap plein gazoil / Fuel-oil overflow		X	7 - 7.5	X	
12	Trap plein gazoil / Fuel-oil overflow		X	6 - 6.5	X	
13	Perçage pour LOG / Starboard hole for LOG	X	X	9.5 - 10		X
14	Sonde H-Loch / Probe - Log		X	9.5 - 10		X
15	Sonde / Probe	X		13 - 13.5		X
16	Quille Anti-roulis / Bilge keel	X	X	Delta: 7.41 soit 15.59		X

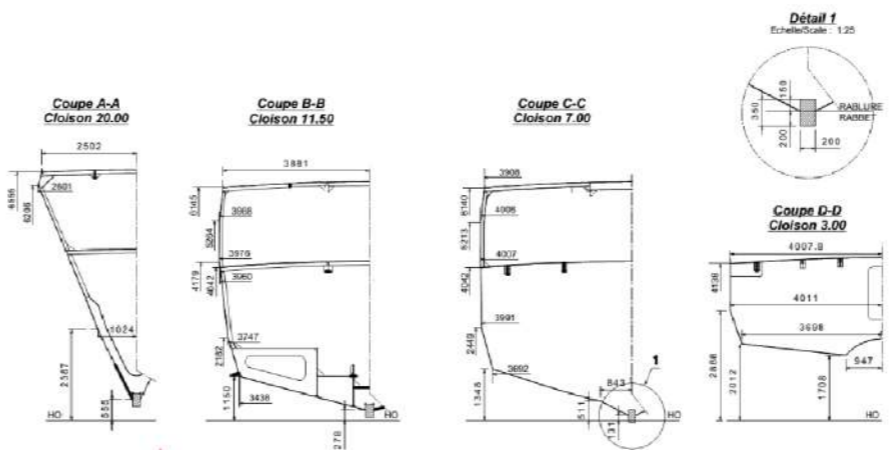

**VOIR PLAN / SEE DRAWING**  
132-F-Z00-S-2100-05

Designation	Type	Quantité & positions		
		Tribord / Starboard	Babord / Port	Axe
Ardoe	AZ012	3	3	2
Ardoe	AZ059	3	3	2

Doc. Title	Ship Information Handbook		28 / 226
Doc. Reference	23,3 m Trawler		
Doc. Revision & Date	A - 15/09/14		

© CMN group all rights reserved

Figure 1-3 Docking Plan

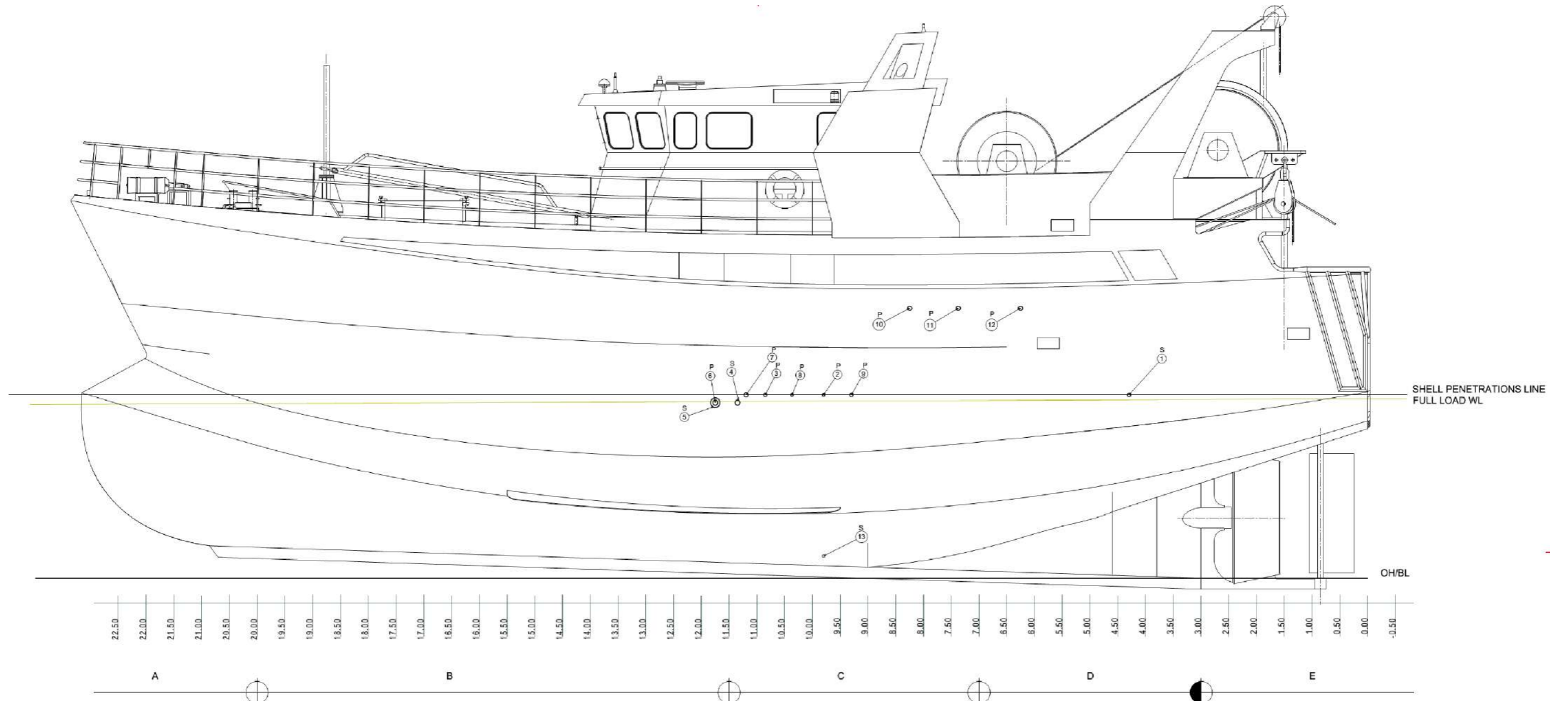

REP	Désignation	RCS
1	STARBOARD A/C unit sea water pump draining	324SR
2	PORT A/C unit sea water pump draining	324SR
3	PORT bilge pump discharge	333SE
4	STARBOARD grey water discharge	334SU
5	STARBOARD black water discharge	334SU
6	PORT grey water discharge	334SU
7	PORT sea water cooling main engine	575MM
8	PORT sea water cooling genset	575MM
9	PORT sea water cooling hydraulic	575MM
10	PORT fuel-oil overflow	33800
11	PORT fuel-oil overflow	33800
12	PORT fuel-oil overflow	33800
13	STARBOARD hole for LOG	631

Doc. Title	Ship Information Handbook		29 / 226
Doc. Reference	23,3 m Trawler		
Doc. Revision & Date	A - 15/09/14		

© CMN group all rights reserved

Figure 1-4 Shell Penetrations

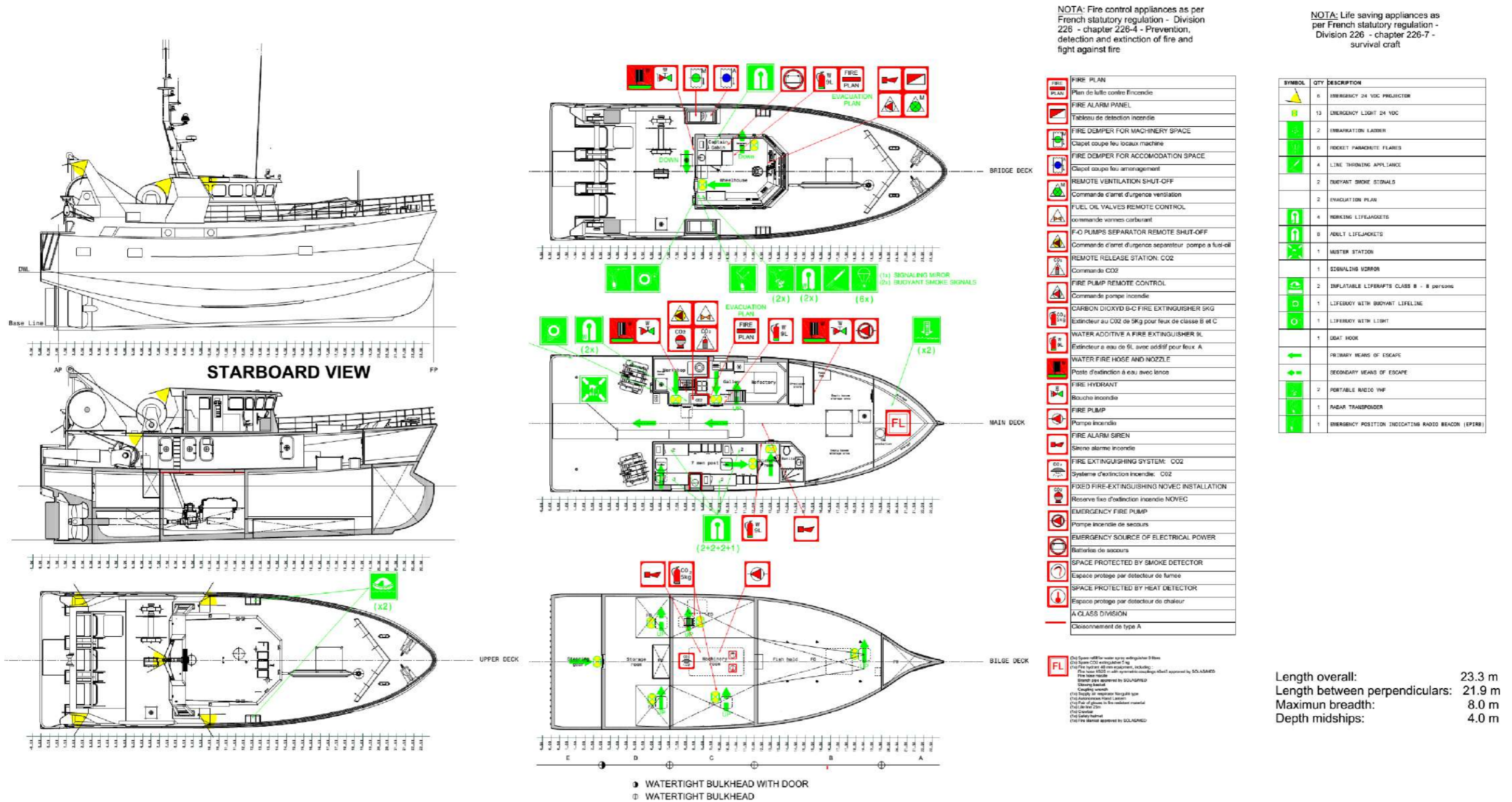

Length overall: 23.3 m  
 Length between perpendiculars: 21.9 m  
 Maximum breadth: 8.0 m  
 Depth midships: 4.0 m

Doc. Title	Ship Information Handbook		30 / 226
Doc. Reference	23,3 m Trawler		
Doc. Revision & Date	A - 15/09/14		

© CMN group all rights reserved

Figure 1-5 Life Saving

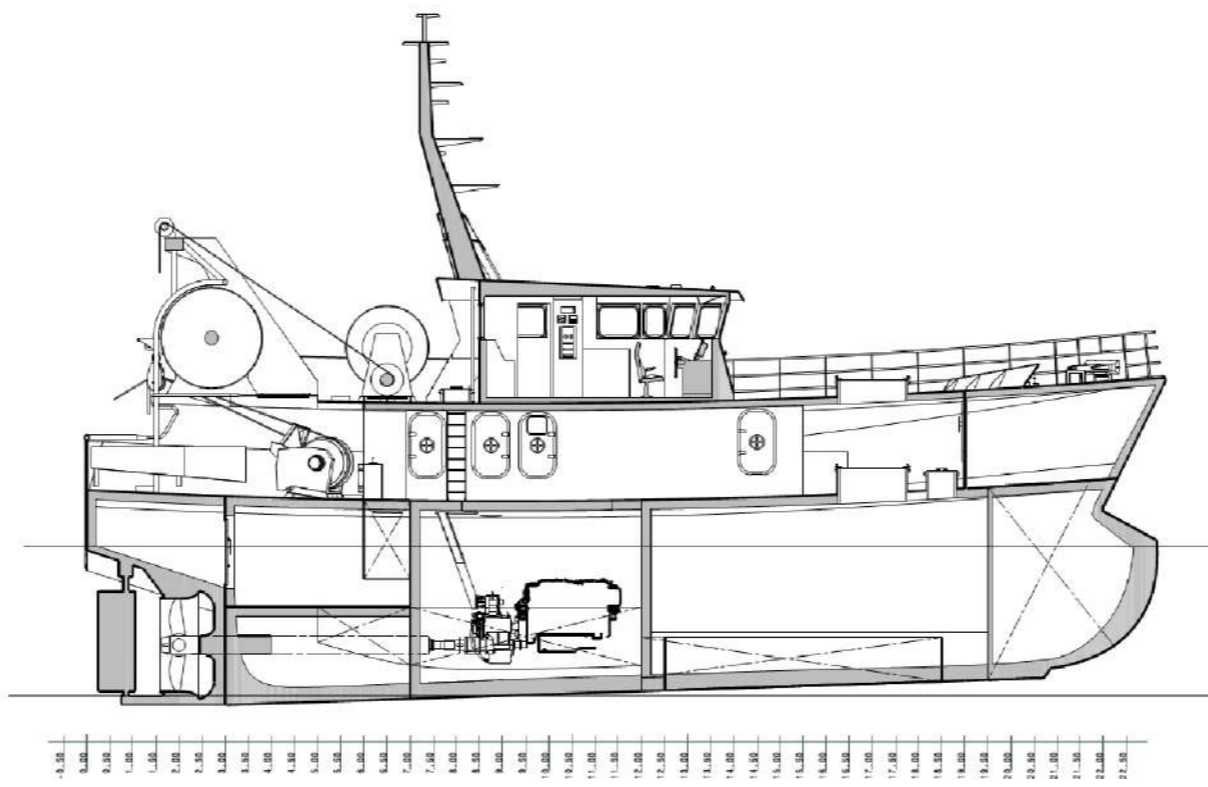
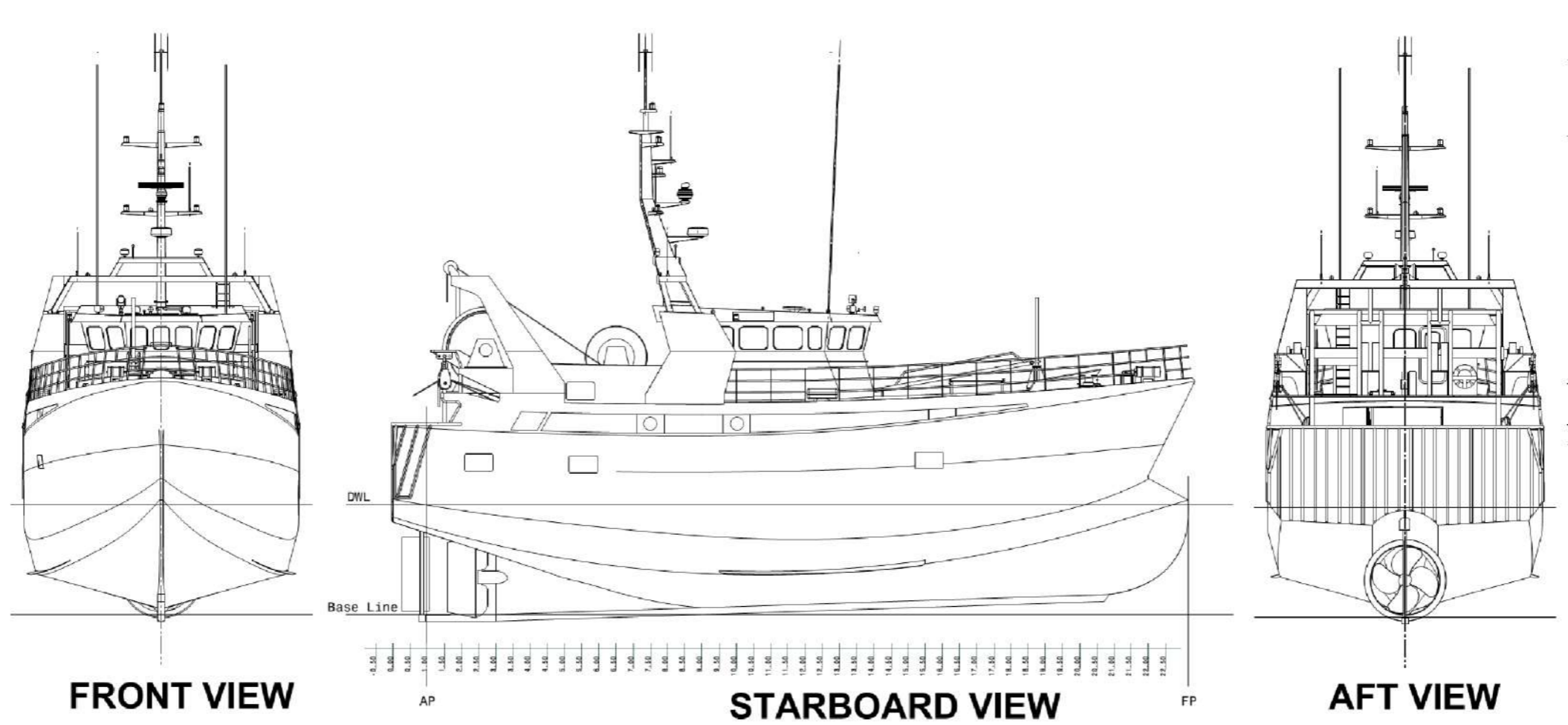

Length overall: 23.3 m  
 Length between perpendiculars: 21.9 m  
 Maximum breadth: 8.0 m  
 Depth midships: 4.0 m

Doc. Title	Ship Information Handbook		31 / 226
Doc. Reference	23,3 m Trawler		
Doc. Revision & Date	A - 15/09/14		

Figure 1-6 Outboard & Inboard Profiles

UPPER DECK



MAIN DECK

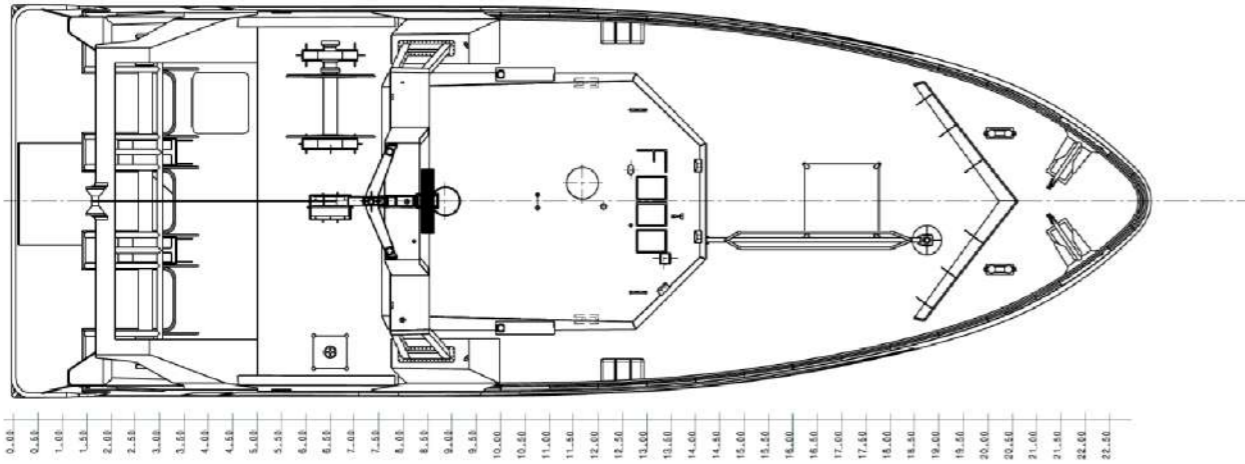
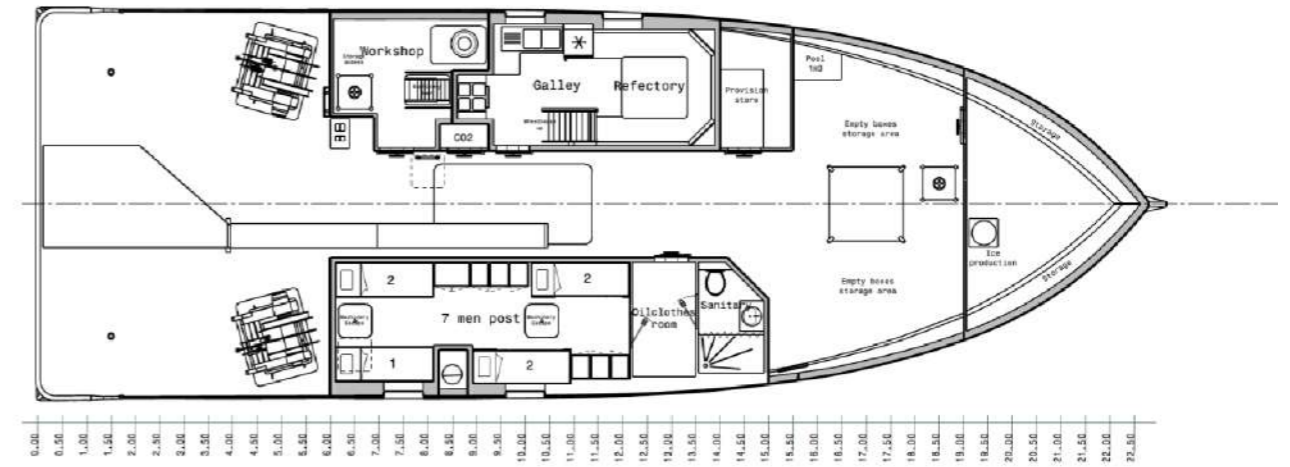

BRIDGE DECK

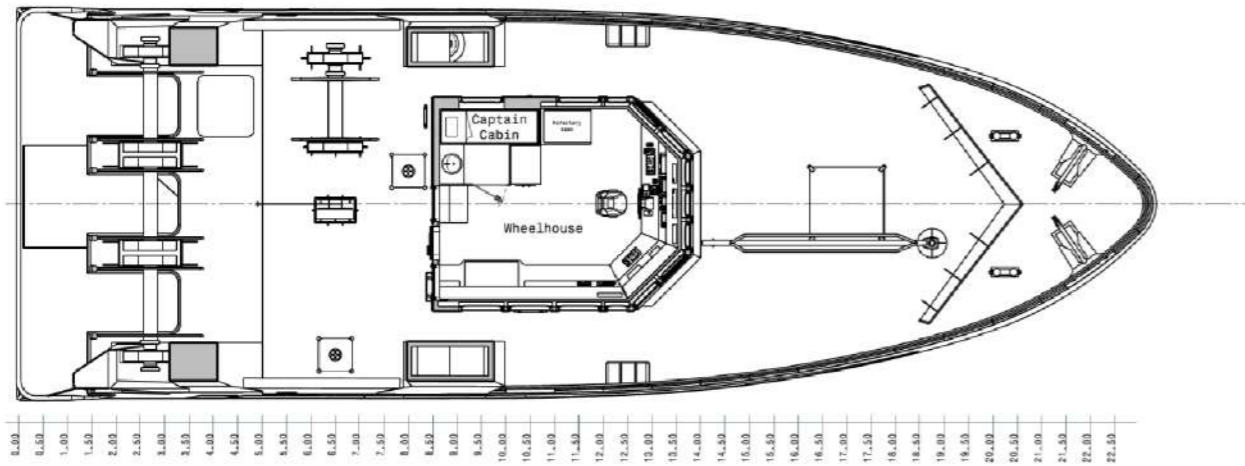

BILGE DECK

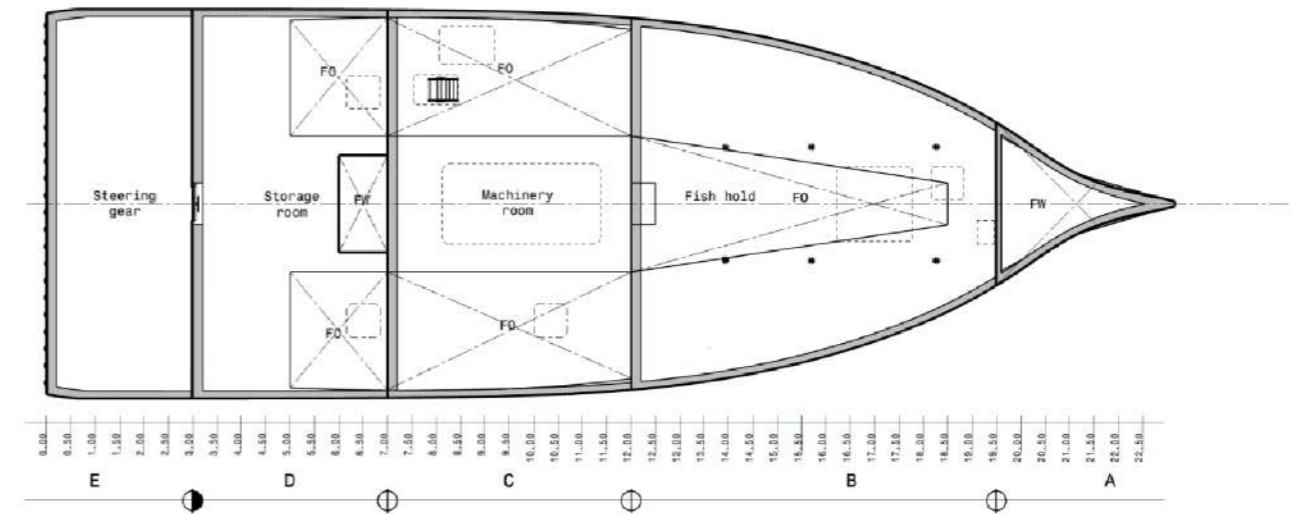

- WATERTIGHT BULKHEAD WITH DOOR
- WATERTIGHT BULKHEAD

Doc. Title	Ship Information Handbook		32 / 226
Doc. Reference	23,3 m Trawler		
Doc. Revision & Date	A - 15/09/14		

© CMN group all rights reserved

Figure 1-7 Outboard & Inboard Decks



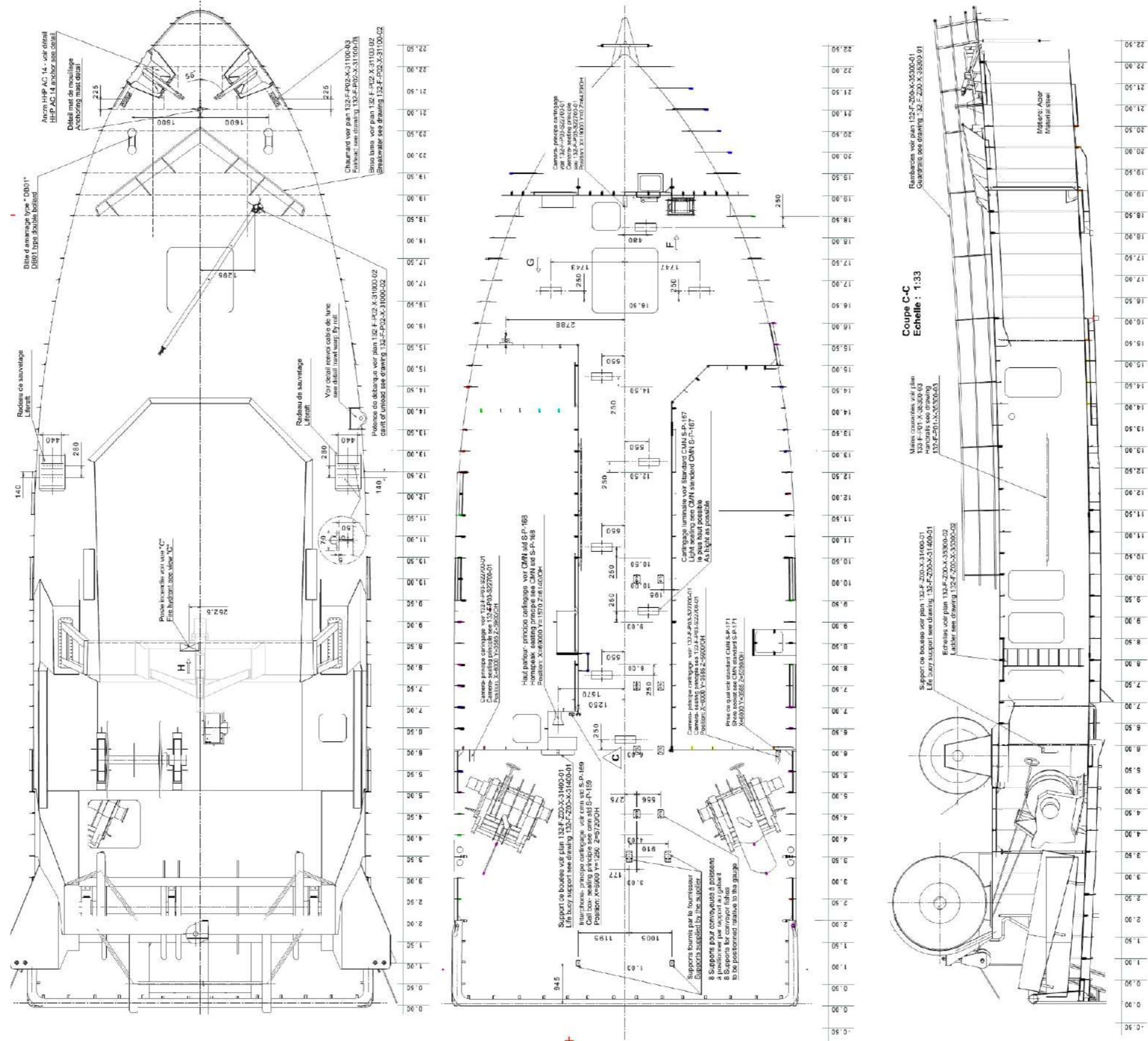

Doc. Title	Ship Information Handbook		33 / 226
Doc. Reference	23,3 m Trawler		
Doc. Revision & Date	A - 15/09/14		

© CMN group all rights reserved

Figure 1-8 Upper Decks Arrangement

**Tableau de description des portes / Door description table**

Numéro des portes / Door ref.	Étanchéité / Tightness		Clair d'ouverture / Clear opening (mm)	Dimension de découpe / Bulkhead opening (mm)	Surbau / Coaming (mm)	Forme / Shape		Matériaux / Material				Dormant / Frame			Ouverture / Opening			Isolation / Insulation		Tôle de doublage / Lining plate	Hublot / Vision panel	Tape sur hublot / Blind cover	Loquet / Door hasp (20)	
	Étanche à l'eau / Watertight	Étanche aux intempéries / Weathertight				Rectangle / Rectangular	Arrondie / Rounded	Porte / Door		Dormant / Frame		Montage / Mounting		Joint anti-feu / Fire seal	Charnières / Hinges		Coulis / Sliding	Motorisée / Powered	Classement feu / Fire classification					Isolation thermique / Thermal insulation
			Acier / Steel	Alu / Al. Alloy	Acier / Steel	Alu / Al. Alloy	Soudé / Welded	Boulonné / Bolted	Montage / Mounting	Gauche / Left	Droite / Right													
WD1		X	650 x 1500	700 x 1500 R125	300	X		X	X	X	X				X		X		X	X				X
WD2		X	650 x 1250	700 x 1300 R125	600	X		X	X	X	X				X									X
WD3		X	650 x 1250	700 x 1300 R125	600	X		X	X	X	X				X			X	X	X				X
WD4		X	650 x 1250	700 x 1300 R125	600	X		X	X	X	X													X
WD5		X	650 x 1250	700 x 1300 R125	600	X		X	X	X	X													X
WD6		X	650 x 1250	700 x 1300 R125	600	X		X	X	X	X							X	X	X				X
WD7	X		650 x 1350	700 x 1400 R125	500	X		X	X	X	X				X									X
WD8		X	650 x 1250	700 x 1300 R125	600	X		X	X	X	X				X									X

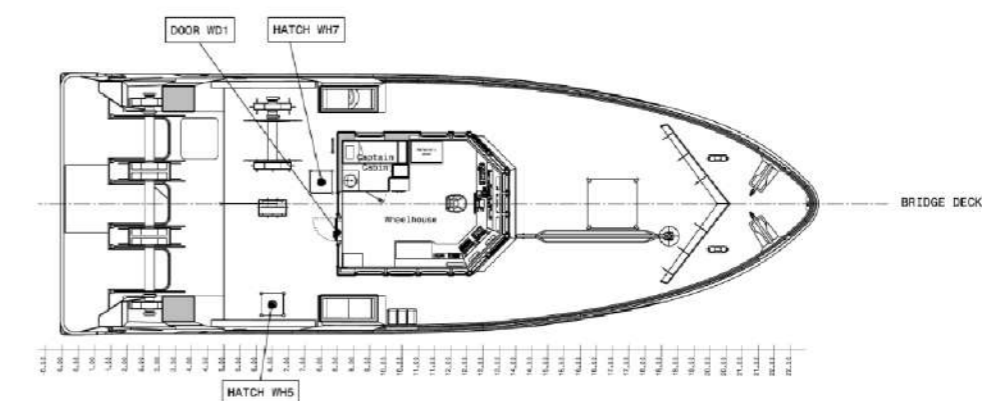
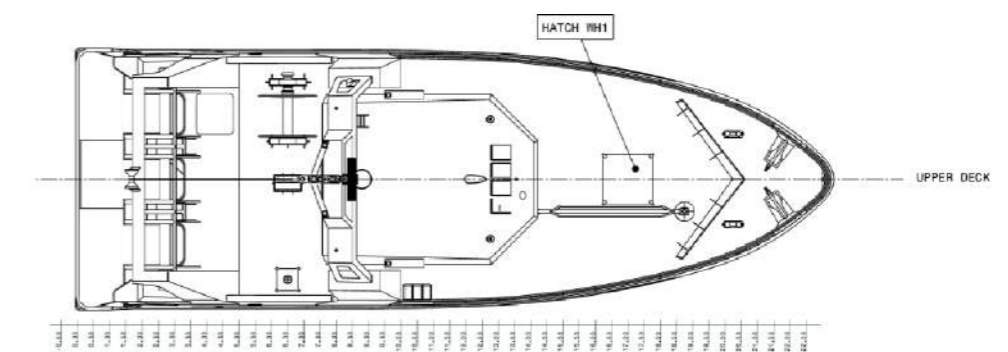
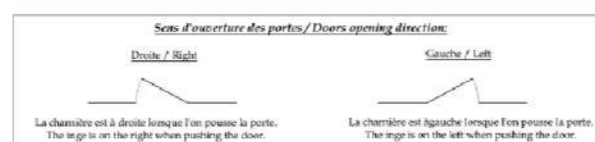

**Tableau de description des panneaux / Hatches description table**

Numéro des panneaux / Numbers	Surbau / Coaming (mm)	Clair d'ouverture / Clear opening (mm)	Dimension de découpe / Bulkhead opening (mm)	Forme / Shape			Matériaux / Material				Ouverture / Opening																	
				Carré / Square	Rectangle / Rectangular	Circulaire / Circular	Panneaux / Hatch		Surbau / Coaming	Assistance			Commande taquets / Latches operation			Charnières / Hinges				Arrêt / Blocking device	Classement feu / Fire classification	Isolation thermique / Thermal insulation	Tôle de doublage / Lining plate	Mortillon de cadenas / Padlock clip	Support de capteur de position / Position sensor stand			
							Acier / Steel	Alu / Al. Alloy		Acier / Steel	Alu / Al. Alloy	Ressort inox / Stainless steel spring	Contre poids / Counter weight	Verin pneumat. / Gas spring	Verin hydraul. / Hydraulic ram cylinder	Autres / Others	Commande individuelle / Individually clipped	Combinée par levier / Quick acting lever	Combinée par volant / Quick acting handwheel							Babord / Port	Tribord / Starboard	Avant / Bow
WH1	300 +50	1510 X 1510	1530 x 1530 R125	X			X	X								In / Out												
WH2	600 +50	1510 X 1510	1530 x 1530 R125	X			X	X								In / Out												
WH3	600 +50	630 x 630	650 x 650 R125	X			X	X								In / Out												
WH4	300 +50	630 x 630	650 x 650 R125	X			X	X								In / Out												
WH5	300 +50	630 x 630	650 x 650 R125	X			X	X								In / Out												
WH6	Flush	650 x 650	750 x 790 R150	X			X	X								In / Out												
WH7	300 +50	630 x 630	650 x 650 R125	X			X	X								In / Out												
WH8	Flush	650 x 650	750 x 790 R150	X			X	X								In / Out												

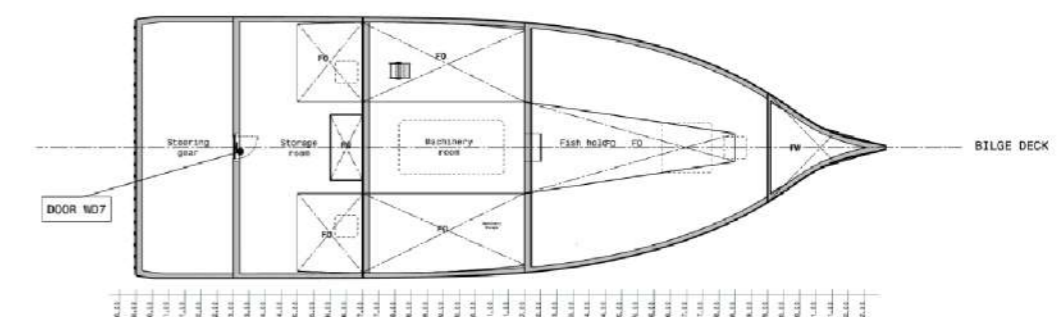

Doc. Title	Ship Information Handbook		34 / 226
Doc. Reference	23,3 m Trawler		
Doc. Revision & Date	A - 15/09/14		

© CMN group all rights reserved

Figure 1-9 Watertight Doors and Hatches Arrangement

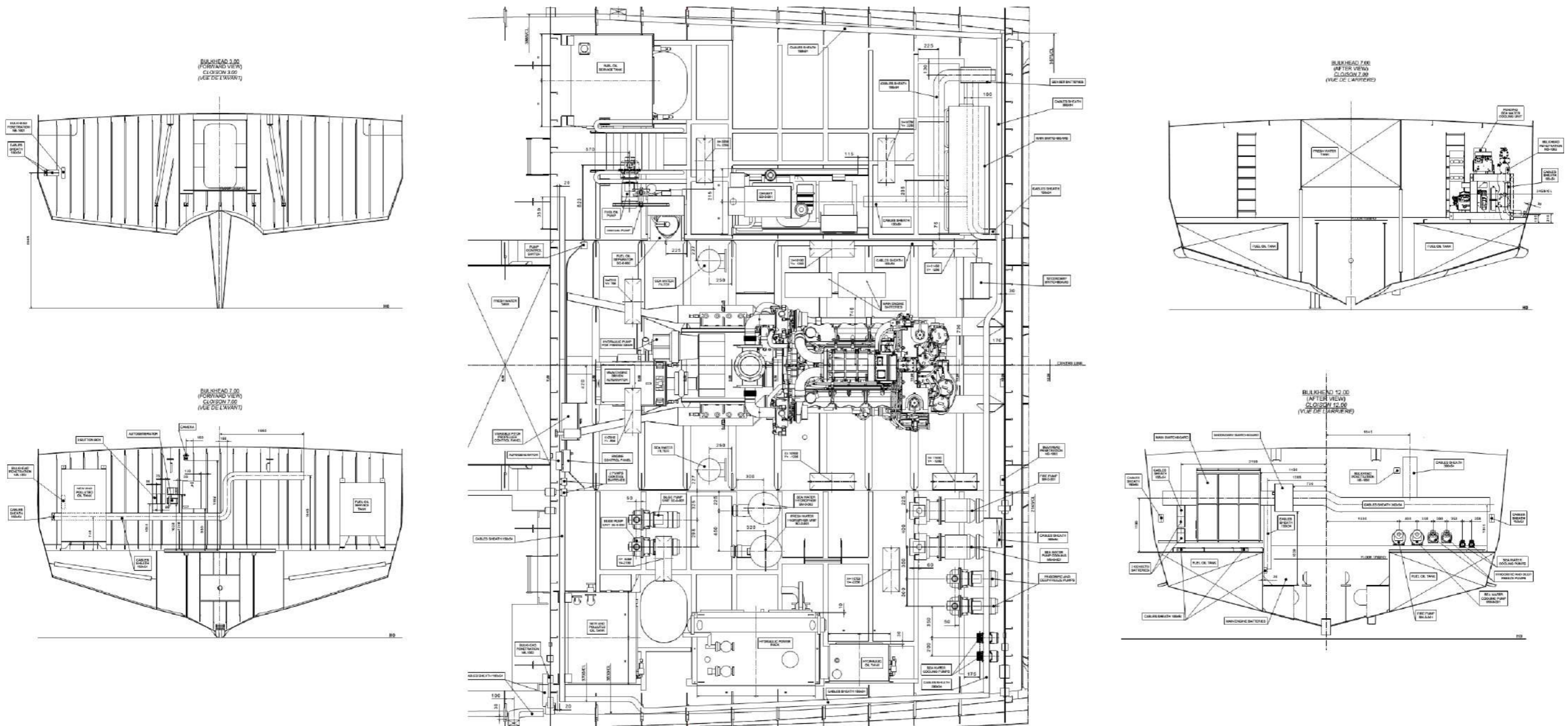

Doc. Title	Ship Information Handbook		35 / 226
Doc. Reference	23,3 m Trawler		
Doc. Revision & Date	A - 15/09/14		

© CMN group all rights reserved

Figure 1-10 Engine Room Arrangement

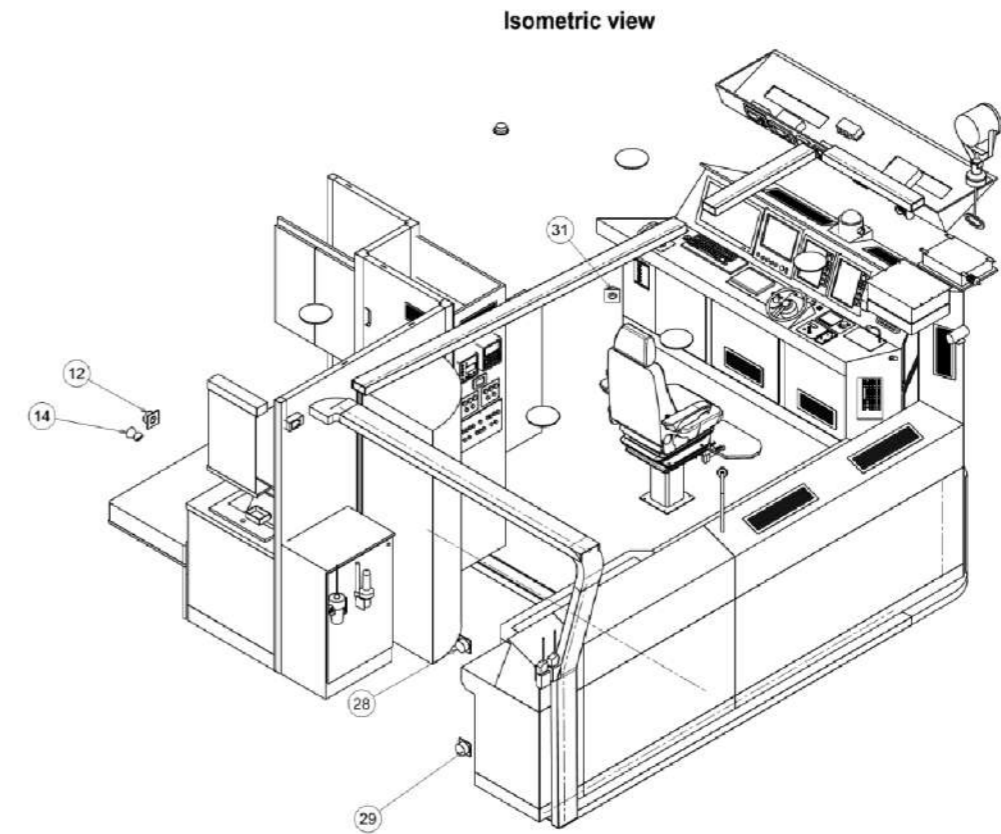
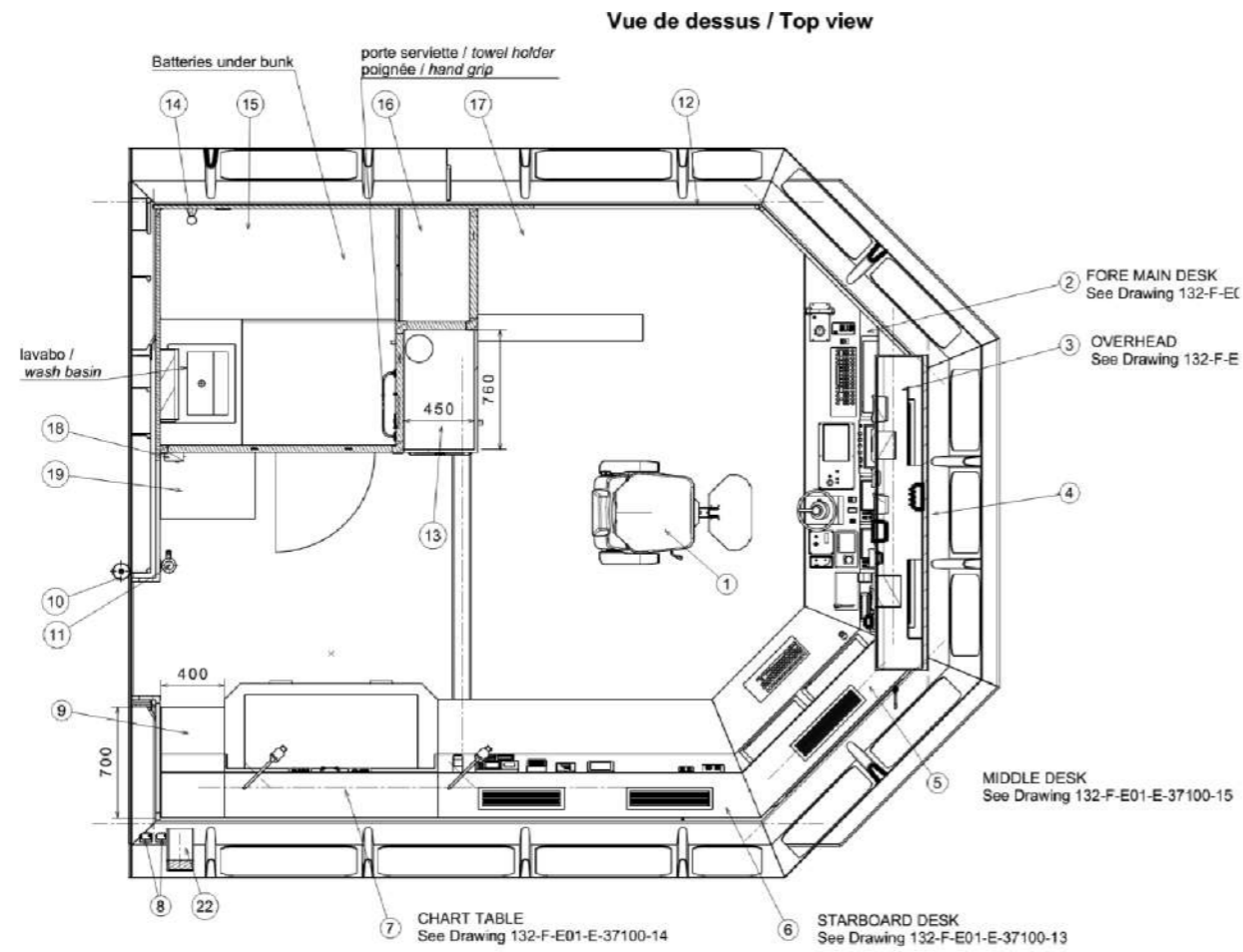

ID	DESIGNATION	NUMBER
1	HELSMAN SEAT	-
2	FORE MAIN DESK	-
3	OVERHEAD	-
4	MAGNETIC COMPAS	NL-0-003
5	MIDDLE DESK	-
6	STARBOARD DESK	-
7	CHART TABLE	-
8	2 VHF	-
9	FURNITURE	-
10	EPIRB	-
11	RADAR TRANSPONDER	-
12	230V SOCKET	EE-0-194/2
13	MISC EQUIPEMENT SWITCHBOARD	-

ID	DESIGNATION	NUMBER
14	BEDSIDE LIGHT	EE-0-135
15	BUNK WITH DRAWERS	-
16	HIGH STORAGE	-
17	STAIRS	-
18	VMS JUNCTION BOX	NL-0-060
19	FURNITURE	-
20	N/A	-
21	EMERGENCY LIGHTS	EB-0-111
22	CABLES TRAYS	-
23	HF TRANSCEIVER	NL-0-064
24	ANTENNA COUPLER	NL-0-065
25	N/A	-
26	SEARCH LIGHT HANDLER	-
27	FOG HORN COMPRESSOR	ES-0-004

Doc. Title	Ship Information Handbook		36 / 226
Doc. Reference	23,3 m Trawler		
Doc. Revision & Date	A - 15/09/14		

© CMN group all rights reserved

Figure 1-11 Wheelhouse Arrangement

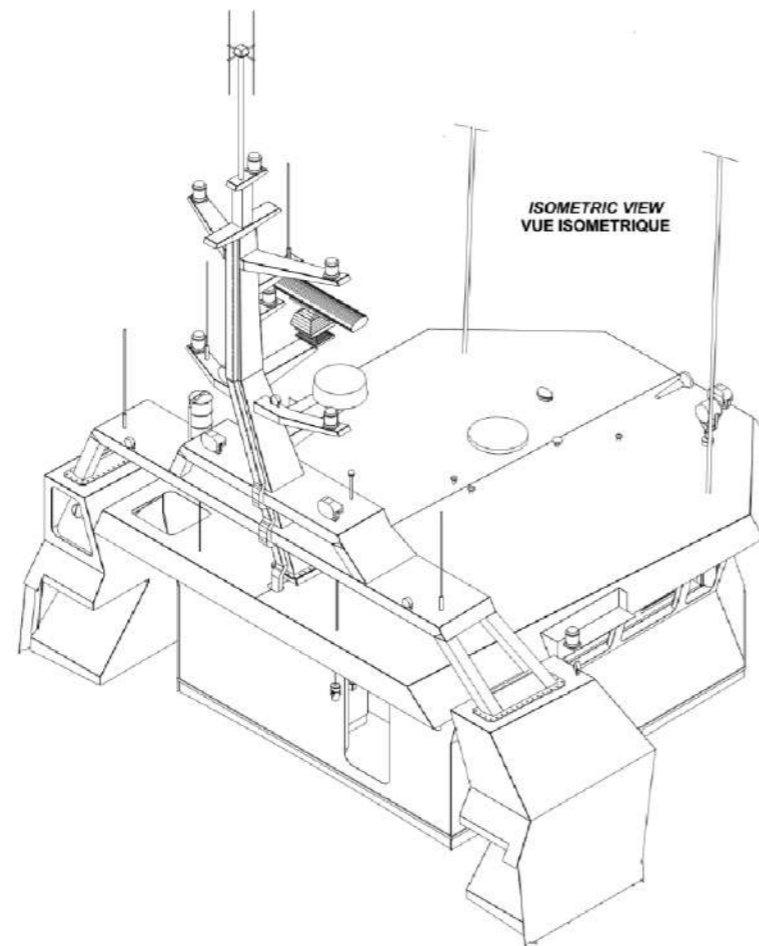
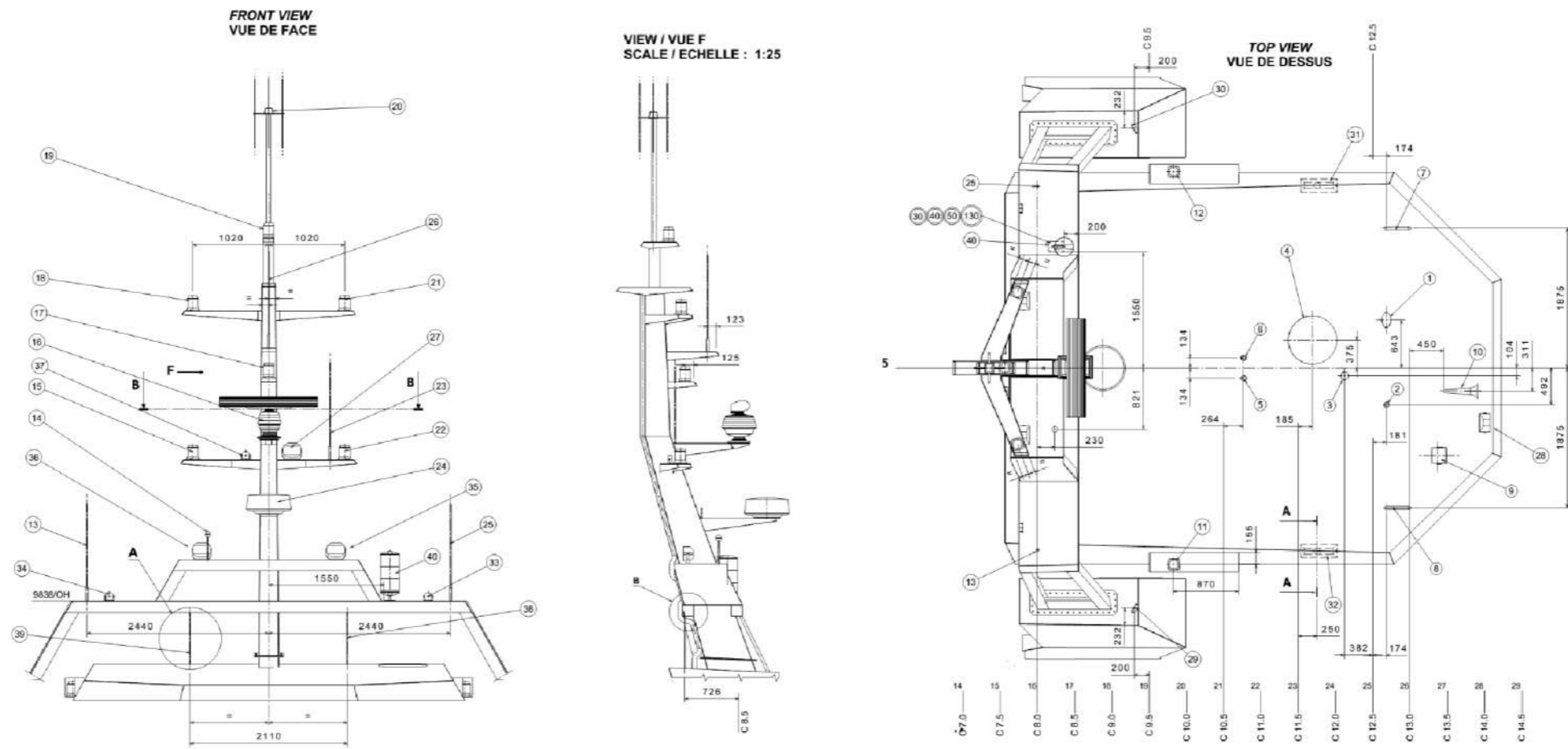

ID	DESIGNATION	NUMBER	SEATINGS DRAWING
1	VMS BEACOM	NL-0-061	133-F-Z00-U-22700-11
2	NAVTEX ANTENNA	NL-0-045	133-F-Z00-U-22700-03
3	AIS GPS ANTENNA	NL-0-031	133-F-Z00-U-22700-03
4	COMPASS SC-50 ANTENNA	NL-0-073	133-F-Z00-U-22700-09
5	GPS ANTENNA (SB)	NL-0-043	133-F-Z00-U-22700-03
6	GPS ANTENNA (PS)	NL-0-046	133-F-Z00-U-22700-03
7	HF/MF BLU ANTENNA (PS)	NL-0-028	133-F-Z00-U-22700-08
8	HF/MF BLU E/R ANTENNA (SB)	NL-0-029	133-F-Z00-U-22700-08
9	SEARCH LIGHT	EE-0-182	133-F-Z00-U-22700-10
10	FOGHORN MARCO	ES-0-004	133-F-Z00-U-22700-07
11	NAVIGATION LIGHT GREEN	ES-0-024	133-F-Z00-U-22700-15
12	NAVIGATION LIGHT RED	ES-0-021	133-F-Z00-U-22700-15
13	VHF/IMM FM8900 ANTENNA	NL-0-038	133-F-Z00-U-22700-02
14	WIND SENSOR ROW IND 133	NL-0-010	133-F-Z00-U-22700-16
15	NAVIGATION LIGHT RED	ES-0-007	133-F-Z00-U-22700-15
16	M1945 RADAR	NL-0-042	133-F-Z00-U-22700-01
17	NAVIGATION LIGHT WHITE	ES-0-016	133-F-Z00-U-22700-15
18	NAVIGATION LIGHT RED	ES-0-006	133-F-Z00-U-22700-15
19	NAVIGATION LIGHT WHITE	ES-0-005	133-F-Z00-U-22700-15
20	VHF ADDF ANTENNA	NL-0-050	133-F-Z00-U-22700-05
21	NAVIGATION LIGHT GREEN	ES-0-008	133-F-Z00-U-22700-15
22	NAVIGATION LIGHT WHITE	ES-0-009	133-F-Z00-U-22700-15
23	VHF/IMM FM8900 CH70 ANTENNA	NL-0-037	133-F-Z00-U-22700-02
24	M1835 RADAR	NL-0-044	133-F-Z00-U-22700-01
25	BASIC VHF ANTENNA	NL-0-027	133-F-Z00-U-22700-02
26	AIS VHF ANTENNA	NL-0-032	133-F-Z00-U-22700-02
27	PROJECTOR 750 W	EE-0-179	133-F-Z00-U-22700-06
28	PROJECTOR 750 W	EE-0-181	133-F-Z00-U-22700-06
29	PROJECTOR 80W	EB-0-129	133-F-Z00-U-22700-14
30	PROJECTOR 80W	EB-0-132	133-F-Z00-U-22700-14
31	LED DOWNLIGHT	EE-0-163	STANDARD S-P-167
32	LED DOWNLIGHT	EE-0-162	STANDARD S-P-167
33	PROJECTOR 80W	EB-0-130	133-F-Z00-U-22700-14
34	PROJECTOR 80W	EB-0-131	133-F-Z00-U-22700-14
35	PROJECTOR 750W	EE-0-178	133-F-Z00-U-22700-06
36	PROJECTOR 750W	EE-0-177	133-F-Z00-U-22700-06
37	PROJECTOR 80W	EB-0-135	133-F-Z00-U-22700-14
38	HALYARD (PS)		
39	HALYARD (SB)		
40	RADAR REFLECTOR		

Doc. Title	Ship Information Handbook		37 / 226
Doc. Reference	23,3 m Trawler		
Doc. Revision & Date	A - 15/09/14		

Figure 1-12– Mast Arrangement

## CHAPTER 2 – GENERAL ARRANGEMENT

### 2-1. GENERAL

The general arrangement of the ship is optimized for:

- The ergonomics at work for trawling activity
- Comfort (access to living areas)
- Security ( the crew work station is located on the fishing deck)
- Hygiene of the product

The arrangement of the living area is optimized with regards to the movements of the Ship while respecting safety regulations

The 23,3-Meter Trawler is divided into five below deck compartments, one main deck, and an upper level wheelhouse. The below deck areas are arranged as follows:

- the forepeak
- the fish hold room
- the engine room
- the storage room
- the steering gear room.

The main deck houses, the crew quarters and sanitary at stbd side and the galley, mess, workshop and provisions store at portside.

The crew workstation is located on the central part of main deck (here under referred as “fishing deck”), reducing the risks for the crew in case of emergency situations.

The upper bridge includes a steering and main engine remote control console complete with necessary navigation and communication equipment.

The mast is built in aluminium alloy and receives aerials and navigation lights according to the COLREG regulations for a Trawler under 24 m in length.

### 2-2. STEERING GEAR ROOM

The steering gear room includes mainly the following equipment:

- Two hydraulic cylinders
- Two HPU
- Oil tank with emergency steering wheel
- Two electrical cabinets (one for each HPU)

Doc. Title	Ship Information Handbook		38 / 226
Doc. Reference	23,3 m Trawler		
Doc. Revision & Date	A - 15/09/14		

### 2-3. STORAGE ROOM

The storage room includes mainly the following equipment:

- Fish hold and ice generator refrigerating unit
- Fwd stern tube of the propeller shaft
- Oil tank for Aft stern tube lubrication
- Two fishing gear distributors

### 2-4. ENGINE ROOM

The engine room includes mainly the following equipment:

- Main propulsion engine
- Reduction gearbox
- Shaft generator (driven by propulsion plant)
- Generator Set
- Fire pump
- Sea water cooling pump for fish hold and ice generator
- Oil tank for fishing gear
- Hydraulic Pump for fishing gear (driven by propulsion plant)
- Sea water cooling pump for HPU of fishing gear
- New and polluted oil tanks
- Two bilge pumps
- Two sea water strainers
- Oily water tank
- Fuel oil centrifugal separator
- Fuel oil transfer pump
- Fuel oil service tank
- Main electric switchboard
- Secondary electric switchboard
- Battery bank for ME starting
- Battery bank for Genset
- Fresh water pressure unit
- Sea water pressure unit

### 2-5. FISH HOLD

The fish hold room includes mainly the following equipment:

- Two cooling coils 3 x 1 m
- Two single cooling coils 2 x 1 m
- Two double cooling coils 2 x 1 m

Doc. Title	Ship Information Handbook		39 / 226
Doc. Reference	23,3 m Trawler		
Doc. Revision & Date	A - 15/09/14		

## 2-6. SANITARY ROOM

The sanitary room includes mainly the following equipment:

- Gravity toilet
- Wash basin
- Shower tray
- Water heater

## 2-7. GALLEY / MESS

The galley mainly includes the following equipment:

- Sink
- Hot plate
- Cooker
- Fridge
- Hood
- Water heater

## 2-8. CREW'S QUARTERS

The Crew's Quarters mainly includes the following equipment:

- Seven bunks equipped with drawers
- Seven berths

## 2-9. WORKSHOP

The workshop includes mainly the following equipment:

- Lub. oil tank of Fwd stern tube
- Secondary switchboard
- Remote control panel for fire pump

## 2-10. CO2 LOCKER

The CO2 locker includes mainly the following equipment:

- Two CO2 Bottles
- Manual Release
- Pneumatic release
- Two FO quick closing valves actuators

Doc. Title	Ship Information Handbook		40 / 226
Doc. Reference	23,3 m Trawler		
Doc. Revision & Date	A - 15/09/14		



## 2-11. FORE PEAK

The fore peak includes the following:

- Shelves to store various equipment
- Ice generator
- Fresh Water Feeding Pump

## 2-12. WHEELHOUSE

The wheelhouse mainly the following equipment:

- Pilot console including mainly:
  - Steering wheel
  - Engine control station
  - Engine remote control panel
  - Pitch propeller Remote Control Panel
  - Bridge Navigational Watch Alarm
  - Gearbox Clutching Panel
  - Autopilot panel
  - ECDIS monitor
  - Echosounder monitor
  - Two radar displays
  - Magnetic compass
  - Substation of Public Adress system
- Headband including mainly:
  - Satellite compass monitor
  - AIS transponder
  - Two rudder angle indicators
  - GPS
- Starboardside console including mainly:
  - Chart table
  - Two cartography monitors
  - Alarm panels
  - Navigation lights panel
- Aft portside panel including mainly:
  - Steering gear remote control panel
  - Generator remote control panel
  - Fire detection panel
  - ACU Control Panel
  - VHF Direction Finder
- Searchlight control handle
- Pilot seat

Doc. Title	Ship Information Handbook		41 / 226
Doc. Reference	23,3 m Trawler		
Doc. Revision & Date	A - 15/09/14		

## 2-13. CAPTAIN CABIN

The Captain Cabin mainly the following equipment:

- Bunk equipped with drawers
- Berth
- Cupboard

## 2-14. FISHING DECK

The aft deck includes mainly the following fishing equipment:

- Gantry including :
  - Dual net drum
  - Single net drum
  - Leading block
- Two warp winches
- Deck control panel of fishing gear
- Electrical control box
- One conveyor belt

## 2-15. FORE DECK

The fore deck includes mainly the following equipment:

- Electric winch for hoisting mast
- Two fish hold access hatches

## 2-16. BRIDGE DECK

The forward deck includes mainly the following equipment:

- Two Anchors of 255kg secured on cradles
- Anchoring line
- Breakwater
- Hoisting mast
- Technical fresh water filling connection
- Cable warp block
- Two liferafts
- Two flood lights 750 W
- Two flood lights 500 W

Doc. Title	Ship Information Handbook		42 / 226
Doc. Reference	23,3 m Trawler		
Doc. Revision & Date	A - 15/09/14		

## 2-17. UPPER DECK

The upper deck includes mainly the following equipment:

- One single net drum
- One Gilson winch
- Fresh water filling connection (Stbd mast foot)
- Fuel oil and new oil filling station and polluted oil and oily water discharge station (Port mast foot)

## 2-18. WHEELHOUSE HOOD

The wheelhouse hood includes mainly the following equipment:

- Searchlight
- Fog horn
- Compass antenna
- VMS beacon
- AIS antenna
- GPS antennae
- MIR 2000 antenna
- Port and Stbd navigation lights
- Flood lights 1000 W
- Flood lights 750 W

## 2-19. MAST

The mast includes mainly the following equipment:

- Two radar antennae
- VHF ADDF antenna
- Three floodlights 750W
- Five floodlights 80W
- Navigation lights

Doc. Title	Ship Information Handbook		43 / 226
Doc. Reference	23,3 m Trawler		
Doc. Revision & Date	A - 15/09/14		



Figure 2-1 Aft View of Ship



Figure 2-2 Mast and aerials



Figure 2-3 Wheelhouse External View

Doc. Title	Ship Information Handbook		44 / 226
Doc. Reference	23,3 m Trawler		
Doc. Revision & Date	A - 15/09/14		



Figure 2-4 Bridge Deck

Figure 2-5 Aft Deck - Gantry with Dual & Single Net Drums



Figure 2-6 Upper Deck - Gilson Winch

Doc. Title	Ship Information Handbook		45 / 226
Doc. Reference	23,3 m Trawler		
Doc. Revision & Date	A - 15/09/14		



Figure 2-7 Fishing Deck - Portside Warp



Figure 2-8 Portside Upper Deck - Single Net Drum

Doc. Title	Ship Information Handbook		46 / 226
Doc. Reference	23,3 m Trawler		
Doc. Revision & Date	A - 15/09/14		



Figure 2-9 Gantry - Leading Block



Figure 2-10 Gantry - 15 Tons Warp Block



Figure 2-11 Gantry - 6 Tons Warp Block



Figure 2-12 Stbd Upper Deck - Liferaft & Warp Cable Block

Doc. Title	Ship Information Handbook		47 / 226
Doc. Reference	23,3 m Trawler		
Doc. Revision & Date	A - 15/09/14		



Figure 2-13 Fishing Deck - Fishing Deck Control Panel

Figure 2-14 Fishing Deck - Fishing Gear Electrical Control Box



Figure 2-15 Fishing Deck - Fish Conveyor with Unloading Tank

Doc. Title	Ship Information Handbook		48 / 226
Doc. Reference	23,3 m Trawler		
Doc. Revision & Date	A - 15/09/14		





Figure 2-16 Fishing Deck - Fish Conveyor

Figure 2-17 Port Upper Deck - Shore Connections



Figure 2-18 Bridge Deck - Technical Fresh Water Filling Connection

Doc. Title	Ship Information Handbook		49 / 226
Doc. Reference	23,3 m Trawler		
Doc. Revision & Date	A - 15/09/14		



Figure 2-19 Stbd Upper Deck - Domestic Fresh Water Filling Connection



Figure 2-20 Wheelhouse - Fwd Console

Doc. Title	Ship Information Handbook		50 / 226
Doc. Reference	23,3 m Trawler		
Doc. Revision & Date	A - 15/09/14		



Figure 2-21 Wheelhouse – Corner and Stbd Console



Figure 2-22 Wheelhouse - Aft Console

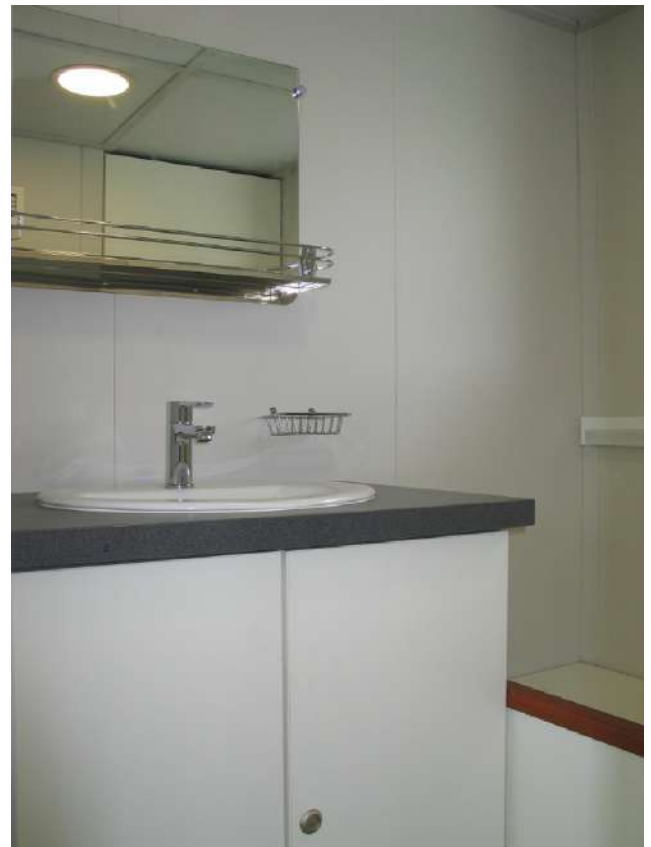

Figure 2-23 Captain Cabin

Doc. Title	Ship Information Handbook		51 / 226
Doc. Reference	23,3 m Trawler		
Doc. Revision & Date	A - 15/09/14		



Figure 24 Fore Peak



Figure 25 Fore Peak - Ice Generator



Figure 26 Galley - Cooker and Sink

Doc. Title	Ship Information Handbook		52 / 226
Doc. Reference	23,3 m Trawler		
Doc. Revision & Date	A - 15/09/14		



Figure 2-27 Galley - Sink and Refrigerator



Figure 2-28 Mess



Figure 2-29 CO2 Locker



Figure 2-30 Workshop - Storage Room Hatch

Doc. Title	Ship Information Handbook		53 / 226
Doc. Reference	23,3 m Trawler		
Doc. Revision & Date	A - 15/09/14		



Figure 2-31 Workshop – Aft Stern Tube  
Lub. Oil Tank



Figure 2-32 Crew Quarters - Entrance  
of Oilclothes Room



Figure 2-33 Crew Quarters - 7 Men Cabin



Figure 2-34 Crew Quarters - Sanitary

Doc. Title	Ship Information Handbook		54 / 226
Doc. Reference	23,3 m Trawler		
Doc. Revision & Date	A - 15/09/14		



Figure 2-35 Crew Quarters - Gravity Toilet



Figure 2-36 Fishing Deck - Aft Port Freeing Port



Figure 2-37 Fore Fishing Deck - Fish Hold Hatch

Doc. Title	Ship Information Handbook		55 / 226
Doc. Reference	23,3 m Trawler		
Doc. Revision & Date	A - 15/09/14		



Figure 2-38 Fore Fishing Deck - Electric Winch for Hoisting Mast

Figure 2-39 Steering Room – Rudder Stock & Steering Cylinders



Figure 2-40 Steering Room - Hydraulic Power Units

Doc. Title	Ship Information Handbook		56 / 226
Doc. Reference	23,3 m Trawler		
Doc. Revision & Date	A - 15/09/14		





Figure 2-41 Steering Room - Oil Tank, Double with Emergency Manual Pump



Figure 2-42 Storage Room - Refrigeration Plant for Fish Hold & Ice generator

Doc. Title	Ship Information Handbook		57 / 226
Doc. Reference	23,3 m Trawler		
Doc. Revision & Date	A - 15/09/14		



Figure 2-43 Storage Room - Hydraulic Distribution Block for Fishing Gear



Figure 2-44 Storage Room - Fore Shaft Seal Lub Oil Tank



Figure 2-45 Storage Room - Fore Stern Tube Seal and Propeller Shaft

Doc. Title	Ship Information Handbook		58 / 226
Doc. Reference	23,3 m Trawler		
Doc. Revision & Date	A - 15/09/14		



Figure 2-46 Engine Room - Main engine

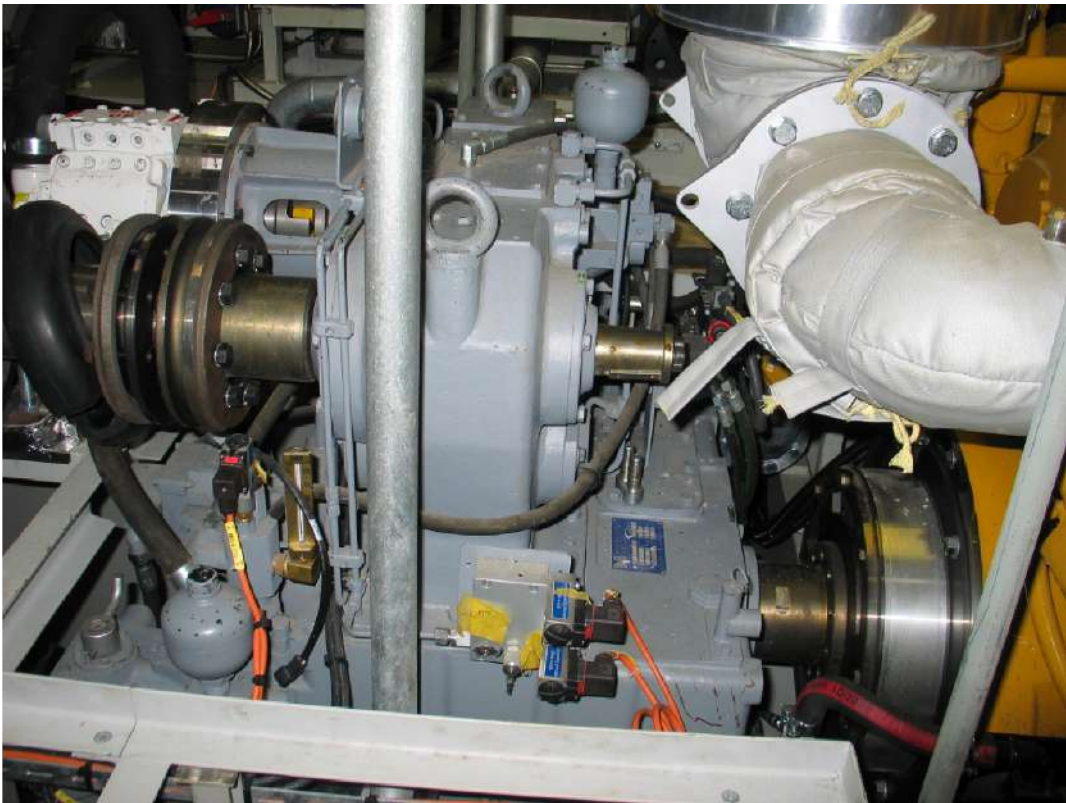

Figure 2-47 Engine Room - Reduction Gearbox

Doc. Title	Ship Information Handbook		59 / 226
Doc. Reference	23,3 m Trawler		
Doc. Revision & Date	A - 15/09/14		



Figure 2-48 Engine Room - 100 kVA Shaft Generator



Figure 2-49 Engine Room - HP Hydraulic Pump for Fishing Gear

Doc. Title	Ship Information Handbook		60 / 226
Doc. Reference	23,3 m Trawler		
Doc. Revision & Date	A - 15/09/14		



Figure 2-50 Engine Room - Generator Set



Figure 2-51 Engine Room - Fuel Oil Transfer Manifold

Doc. Title	Ship Information Handbook		61 / 226
Doc. Reference	23,3 m Trawler		
Doc. Revision & Date	A - 15/09/14		



Figure 2-52 Engine Room - Oil Tank for Hydraulic Fishing Gear



Figure 2-53 Engine Room - Fuel Oil Separator & Transfer Pump

Doc. Title	Ship Information Handbook		62 / 226
Doc. Reference	23,3 m Trawler		
Doc. Revision & Date	A - 15/09/14		



Figure 2-54 Engine Room - Fire Pump



Figure 2-55 Engine Room - Sea Water Cooling Pumps for Fish Hold Refrigeration Unit

Doc. Title	Ship Information Handbook		63 / 226
Doc. Reference	23,3 m Trawler		
Doc. Revision & Date	A - 15/09/14		



Figure 2-56 Engine Room -  
Sea & Fresh Water Pressure  
Pumps

Figure 2-57 Fish Hold  
Starboard Side



Figure 2-58 Fish Hold Portside

Doc. Title	Ship Information Handbook		64 / 226
Doc. Reference	23,3 m Trawler		
Doc. Revision & Date	A - 15/09/14		



# CHAPTER 3 – SHIP EQUIPMENT LIST

## 3-1. GENERAL INFORMATION

- The identification of the Maintenance Schedule is elaborated from the Ship Equipment List (SEL) which is the key data to properly use this maintenance manual.
- Both SEL and Maintenance Schedule are detailed following the four disciplines shown below:
  - Communication & Navigation
  - Electrical
  - Ancillaries of Hull (Fuel oil, Air Conditioning...)
  - Mechanical
- The content of the SEL details all equipment fitted on board with the useful information described below:
  - A single Ship Index by equipment, in order to have a good traceability in case of replacement
  - The description of the equipment
  - The name of the OEM
  - The name of the original supplier
  - The model, type or designation
  - The quantity fitted onboard
- Each system can be composed of only one part or several parts.
- The list of the different systems fitted onboard the craft is described below:
  - 210-00 Hull Cathodic Protection System
  - 310-00 Main Deck Arrangement
  - 312-00 Steering Gear
  - 314-00 Lifesaving
  - 322-00 Heating - Ventilation & Air Conditioning System (HVAC)
  - 324-00 A/C Sea Water Cooling System
  - 331-00 Fresh Water System
  - 332-00 Firemain System
  - 333-00 Bilge System
  - 334-00 Sewage & Sanitary System

Doc. Title	Ship Information Handbook		65 / 226
Doc. Reference	23,3 m Trawler		
Doc. Revision & Date	A - 15/09/14		

- 335-00 Marine Fuel Oil System
- 336-00 Lubricating Oil system
- 338-00 Air Vents, Sounding & overflow
- 341-00 Fire Detection system
- 341-10 CO2 Extinguishing system
- 342-00 Non Structural Tanks
- 350-00 Hatches / Doors & Windows
- 365-00 Galley
- 368-00 Refrigeration Plant for Fish Hold & Freezing Tunnel
- 371-00 Accommodation, Wheelhouse & Technical Rooms
- 410-00 AC 400V - 50Hz Electrical Network
- 412-00 Generator Set AC400V - 50Hz
- 420-00 DC 24V Electrical Network
- 440-00 Lighting System
- 448-00 Navigation Lights & Windscreen Wipers
- 470-00 Alarms & Safety
- 541-00 Propulsion Plant
- 543B00 Exhaust Plant
- 572B00 Controllable Pitch Propeller (CPP) and Transmission Shaft
- 575-00 Sea Water Cooling System
- 577-00 Propulsion & Gensets Remote Control & Monitoring Systems
- 610-00 Internal Communication System
- 620-00 External Communication System
- 630-00 Navigation System
- 900-00 Fishing Equipment

*Note : NC = Not Codified*

Doc. Title	Ship Information Handbook		66 / 226
Doc. Reference	23,3 m Trawler		
Doc. Revision & Date	A - 15/09/14		

### 3-2. SHIP EQUIPMENT LIST DETAIL

SHIP INDEX	EQUIP. INDEX	EQUIPMENT DESCRIPTION	MAKER	ORIGINAL SUPPLIER	MODEL / TYPE / DESIGNATION	NB OF UNITS
------------	--------------	-----------------------	-------	-------------------	----------------------------	-------------

#### 210-00 Hull

210-01	NC	Zinc Anode 1,2kg - Hull	Nochet	Nochet	AZ012	8
210-02	NC	Zinc Anode 5,9kg - Hull	Nochet	Nochet	AZ059	6
210-03	NC	Zinc Anode , single bolt, round plate 150 mm, Ø 30 mm thickness-Sea chest	Mondial Navys	Nochet	132-F-M01-P-210MM-01	2

#### 310-00 Main Deck Arrangement

310-01	NC	Port, Freeing	CMN	CMN	132-F-P01-X-31000-02	5
310-02	NC	Hoisting Mast	CMN	TSI	132-F-P02-X-31000-02	1
310-03	EE-0-200	Electric Winch AC220V 500kg	Huchez	Magi	TRC501CD9	1
310-04	NC	Bollard, Double	CMN	TSE	DB01	2
310-09	NC	Anchor AC14 255kg	Marit	Marit	AC14-255KG	2
310-10	NC	Anchoring Line	Marit	Marit		1

#### 312-00 Steering Gear

312-01	NC	Steering Unit	Fluidmecanica	Fluidmecanica	ST-1500-CS-P-35	1
312-02	QB-0-010 QB-0-020	Power Pack	Fluidmecanica	Fluidmecanica	9125	2
312-03	NC	Oil Tank, Double with Emergency Manual Pump	Fluidmecanica	Fluidmecanica	9891	1
312-06	QB-0-006	Tiller, Control, Steering Wheel	Kobelt	Fluidmecanica	MT-500-X	1
312-08	QB-0-001 QB-0-002	Starter, Electric	Fluidmecanica	Fluidmecanica	75CE721A	2
312-09	QB-0-003	Steering Remote Control Panel	Fluidmecanica	Fluidmecanica	980814A	1
312-10	NC	Rudder Stock	Fluidmecanica	Fluidmecanica	22163	1

#### 314-00 Lifesaving

314-01	NC	Inflatable Liferaft Flat 8 Men Pack B	Arimar	Arimar	8P-FLAT-PACK-B	2
314-02	NC	Hydrostatic Release Unit	Hammar	Arimar	H20	2

Doc. Title	Ship Information Handbook			67 / 226
Doc. Reference	23,3 m Trawler			
Doc. Revision & Date	A - 15/09/14			

SHIP INDEX	EQUIP. INDEX	EQUIPMENT DESCRIPTION	MAKER	ORIGINAL SUPPLIER	MODEL / TYPE / DESIGNATION	NB OF UNITS
------------	--------------	-----------------------	-------	-------------------	----------------------------	-------------

**322-00 Heating - Ventilation & Air Conditioning System**

322-01	SC-0-014	Fan Unit, Helicoïd - Air Exhaust	Enag	Enag	SEEM020097-VA167-50	1
322-02	SC-0-020 SC-0-023	Air Conditioning Unit 4,7kw	Webasto	Webasto	WBCL120004B	2
322-03	SC-0-026	Air Conditioning Unit 5,9kw	Webasto	Webasto	WBCL120005B	1
322-04	SC-0-022 SC-0-025 SC-0-028	Air Conditioning Units - Control Box	Webasto	Webasto	SS6S2-4	3
322-05	SC-0-012 SC-0-013	Fan Unit, Centrifugal 100/400m3/h	ATC	Ouest Isol	BCA160M	2
322-06	SC-0-21 SC-0-024 SC-0-027	Temperature Sensor	Webasto	Webasto		3

**324-00 A/C Sea Water Cooling System**

324B01	SR-0-001 SR-0-002	Sea Water Centrifugal Selfpriming E-Pump 15m3/h 20m	Azcue	SEMIM	CA-50/2A	2
324-02	SR-0-003	Sea Water E-Pump 1,2m3/h	Gianneschi	Webasto	WBCL001092A	1
324-03	SR-0-004	Sea Water E-Pump 1,2m3/h	Gianneschi	Webasto	WBCL001092A	1
324-04	SC-0-030	Relay Box - SW E-Pump	Webasto	Webasto	WBCL001127C	2

**331-00 Fresh Water System**

331-01	SD-0-001	Fresh Water Pressure Centrifugal E-Pump Unit 2,5m3/h 31,5m + 20 litre Receiver	Azcue	SEMIM	CP-25/160+	1
331-02	SD-0-002 SD-0-003	Electrical Water Heater 7,5kw - AC400V	Dafi	E-Citizen	7-5KW-AC400V	2
331-03	NC	Basket Filter DN40		Aquiro	600B-40	2
331-04	NC	Basket Filter DN25		Aquiro	600B-25	1
331-05	SD-2-004	Technical Fresh Water Self-Priming E-Pump 0,75kW	Tellarini	Seimi	ENM30	1

**332-00 Firemain System**

332-01	SM-0-001	Sea Water Centrifugal Selfpriming Main Firefighting E-Pump 25m3/h 30m	Azcue	SEMIM	CA-50/7A	1
332-02	SM-0-010	Remote Control Box - Fire Pump	SA2EI	SA2EI	132-F-M01-E-410EE-10	1
332-03	SM-0-002	Sea Water Pressure E-Pump Unit 2m3/h 22m + 20 litre Receiver	Azcue	SEMIM	MA-80+	1
332-04	NC	Emergency Hand Pump	Japy	Aquiro	BP3	1
332-05	NC	Zind plug, 50 mm length	CMN	CMN	53400001020	7

Doc. Title	Ship Information Handbook		68 / 226
Doc. Reference	23,3 m Trawler		
Doc. Revision & Date	A - 15/09/14		

SHIP INDEX	EQUIP. INDEX	EQUIPMENT DESCRIPTION	MAKER	ORIGINAL SUPPLIER	MODEL / TYPE / DESIGNATION	NB OF UNITS
------------	--------------	-----------------------	-------	-------------------	----------------------------	-------------

**333-00 Bilge System**

333-01	SE-0-001 SE-0-002	Bilge E-Pump 15m <sup>3</sup> /h 28m	Ascue	SEMIM	CA-50/3A	2
333-02	SE-0-010 SE-0-020	Remote Control Box - Bilge Pump	SA2EI	SA2EI	132-F-M01-E-410EE-10	2
333-03	NC	Bilge Hand Pump	Japy	Aquiro	BP2	1
333-04	NC	Mud Box DN50		Aquiro	7017-50	2
333-05	NC	Mud Box DN65		Aquiro	7017-65	1
333-06	NC	Mud Box DN80		Aquiro	7017-80	1
333-07	NC	Zinc plug, 65 mm length	CMN	CMN	53400001021	

**334-00 Sewage & Sanitary System**

334-01	NC	Gravity Toilet	Prezioso	Mabile		1
--------	----	----------------	----------	--------	--	---

**335-00 Marine Fuel Oil System**

335-01	SG-0-001	Fuel Oil Centrifugal Selfpriming Transfer E-Pump 10m <sup>3</sup> /h 20m	Japy	SEMIM	CA-50/2A	1
335-02	SG-0-010	Remote Control Box - Fuel Oil Transfer Pump	SA2I	SA2I	132-F-M01-E-410EE-10	1
335-03	SG-0-002	Centrifugal Water Separator Unit 760l/h	Alfa Laval	Alfa Laval	MIB 303S-13/33	1
335-04	NC	Emergency Hand Pump	Japy	Aquiro	HT 226	1
335-05	NC	Fuel Oil/Water Static Duplex Separator – for main engine	Parker Racor	Enéria	751000MAX	1
335-06	NC	Basket Filter DN50		Aquiro	601X50	1
335-07	NC	Basket Filter DN20		Aquiro	601X20	1
335-08	NC	Basket Filter DN65		Aquiro	601X65	1
335-09	NC	Hydraulic Pump Unit Station, Double for Quick Closing Valves	Aquiro	Aquiro	26-01-102	1
335-10	NC	Fuel Oil Sedimenter / Water - for Genset	Caterpillar	Enéria	36146	1

**336-00 Lub Oil System**

336-01	NC	Transfer Hand Pump	Japy	Aquiro	HT1	1
336-02	NC	Basket Filter DN40		Aquiro		1

Doc. Title	Ship Information Handbook		69 / 226
Doc. Reference	23,3 m Trawler		
Doc. Revision & Date	A - 15/09/14		

SHIP INDEX	EQUIP. INDEX	EQUIPMENT DESCRIPTION	MAKER	ORIGINAL SUPPLIER	MODEL / TYPE / DESIGNATION	NB OF UNITS
------------	--------------	-----------------------	-------	-------------------	----------------------------	-------------

**338-00 Air Vents, Sounding & Overflow**

338-01	NC	Aseptic Filter	nterfiltre	Interfiltre	601X40	3
--------	----	----------------	------------	-------------	--------	---

**341-00 Fire Detection system**

341-01	SI-0-006	Converter AC230V/ DC24V		Technitronic	LAMBDA	2
341-02	SI-0-001	Fire Detection Panel	Marinelec	Marinelec	DI09	1
341-03	SI-0-002 SI-0-003	Heat / Smoke Sensor	Marinelec	Marinelec	TMCA+EMBCAO+ KITSEAP	2
341-04	SI-0-004	Siren & Flashlight	Marinelec	Marinelec		1
341-05	SI-0-005	Siren	Marinelec	Marinelec	SIRENE24VDC107DBBP	1

**341-10 CO2 Extinguishing system**

341-11	NC	Cylinder 50 litre with 33kg CO2 Charge	Tyco	Tyco	13 052 121 8	2
341-12	NC	Cylinder Valve Manual / Pneumatic	Tyco	Tyco	CO-2011	2
341-13	NC	Audible / Visual Alarm	Fulleon	Tyco	20-118	2

**342-00 Non Structural Tanks**

342-01	NC	New & Waste Lub Oil Tank	CMN	CMN	132-F-M01-T-34200-01	1
342-02	NC	Hydraulic Oil Tank	CMN	CMN	132-F-M01-T-34200-03	1
342-03	NC	Marine Fuel Oil Service Tank	CMN	CMN	132-F-M01-T-34200-04	1
342-04	NC	Oily Water Tank	CMN	CMN	132-F-M01-T-34200-05	1

**350-00 Hatches / Doors & Windows**

350B0 1	NC	Engine Removal Hatch	CMN	CMN	132-F-Z00-S-35000-01	1
350-02	NC	Watertight Access Hatch 1480x1480mm	Libra Plast	Libra Plast	WH1-2	2
350-03	NC	Watertight Access Hatch 630x630mm	Libra Plast	Libra Plast	WH3-4-5-7	4
350-05	NC	Watertight Access Hatch 650x650mm	Libra Plast	Libra Plast	WH6-8	2
350-08	NC	Watertight Access Aluminium Door 650x1500mm	Libra Plast	Libra Plast	WD1	1
350-09	NC	Watertight Access Steel Door 650x1250mm	Libra Plast	Libra Plast	WD2	1
350-10	NC	Watertight Access Steel Door 650x1250mm with Porthole	Libra Plast	Libra Plast	WD3	1

Doc. Title	Ship Information Handbook		70 / 226
Doc. Reference	23,3 m Trawler		
Doc. Revision & Date	A - 15/09/14		

SHIP INDEX	EQUIP. INDEX	EQUIPMENT DESCRIPTION	MAKER	ORIGINAL SUPPLIER	MODEL / TYPE / DESIGNATION	NB OF UNITS
350-11	NC	Watertight Access Steel Door 650x1250mm	Libra Plast	Libra Plast	WD4	1
350-12	NC	Watertight Access Steel Door 650x1250mm	Libra Plast	Libra Plast	WD5	1
350-13	NC	Watertight Access Steel Door 650x1250mm with Porthole	Libra Plast	Libra Plast	WD6	1
350-14	NC	Watertight Access Hatch 650x1350mm	Libra Plast	Libra Plast	WD7	1
350-15	NC	Porthole 350/400mm	La Auxiliar Naval	La Auxiliar Naval	SC 1-2-3-4	4
350-16	NC	Window 510x710mm - Heating AC230V	La Auxiliar Naval	La Auxiliar Naval	GA 1-2-3	3
350-17	NC	Window 660x710mm - Heating AC230V	La Auxiliar Naval	La Auxiliar Naval	GB 1-2-3-4	4
350-18	NC	Window 445x710mm	La Auxiliar Naval	La Auxiliar Naval	GB 1-2	2
350-19	NC	Window 860x710mm	La Auxiliar Naval	La Auxiliar Naval	GB 1-2-3-4-5	5
350-20	NC	Window 660x685mm	La Auxiliar Naval	La Auxiliar Naval	GB 1-2	2

**365-00 Galley**

365-01	QC-0-003	Hot Plates	Electrolux	Mabille	EHS6940HOX	1
365-02	QC-0-001	Cooker	Faure	Mabille	FOP27901XB	1
365-03	QC-0-002	Fridge	Bosch	Mabille	KDV33VL30	1
365-04	SC-0-017	Hood	Faure	Mabille	FHT6141X	1
365-05	NC	Sink, Stainless Steel, 1160x500mm	Franke	Mabille	6464	1

**368B00 Refrigeration Plant for Fish Hold & Freezing Tunnel**

368B01	NC	Fish Hold Chiller - Reciprocating Compressor	Bitzer	Paumier	4EES-4Y	1
368B02	NC	Fish Hold Chiller - Condenser	Bitzer	France Agro Ind.	K373HB	1
368B03	NC	Fish Hold Chiller – Filter Dryer	Bitzer	France Agro Ind.	DCR0485S	1
368B04	NC	Fish Hold Chiller – Oil Separator	Bitzer	France Agro Ind.		1
368B05	NC	Ice Generator Refrigerating Plant - Reciprocating	Bitzer	France Agro Ind.	4CES-6Y-40S	1
368B06	NC	Ice Generator Refrigerating Plan - Condenser	Bitzer	France Agro Ind.	K573HB	1
368B07	NC	Ice Generator Refrigerating Plan - Filter Dryer	Bitzer	France Agro Ind.	DCR0485S	1
368B08	NC	Ice Generator Refrigerating Plan - Oil Separator	Bitzer	France Agro Ind.		1
368B09	QV-0-100	Electrical Control Cabinet	France Agro Ind.	France Agro Ind.		1
368B10	NC	Fish Hold – Cooling Coil 3000x1000	France Agro Ind.	France Agro Ind.		2
368BA11	NC	Fish Hold – Single Cooling Coil 2000x1000	France Agro Ind.	France Agro Ind.		2

Doc. Title	Ship Information Handbook		71 / 226
Doc. Reference	23,3 m Trawler		
Doc. Revision & Date	A - 15/09/14		

SHIP INDEX	EQUIP. INDEX	EQUIPMENT DESCRIPTION	MAKER	ORIGINAL SUPPLIER	MODEL / TYPE / DESIGNATION	NB OF UNITS
368B1 2	NC	Fish Hold – Double Cooling Coil 2000x1000	France Agro Ind.	France Agro Ind.		2
368B1 3	QV-0-200	Ice Generator	Geneglance	France Agro Ind.	F100M	1

**371-00 Accommodation, Wheelhouse & Technical Rooms**

SHIP INDEX	EQUIP. INDEX	EQUIPMENT DESCRIPTION	MAKER	ORIGINAL SUPPLIER	MODEL / TYPE / DESIGNATION	NB OF UNITS
371-01	NC	Seat	Atout Pique	Atout Pique	NAUTIC CLASSIC	1

**410-00 AC 400V - 50Hz Electrical Network**

410-01	EF-0-001	Main Electrical Switchboard	SA2EI	CMN	132-F-M01-E-410EE-10	1
410-02	EE-0-001	Distribution Panel AC230V Machinery Room	SA2EI	CMN	132-F-M01-E-440EE-10	1
410-03	EE-0-002	Distribution Frame AC230V Wheelhouse	SA2EI	CMN	132-F-E01-E-440EE-20	1
410-04	EE-0-003	Distribution Panel AC230V Workshop	SA2EI	CMN	132-F-E02-E-440EE-30	1
410-05		Converter AC230V/ DC24V		Technitronic	LAMBDA	1
410-06	EF-0-002	Shore Socket 90A	Marechal	Rexel	31 64 017 677 + 31 6A 053	1

**412-00 Generator Set AC400V - 50Hz**

412-01	ED-0-002	Generator Set - AC400V-50Hz - 47kva	Caterpillar	Enéria	C4.4 DINA	1
412-02	NC	Diesel Engine	Caterpillar	Enéria	C4.4	1
412-03	NC	Alternator AC400V-50Hz - 47kva	Leroy Somer	Enéria	LSAM 43.2 S35 C6/4	1
412-04	NC	Remote Start Engine Management System	Deep Sea Electronics	Enéria	Model 520	1
412-05	ED-0-110	Remote Control Panel	Caterpillar	Enéria	271-2727	1
412-06	ED-0-001	Brushless Alternator, PTO Driven – AC400V-50Hz 100kVA	Meccalte	Enéria	ECP34 1L/4	1

**420-00 DC 24V Electrical Network**

420-01	EB-0-001	Battery Charger - AC230V/DC24V 60A	Enag	Enag	SEEL010309 (CDS3-24V60A)	1
420-02	EB-0-002	GMDSS Power Supply Box	Enag	Enag	SEEL006715	1
420-03	EB-0-005	Gel Battery 12V 165Ah	Energie Mobile	Seimi	GEL12-165	2
420-04	EB-0-007	Distribution Frame DC24V Wheelhouse	SA2EI	CMN	132-F-E01-E-420EB-20	1
420-05	EB-0-003 EB-0-013	Battery Master Switch	Reya	Reya	EM196SM	2

Doc. Title	Ship Information Handbook		72 / 226
Doc. Reference	23,3 m Trawler		
Doc. Revision & Date	A - 15/09/14		



SHIP INDEX	EQUIP. INDEX	EQUIPMENT DESCRIPTION	MAKER	ORIGINAL SUPPLIER	MODEL / TYPE / DESIGNATION	NB OF UNITS
------------	--------------	-----------------------	-------	-------------------	----------------------------	-------------

**440-00 Lighting System**

440-01	ES-0-002	Converter 230VAC / 24VCC	Technitronic	Technitronic	DPP480-24-1	1
440-02	EE-0-108	External Lighting Panel	VDO	Kent Marine	AD241	1
440-03		Light Waterproof LED 2x18W 230V + LED 24V	Seimi	Seimi	FLED282202PE	43
440-04		Light Berth 230V 1x8W	Seimi	Seimi		8
440-05		Light Mirror 230V 15W	Seimi	Seimi	TL1458108SSC	2
440-06		Light Waterproof Recessed LED 230V 15W		Rexel	RTF8	11
440-07	EE-0-173 to EE-0-179	Floodlight 230V 750W	Seimi	Seimi	PPI1000	6
440-08	EE-0-182	Searchlight 230V 1000W	DHR	Seimi	210CS220CMN	1
440-10	EB-0-114	Chart Table LED 24V 20W	Seimi	Seimi	1210	1
440-11		Floodlight 230V 500W	Seimi	Seimi	PPI500	2
440-12		Downlight LED 24V 15W	Seimi	Seimi	01073	5
440-13	EB-0-129 EB-0-130 EB-0-131 EB-0-132 EB-0-135	Floodlight LED 24V 80W	Seimi	Seimi	01259	5
440-14	EB-0-134	Light Waterproof Recessed LED 230V 22W		Rexel	ITR400084	1

**448-00 Navigation Lights & Windscreen Wipers**

448-01	ES-0-001	Navigation Lights Monitoring & Control Panel	Marinelec	Marinelec	NORMA14CPDC	1
448-02	ES-0-003	Automatic Sound Signals Sequencer	Marinelec	Marinelec	CAPELLA V2	1
448-03	ES-0-016	Navigation Light - Masthead (White 225°)	DHR	Seimi	55VROUTE	1
448-04	ES-0-011	Navigation Light - Towed (Yellow 135°)	DHR	Seimi	55VRJ	1
448-05	ES-0-024	Navigation Light - Starboard (Green 112,5°)	DHR	Seimi	55VTD	1
448-06	ES-0-021	Navigation Light - Port (Red 112,5°)	DHR	Seimi	55VBD	1
448-07	ES-0-005	Navigation Light - Anchor (White 360°)	DHR	Seimi	55VTHBC	1
448-08	ES-0-010	Navigation Light - Stern (White 135°)	DHR	Seimi	55VPOUPE	1
448-09	ES-0-007	Navigation Light - Not Under Command (Red 360°)	DHR	Seimi	55VTHR	2
448-10	ES-0-008	Navigation Light - Fishing (Green 360°)	DHR	Seimi	55VHV	1
448-11	ES-0-009	Navigation Light - Fishing (White 360°)	DHR	Seimi	55VTHBC	1

Doc. Title	Ship Information Handbook		73 / 226
Doc. Reference	23,3 m Trawler		
Doc. Revision & Date	A - 15/09/14		

SHIP INDEX	EQUIP. INDEX	EQUIPMENT DESCRIPTION	MAKER	ORIGINAL SUPPLIER	MODEL / TYPE / DESIGNATION	NB OF UNITS
448-12	ES-0-004	Ship's Whistle - Pneumatic Compressor DC24V	Marco	Seimi	05403	1
448-13	ES-0-030 ES-0-031	Windscreen Wiper E-Motor Unit - DC24V - Wall Thickness 40 to 65mm - Adjustable Wiping Angle 50°	Nautic	Seimi	NAUTI2460	2
448-14	NC	Wiper Pantograph Arm - Lengt 500mm	Nautic	Seimi	BPNAUTI500	2
448-15	NC	Wiper Pantograph Arm - Lengt 500mm	Nautic	Seimi	REGNAUTI500	2
448-16	ES-0-040	Control Panel - Windscreen Wipers	Nautic	Seimi	CT42	1
448-17	ES-0-036	Windscreen Wipers E-Valve DC24V	Nautic	Seimi	EVA24	1
448-18	ES-0-039	Windscreen Wipers Switch	Nautic	Seimi		1

**470-00 Alarms & Safety**

470-01	MO-0-001	Bilge Alarm Panel	Marinelec	Marinelec	ALTAIR-16V2	1
470-02	MO-0-002	Bilge Alarm Acquisition Box	Marinelec	Marinelec	ALTOR-8-CAB	1
470-03	MO-0-003	General Alarm Panel	Marinelec	Marinelec	ALTOR-8-CA	1
470-04	EB-0-138	BRIDGE Navigational Watch Alarm Box	Marinelec	Marinelec	LYNX V3S	1
470-05	MO-0-010 to 014	Bilge Level Switch	Marinelec	Marinelec	DVES01SBV1	5
470-06	MO-0-008 MO-0-009	Siren & Flashlight	Marinelec	Marinelec	FLASHROUGE+SIRENEM	2
470-07	MO-0-007	Siren	Marinelec	Marinelec	SIRENE24VDC107DBBP	1
470-08	MO-0-004	Converter 230VAC / 24VCC		Technitronic		1
470-09	MO-0-015	Magnetic Flow Switch	Mobrey	Automatec	S195-D6BL-F93	10
470-10	MO-0-006	Pressure Switch				1

**541-00 Propulsion Plant**

541-01	NC	Main Propulsion Diesel Engine	Caterpillar	Enéria	C32 ACERT Phase 3	1
541B02	MD-0-001	Reduction Gear Box	Masson	Masson	MM-W-3900-NR-CEW	1
541B03	NC	Elastic Coupling (Shaft Generator)	Stromag	Masson		1

**543B00 Exhaust Plant - Trawler**

543B01	NC	Exhaust Pipes Assy, Main Engine	CMN	CMN		1
543B02	NC	Exhaust Muffler, Main Engine	SM25P	IAC Accoustics		1
543B03	NC	Exhaust Compensator DN250, Main Engine	Stenflex	Stenflex		1

Doc. Title	Ship Information Handbook		74 / 226
Doc. Reference	23,3 m Trawler		
Doc. Revision & Date	A - 15/09/14		

SHIP INDEX	EQUIP. INDEX	EQUIPMENT DESCRIPTION	MAKER	ORIGINAL SUPPLIER	MODEL / TYPE / DESIGNATION	NB OF UNITS
543B04	NC	Exhaust Pipes Assy, 1 x Genset	CMN	CMN		1
543B05	NC	Exhaust Muffler, Genset		Enéria		1
543B06	NC	Exhaust Compensator DN80, Genset	Stenflex	Stenflex		1

**572B00 Shafting Line and Fixed Pitch Propeller (FPP) - Trawler**

572B01	NC	Propeller Shaft	Masson	Masson	M12 0305	1
572B02	NC	Bulkhead Seal	Wärtsilä	Masson	Manesafe ND	1
572B03	NC	Shaft Coupling Assy	Masson	Masson	501781	1
572B04	NC	Propeller Shaft Earthing System	Technitronic	CMN	ADK1006150	1
572B05	NC	Transmission Lock	Masson	Masson	500343	1
572B06	NC	Propeller	Masson	Masson	MMS480 (501782)	1
572B07	NC	Stern Tube Assy	Masson	Masson	501775	1
572B08	NC	Aft Stern Tube Seals	Wärtsilä	Masson	OLS3-P	1
572B09	NC	Fwd Stern Tube Seals	Wärtsilä	Masson	OLS2-P	1
572B10	NC	Hydraulic Block of Pitch Control	Masson	Masson		1
572B11	NC	Main Hydraulic Pump PTO Gearbox Driven	Masson	Masson		1
572B12	NC	Stern Tube Lub Oil Tank	Masson	Masson	501765	1
572B13	NC	Fwd Shaft Seal Lub Oil Tank	Masson	Masson		1
572B14	NC	Pitch Feedback Repeater	Masson	Masson	500999	1
572B15	NC	Emergency Handpump	Masson	Masson	500291	1

**575-00 Sea Water Cooling System**

575-01	NC	Sea Water Strainer DN125		Aquiro	1283	2
575A02	MM-0-001	Sea Water Centrifugal Selfpriming E-Pump 22m <sup>3</sup> /h 20m	Ascue	SEMIM	CA-50/2A	1

**577B00 Propulsion & Gensets Remote Control & Monitoring Systems**

577B01	MO-0-110	Remote Control Panel, Genset	Caterpillar	Enéria		1
577B02	MO-0-100	Remote Control Panel, Main Engine	Caterpillar	Enéria		1
577B03	MO-0-101	Engine Control Panel	Caterpillar	Enéria	MECP-1	1
577B04	MO-0-102	Pitch Propeller Remote Control Panel – Fore Bridge	Barillec	Masson	MMAS1308CMN-2	1
577B05	MO-0-103	Pitch Propeller Control Switchboard	Barillec	Masson	MMAS1308CMN-1	1

Doc. Title	Ship Information Handbook		75 / 226
Doc. Reference	23,3 m Trawler		
Doc. Revision & Date	A - 15/09/14		

SHIP INDEX	EQUIP. INDEX	EQUIPMENT DESCRIPTION	MAKER	ORIGINAL SUPPLIER	MODEL / TYPE / DESIGNATION	NB OF UNITS
577B06		Pitch Propeller Control Panel – Aft Bridge	Barillec	Masson	MMAS1308CMN-3	1
577B07	MO-0-140	Pitch Feedback Potentiometer	Masson	Masson	500999	1
577B08	MO-0-150	Gearbox Clutching Remote Control Panel	Barillec	Masson		1
577B09	EB-0-010	AGM Battery 12V 320Ah	Energie Mobile	Seimi	AGM12-320	2
577B10	EB-0-011	AGM Battery 12V 110Ah	Energie Mobile	Seimi	AGM12-110	2
577B11	NC	Single Lever Mechanical Control Head	Kobelt	Seimi	2046 SPE	1
577B12	MO-0-104	Electronic Clutch Control Adaptor	Kobelt	Seimi	2046910	1

**610-00 Internal Communication System**

610-01	TI-0-010	Public Adress System - Central Unit	Vingtor	Marelec	ETB-5	1
610-02	TI-0-005	Amplified Batteryless Telephone system - Main Station	Vingtor	Marelec	VSP-211-L	1
610-03	TI-0-006	Amplified Batteryless Telephone system - Main Station	Vingtor	Marelec	VSP-223-L	1
610-04	TI-0-011 to 014	Public Adress System - Substation	Vingtor	Marelec	STB-1	4
610-05	TI-0-015	Public Adress System - Substation	Vingtor	Marelec	STB-2	1
610-06	TI-0-016	Public Adress System - Loudspeaker	Vingtor	Marelec	VML-1520	1
610-07	TI-0-008	Amplified Batteryless Telephone system - Connection Box	Vingtor	Marelec	CD-4	1
610-08	TI-0-007	Amplified Batteryless Telephone system - Flashing Light	AE&T	AE&T	EHS24	3
610-09	TI-0-009	Amplified Batteryless Telephone system - Headset	Vingtor	Marelec	VSP-36-PELP	1
610-10	TI-0-001 TI-0-002 TI-0-003 TI-0-004	Video Camera		Marelec	ST-CAMIR30S	4
610-11	TI-0-100	CCTV Screen Display	IM-MON	Marelec	IM-MON-07	1

**620-00 External Communication System**

620-01	NL-0-036	VHF/IMM Radiotelephone	Furuno	Marelec	FM8900S	1
620-02	NL-0-068	VHF/IMM Radiotelephone - Handset		Marelec	FM8900S-HANDSET	1
620-03	NL-0-051	VHF/IMM Radiotelephone - Loudspeaker	Furuno	Marelec	SEM-21Q	1
620-04	NL-0-037 NL-0-038	VHF/IMM Radiotelephone - Antenna	Jeaybeam	Marelec	MAT270/15	2
620-05	NL-0-026	VHF Marine Radiotelephone	Furuno	Marelec	FM4721	1
620-06	NL-0-071	VHF Marine Radiotelephone - Handset		Marelec	FM4721-HANDSET	1
620-07	NL-0-027	VHF Marine Radiotelephone - Antenna	Jeaybeam	Marelec	MAT270/15	1
620-08	NL-0-064	HF/MF BLU Radiotelephone	Furuno	Marelec	FS1575	1

Doc. Title	Ship Information Handbook		76 / 226
Doc. Reference	23,3 m Trawler		
Doc. Revision & Date	A - 15/09/14		

SHIP INDEX	EQUIP. INDEX	EQUIPMENT DESCRIPTION	MAKER	ORIGINAL SUPPLIER	MODEL / TYPE / DESIGNATION	NB OF UNITS
620-09	NL-0-025	HF/MF BLU Radiotelephone - Control Unit	Furuno	Marelec	FS1575-CU	
620-10	NL-0-028 NL-0-029	HF/MF BLU Radiotelephone - Antenna	Furuno	Marelec	7,25m	2
620-11	NL-0-065	HF/MF BLU Radiotelephone - Antenna Coupler	Furuno	Marelec	AT-1575	1
620-12	NL-0-063	HF/MF BLU Radiotelephone - Handset	Furuno	Marelec	FS1575-HANDSET	1
620-13	NL-0-052	MF/HF BLU Loudspeaker	Furuno	Marelec	SEM-21Q	1
620-14	NL-0-072	Navtex Receiver	Furuno	Marelec	NX-700DPROA	1
620-15	NL-0-045	Navtex Antenna	Furuno	Marelec	NX-700DPROA-ANTENNA	1
620-16	NL-0-024	Navtex Monitor	Furuno	Marelec	NX-700DPROA-MONITOR	1
620-17	NL-0-030	AIS Transponder Class A	Transas	Marelec	AIS M-3	1
620-18	NL-0-031	AIS GPS Antenna	Transas	Marelec	AIS M-3-ANTENNA	1
620-19	NL-0-032	AIS VHF Antenna	Jeaybeam	Marelec	MAT270/15	1
620-20	NC	VHF GMDSS Handheld Radiotelephone	Ocean Signal	Marelec	V100B	1
620-21	NC	EPIRB	Ocean Signal	Marelec	E100G/ARH100	2
620-22	NC	SART	Ocean Signal	Marelec	S100	1

**630-00 Navigation System**

630-01	NL-0-001	Echosounder - Color LCD	Simrad	Marelec	FCV-1150	1
630-02	NL-0-074	Echosounder, Fish Finding	Simrad	Marelec	ES70-38/200KHZ	1
630-03	NL-0-018	Transducer 38/200khz	Simrad	Marelec	ES70-38/200KHZ	1
630-04	NL-0-033	Transducer 200khz	Furuno	Marelec	200B8	1
630-05	NL-0-034	Transducer 50khz	Furuno	Marelec	50B-9B 1KW	1
630-07	NL-0-035	Transducer Bronze Speed	Furuno	Marelec	ST02MSB	1
630-08	NL-0-070	VHF Direction Finder	Taiyo	Marelec	TD-L1550A	1
630-09	NL-0-049	ADDF	Taiyo	Marelec	TD-L1550A-ADDF	1
630-10	NL-0-050	VHF/ADDF Antenna	Taiyo	Marelec	TD-L1550A-ANTENNA	1
630-11	NL-0-044	36Nm X Band Marine Radar Antenna	Furuno	Marelec	M1835-ANTENNA	1
630-12	NL-0-004	36Nm X Band Marine Radar Display	Furuno	Marelec	M1835-DISPLAY	1
630-13	NL-0-042	48Nm X Band Marine Radar Antenna	Furuno	Marelec	M1945-ANTENNA	1
630-14	NL-0-005	48Nm X Band Marine Radar Display	Furuno	Marelec	M1945-DISPLAY	1
630-15	NL-0-090	Satellite Compass - Monitor	Furuno	Marelec	SC-502	1
630-16	NL-0-016	Satellite Compass - Processor Unit	Furuno	Marelec	SC-501	1

Doc. Title	Ship Information Handbook		77 / 226
Doc. Reference	23,3 m Trawler		
Doc. Revision & Date	A - 15/09/14		

SHIP INDEX	EQUIP. INDEX	EQUIPMENT DESCRIPTION	MAKER	ORIGINAL SUPPLIER	MODEL / TYPE / DESIGNATION	NB OF UNITS
630-17	NL-0-073	Satellite Compass - GPS Antenna	Furuno	Marelec	SC-303	1
630-18	NL-0-002	GPS Display	Furuno	Marelec	GP-33	1
630-19	NL-0-043	GPS Antenna	Furuno	Marelec	GPA-017	1
630-20	NL-0-006	GPS Navigator	Furuno	Marelec	GP-33	1
630-21	NL-0-046	GPS Antenna	Furuno	Marelec	GPA-017	1
630-22	NC	Marine Software	Maxsea	Marelec	Pack Timezero Plot	1
630-23	NC	East Affrica Charts	Maxsea	Marelec	MM3-V42-P00	1
630-24	NL-0-007	ECDIS - Personal Computer	MC-Marine	Marelec	PC NISE 3140	1
630-25	NL-0-022	ECDIS - Monitor 22' 12V	Neovo	Marelec	22-12V	1
630-26	NL-0-076	Weather Station	Radio Ocean	Marelec	ROWINDHOB2000	1
630-27	NL-0-010	Wind Sensor	Radio Ocean	Marelec		1
630-28	NL-0-008 NL-0-009	Display, Remote	Furuno	Marelec	RD33	1
630-29	NL-0-012	Autopilot Calculator	Simrad	Marelec	AP70	1
630-30	NL-0-015	Autopilot Display		Marelec	AP70	
630-31	NL-0-013	Compass Mini-Gyro	Simrad	Marelec	RC42N	1
630-32	NL-0-003	Magnetic Compass	Autonautic Inst.	Marelec	CHEE77	1
630-33	NL-0-023	Rudder Angle Indicator	Simrad	Marelec	IS40	1
630-34	NL-0-062	Rudder Feed Back	Simrad	Marelec	RF300	1
630-35	NL-0-020 NL-0-021	NMEA 0183 Buffer	Actisence	Marelec	NBF-2	2
630-36	NL-0-060	VMS	CLS	Marelec	LEO	
630-37	NL-0-061	VMS Beacon	CLS	Marelec	LEO	1
630-38	NL-0-059	Power Supply DC24/24V	Alfatronic	Marelec	DDI-24-24-072	1
630-39	NL-0-017	Computer		Marelec	ES70	1
630-40	NL-0-069	Display 22' 220V	Neovo	Marelec	22-220V	1
630-41	NL-0-019	Software & East Africa Charts	Ixblue	Marelec	SEAXPERT/2D-3D/ CHARTS/PC	1
630-42	NL-0-011 NL-0-040 NL-0-041 NL-0-039 NL-0-066	Converter DC24V/DC12V	Alfatronic	Marelec	KC021	5
630-43	EB-0-006	Gel Battery 12V 90Ah	Energie Mobile	Seimi	GEL12-90	2
630-44	NC	SOLAS Radar Reflector	Navimo	Marelec	ECHO 230	1
630-45	EB-0-004	Battery Master Switch	Reya	Reya	EM196SM	1

Doc. Title	Ship Information Handbook		78 / 226
Doc. Reference	23,3 m Trawler		
Doc. Revision & Date	A - 15/09/14		

## 90000 Fishing Equipment - Trawler

SHIP INDEX	EQUIP. INDEX	EQUIPMENT DESCRIPTION	MAKER	ORIGINAL SUPPLIER	MODEL / TYPE / DESIGNATION	NB OF UNITS
900B01	QL-0-001	Oil Tank Equipped	Bopp	Bopp	BE 10691	1
900B02	NC	Hydraulic Pump 6H14 FOL32, PTO Driven	Poclain	Bopp	19651679	1
900B03	NC	Hydraulic System	Bopp	Bopp	BE 10676	2
900B04	EF-0-004	Electrical Control Box	Bopp	Bopp	BE 10774	1
900B05	NC	Deck Control Panel	Bopp	Bopp	BE 10704	1
900B06	NC	Warp Winch	Bopp	Bopp	TS 10-35-20-1B HYDRO	2
900B07	NC	Dual Net Drum on Gantry	Bopp	Bopp	2-2-ECH-35-AC-MF	1
900B08	NC	Single Net Drum on Gantry	Bopp	Bopp	1-1-ECH-35-AC-MF	1
900B09	NC	Single Net Drum on Deck	Bopp	Bopp	1-1-ECH-18-MF-AG	1
900B10	NC	Gilson Winch	Bopp	Bopp	TCH-18-MF-HYDRO	1
900B11	NC	Leading Block	Mecanor	Mecanor		1
900B12	NC	Cable Warp Block	CMN	CMN		1
900B13	NC	Warp Block 15 tons	Nantaise des poulies	Nantaise des poulies	PM60BB	2
900B14	NC	Warp Block 6 tons	Nantaise des poulies	Nantaise des poulies	PPR6	4
900B15	NC	Unloading Tank	Benne	Benne		1
900B16	NC	Fish Conveyor	Benne	Benne		1
900B17	EF-0-010	Conveyor Control Panel	Benne	Benne		1

Doc. Title	Ship Information Handbook		79 / 226
Doc. Reference	23,3 m Trawler		
Doc. Revision & Date	A - 15/09/14		

## CHAPTER 4 – SYSTEMS FUNCTIONAL DESCRIPTION

### 4-1. HULL CORROSION PROTECTION SYSTEM

Cathodic protection of the underwater hull is ensured by sacrificial zinc anodes bolted to the hull, to the propeller fixed nozzle and the rudder of the ship.

Cathodic protection of seawater circuits is provided by rod zinc anodes judiciously arranged.

### 4-2. ANCHORING AND MOORING SYSTEM

The anchoring and mooring equipment includes two anchors of 255kg stowed on fore bridge deck. The anchors are deployed using the warp winches and cable warp block.

### 4-3. STEERING SYSTEM

The Trawler is equipped with one rudder operated by a hydraulic steering gear.

Characteristics of steering gear:

- Nominal Torque : 1520 kg.m
- Design Torque : 1900 kg.m
- Rotation Angle : 35°
- Manœuvre Time with one Pump : 28 sec. Port/Stbd
- Manœuvre Time with two Pumps : 14 sec. Port/Stbd
- Manœuvre Time Auxiliary : 60 sec. Port/Stbd

The remote control, located in the bridge desk, includes the following equipment:

- One steering wheel
- One manual / automatic selector
- Two rudder angle indicators

A hand operated pump driven by a wooden wheel, can be used to operate the steering gear, from the steering gear room, in case of power failure.

The steering system is interfaced with auto-pilot.

Doc. Title	Ship Information Handbook		80 / 226
Doc. Reference	23,3 m Trawler		
Doc. Revision & Date	A - 15/09/14		



#### 4-4. HEATING, VENTILATION AND AIR CONDITIONING

The ship is equipped with a mechanical ventilation system and electrical heaters.  
 An air conditioning system is fitted in the crew accommodation and in the wheelhouse.  
 The galley is equipped with independent mechanical hood ventilation.  
 The engine room is mechanically ventilated with one 12000 m<sup>3</sup>/h capacity air.

#### 4-5. SEA WATER COOLING SYSTEM FOR HVAC & FISHING REFRIGERATION PLANT

The Sea Water Cooling System for HVAC & Fishing Refrigeration Plant includes:

- Two electro-pumps of 15 m<sup>3</sup>/h – 20 m for Fish Hold and Ice Generator Refrigerating Units
- One electro-pump of 1,2 m<sup>3</sup>/h for Crew Accomodations & Galley Air Conditionning Units
- One electro-pump of 1,2 m<sup>3</sup>/h for Wheelhouse and Captain Cabin Air Conditionning Unit

The cooling system takes the sea water in the engine room SW crossover.

#### 4-6. FRESH WATER SYSTEM

The fresh water for domestic use is stored in a structural tank of 3m<sup>3</sup> located in the store room.

The fresh water is supplied by a water pressure set of 2.5 m<sup>3</sup>/h – 25 m.

Hot water is provided from 2 instantaneous electric water heaters of 7 kW each.

The fresh water filling connection is located on upper deck at stbd mast foot.

Fresh water tank is fitted with level switch of low level alarm (30% tank capacity) that is monitored by the general alarm panel in wheelhouse.

Two vent lines connected to the top of tank allow the air vent with aseptic filter to the main deck level.

The technical fresh water for supplying the ice generator is stored in a structural tank of 12m<sup>3</sup> capacity located in the bow.

The technical fresh water filling connection is located on bridge deck.

The technical fresh water is supplied to the ice generator by a self-priming E-pump.

Doc. Title	Ship Information Handbook		81 / 226
Doc. Reference	23,3 m Trawler		
Doc. Revision & Date	A - 15/09/14		

## 4-7. FIREMAIN SYSTEM

The fire fighting and washing system includes:

- One electro-pump of 25 m<sup>3</sup>/h – 30 m (fire and deck washing purpose)
- One electro-pump of 2 m<sup>3</sup>/h - 25 m (sea water for toilet flushing)
- One hand pump for emergency (fwd deck)
- Three fire hydrants

The ship is fitted with a not pressurised firemain system.

The primary purpose of firemain system is to provide the supply of sea water throughout the ship by the main fire pump to:

- One fire hydrant in the aft bridge deck
- One fire hydrant and washunit in the Fwd deck
- One fire hydrant in the Workshop
- One deckwash unit and washunit in aft deck

In the event of trouble of the main fire E-pump, an emergency hand pump is to provide the supply of sea water to a fire hydrant in the Fwd deck.

A washing system maintained to 2,5 bar pressure by a sea water pump is to provide the sea water to the toilet unit.

## 4-8. BILGE SYSTEM

The system includes:

- Two electro-pumps 15 m<sup>3</sup>/h – 20 m
- One hand pump 2m<sup>3</sup>/h

The ship is fitted with three methods of extracting bilge water from the ship:

- One mud box directly connected to the bilge pumps allows the draining/dewatering of the engine room
- One suction manifold allows the selection of the compartment to be drained/dewatered
- One emergency draining/dewatering of the engine room by the sea water cooling pump of the main engine or by the fire pump through the sea water crossover

An oily water tank collects oily water from drip trays of the engine room and fuel oil separator.

An output connection located on main deck allows the drainage of tank.

The dewatering of forepeak is operated by handpump.

Doc. Title	Ship Information Handbook		82 / 226
Doc. Reference	23,3 m Trawler		
Doc. Revision & Date	A - 15/09/14		

## 4-9. SEWAGE AND SANITARY SYSTEM

Grey waters from galley sink, showers and hand-basins are drained overboard.

The toilet is flushed with sea water of the washing system.

Black waters from toilet are drained overboard.

## 4-10. FUEL TRANSFER OIL SYSTEM

The system includes:

- One centrifugal fuel separator
- One transfer electro pump of 10 m<sup>3</sup>/h – 20 m
- One transfer hand pump
- Five storage tanks
- One service tank
- One manifold allowing the transfer of the fuel from any storage tank to any other storage tank or to the service tank through the separator

The storage tanks and the service tank are equipped with a remote control quick closing valve from the CO2 room.

Filling by bunker station located at port on upper deck (max flow rate: 30m<sup>3</sup>/h) through the filter.

Discharge of fuel oil to shore by transfer pump.

Every fuel oil tank is equipped with a water draining suction pipe with self-closing valve operated from engine room.

The filling line overflow is discharged in the N°4 tank.

Via air vent and overflow system:

- The overflow of N°2 tank is discharged in the N°4 tank
- The overflow of N°1 and N°5 tanks are discharged in the N°3 tank

The fuel oil separator takes suction from any storage tank and discharges in the service tank.

The fuel oil separator takes suction from any storage tank and discharges in the service tank.

The main engine and the generating set supply lines are connected to the service tank and fitted with prefilters.

Fuel oil samples and water draining of fuel tanks is aided by connections and self closing valves.

Vent lines connected to the top of all tanks allow the air vent with flame arrester to the main deck level.

Fuel Oil capacities:

- Storage Tank N°1 (D T1) : 3,3m<sup>3</sup> (Stbd Storage Room)
- Storage Tank N°2 (D T2) : 3,3m<sup>3</sup> (Port Storage Room)
- Storage Tank N°3 (C T1) : 10m<sup>3</sup> (Stbd Engine Room)
- Storage & Overflow Tank N°4 (C T2) : 10m<sup>3</sup> (Port Engine Room)

Doc. Title	Ship Information Handbook		83 / 226
Doc. Reference	23,3 m Trawler		
Doc. Revision & Date	A - 15/09/14		

- Storage Tank N°5 (B T10) : 9,27m<sup>3</sup> (Fish Hold Room)
- Service Tank (C R2) : 1 m<sup>3</sup>

Storage fuel oil tanks (N°1), (N°2), (N°5) and fuel oil service tank are fitted with level switch and low level alarm (30% tank capacity) that is monitored by the general alarm panel.

Storage fuel oil tanks (N°3) and (N°4) are fitted with level switch, low level alarm (30% tank capacity) and very high level alarm (97% tank capacity) that is monitored by the general alarm panel.

Storage tanks located in storage and engine room are fitted with local sounding gauge.

Storage tank (N°5) located under the fish hold are fitted with a level glass gauge visible from engine room.

#### 4-11. LUBRICATING OIL TRANSFER SYSTEM

The lubricating oil system includes:

- One new oil filling station located at port on upper deck
- One new oil tank (C R1) capacity 0.7m<sup>3</sup>
- One polluted oil tank (C R3) capacity 0.3m<sup>3</sup>
- One polluted oil discharge hand pump 4.3m<sup>3</sup>/h
- One polluted oil discharge station located at port on upper deck

The lubricating oil is embarked by gravity to the new oil tank.

New oil is manually transferred to the main engine and gensets.

Polluted oil stored in the polluted oil tank is removed from the main engine and gensets by their own hand pumps.

Polluted oil is discharged to the shore facilities through a deck draining station located to the upper deck.

Vent lines connected to the top of tanks allow the air vent with flame arrester to the main deck level.

New and polluted oil tanks are fitted with a level glass gauge.

#### 4-12. REFRIGERATION PLANT FOR FISH HOLD AND ICE GENERATOR

The ship is equipped with a refrigeration plant:

- To maintain one fish hold of 90m<sup>3</sup> at 0°C
- To supply one ice generator

Doc. Title	Ship Information Handbook		84 / 226
Doc. Reference	23,3 m Trawler		
Doc. Revision & Date	A - 15/09/14		

The fish Hold 90m at 0°C refrigeration unit includes:

- One semi-hermetic reciprocating compressor of 6,9kW at -35°C / +36°C
- One sea water cooled condenser (sea water flow 4m<sup>3</sup>/h)
- Operating with R404A gas refrigerant
- Two copper coils of 3 m length at direct expansion
- Two copper coils of 2 m length at direct expansion
- Two double copper coils of 2 m length at direct expansion

The ice generator refrigeration unit includes:

- One semi-hermetic reciprocating compressor of 9,7kW at -45°C / +36°C
- One sea water cooled condenser (sea water flow 4m<sup>3</sup>/h)
- Operating with R404A gas refrigerant
- One ice generator of 2000 kg/day (with sea water temp. at 26°C)

#### 4-13. CO2 FIRE EXTINGUISHING SYSTEM

The engine room and workshop are protected by a CO2 inert gaz fixed.

The CO2 battery includes two bottles with capacity 50 litres charged with 33kg of CO2.

The CO2 battery is located in CO2 room at the main deck alleyway level.

CO2 discharge is activated locally by a mechanical release lever.

Volume of Rooms:

- Engine Room : 76m<sup>3</sup>
- Workshop : 13m<sup>3</sup>

#### 4-14. AC 400 V-3-50 Hz NETWORK

Electrical distribution is made through 3 networks:

- Main power network AC400V- 50Hz-3 phases
- Lighting, sockets and small auxiliaries network 230 VAC-50Hz-1 and 3 phases
- Direct current network 24VDC with batteries and battery chargers.

The main power network is AC400V–50 Hz–3 phases with neutral insulated and not distributed.

The electrical production is made by:

- One 100 kVA shaft generator driven by the PTO of the reduction gearbox of the propulsion plant (when the Trawler is sailing or fishing)

Doc. Title	Ship Information Handbook		85 / 226
Doc. Reference	23,3 m Trawler		
Doc. Revision & Date	A - 15/09/14		

- One 47 kVA generating set (when the Trawler is anchoring or alongside)
- One a shore supply connection (when the Trawler is alongside)

The shaft generator, the generating set and the shore connection are connected to the EF-0-001 main switchboard located in the engine room.

The shaft generator and the generating set are not electrically connectable.

To go from "Earth" mode to "Diesel Generator" mode or "Shaft Generator" mode, a blackout is mandatory.

The main switchboard is composed of one production cell and one distribution cell.

The main switchboard is equipped with switching, measuring, protection and monitoring units required for switching and monitoring the electrical system.

The distribution panel supplies the following equipment:

- Hydraulic Power Pack for Steering Gear
- Refrigerating Units for Fish Hold and ice generator
- Engine Room Ventilation Fans
- Fuel Oil Transfer Pump
- Hydraulic Power Pack for fishing winches and drums
- Water Heaters
- Fire pump
- Bilge pumps
- Electric Cooker
- Washing Pressure Pump (Toilet)
- Fresh Water Pressure Pump
- Fish conveyor

Outputs from the distribution panels are identified by labels and protected by circuit breakers calibrated in accordance to the consumer power requirement. All the metallic parts are connected to the ship's hull by way of an earth pole link (dedicated Green/Yellow conductor or braid).

#### 4-15. AC 400 V-3-50 Hz SHAFT GENERATOR

When the Trawler is sailing or fishing, the electrical power generation is accomplished by the three-phase AC synchronous constant voltage and brushless alternator named "Shaft Generator".

The shaft alternator is driven by the reduction gearbox of the propulsion plant.

The installation of the 100kVA shaft generator requires that the propulsion engine is constantly running at its rated speed.

Doc. Title	Ship Information Handbook		86 / 226
Doc. Reference	23,3 m Trawler		
Doc. Revision & Date	A - 15/09/14		

To power the network at 50Hz frequency, the shaft generator driven by the propulsion plant, must turn at the fixed regime of 1500rpm.

The shaft generator is driven by a constant PTO drive (ratio 1.0795 / 1) at 1500rpm corresponding to a nominal engine regime of 1619rpm.

Characteristics of main alternator:

- Brushless
- Double bearings
- 400 V – 3 – 50 Hz
- IP23
- Class H

#### 4-16. AC 400 V-3-50 Hz GENERATOR SET

At anchor or alongside, the electrical power generation is accomplished by one three-phase AC synchronous constant-voltage generators with an output of 42,7kW at 400V voltage and 50Hz frequency.

The generator is drove by a four-cylinder in-line, four-stroke diesel engine mounted on the same skid.

The starting of genset is performed by hand.

Characteristics of the diesel engine:

- Natural aspirated
- Displacement 4,4 litre
- Rotation Counterclockwise
- Sea water cooled
- Electric starter
- Starting battery
- DC24V Charging alternator

#### 4-17. AC 230 V-1-50 Hz LIGHTING NETWORK

The AC230V-50Hz lighting network is supplied by AC400V busbars and distributed from the main switchboard.

Each output is clearly identified and protected by way of a circuit breaker (differential protection for sockets).

Doc. Title	Ship Information Handbook		87 / 226
Doc. Reference	23,3 m Trawler		
Doc. Revision & Date	A - 15/09/14		

The network is distributed in two and three phases, with the earth pole connected to the Ship's hull.

All technical areas are lighted by fluorescent lights.

The fishing deck is lighted by two independent fluo light networks to achieve two levels of lighting and enhance the working conditions of the crew.

The aft part of the main deck located under the net drums is lighted with LED flood lights.

The wheelhouse and accommodation spaces are lighted by LED lights.

The exterior decks are fitted with LED lights.

One 24 VDC emergency lighting network is provided to light following areas in case of failure of the main power supply:

- Technical areas
- Accommodation spaces
- Alleyways

#### 4-18. DC24V NETWORK

The Trawler is provided with two independant DC24V networks:

- One general service network supplying navigation equipment, fire detection system, fire extinguishing system, internal communications, emergency lighting..., including:
  - One DC24V distribution panel
  - One battery charger AC230V-1-50Hz/DC24V 60A
  - Two 12V 165Ah gel batteries

In case of a failure of the main power network (AC100V-1-50Hz), the supply of the DC24V equipment is automatically switched on the corresponding battery.

- One GMDSS network supplying the VHF equipment, the BLU HF equipment and NAVTEX equipment, including:
  - One GMDSS Power Supply Box AC230V-1-50Hz/DC24V 30A
  - Two 12V 90Ah gel batteries (3 hours autonomy)

In addition to the two here above networks, the ship is equipped with:

- One 12V 320 Ah AGM batterie dedicated to the start of the main engine
- One 12V 110 Ah AGM batterie dedicated to the start of the genset

Doc. Title	Ship Information Handbook		88 / 226
Doc. Reference	23,3 m Trawler		
Doc. Revision & Date	A - 15/09/14		



#### 4-19. PROPULSION SYSTEM

The Trawler is provided with a propulsion plant composed of:

- One caterpillar C32 diesel engine (559 kW at 1600 rpm) Rating A
- One Masson MM3900 reduction gearbox (reduction ratio 6,82/1)
- One Masson controllable pitch propeller 1970 mm diameter (4 blades)
- One fixed nozzle

#### 4-20. MAIN PROPULSION ENGINE

The Caterpillar C32 marine diesel engine has the following characteristics:

- Nominal speed 1619 rpm
- Four-stroke cycle
- Twelve cylinders V block
- Direct fuel injection
- Twin turbocharged aftercooled aspiration
- Displacement 32 litre
- Rotation Counterclockwise
- Sea water cooled
- Electric starter
- Starting battery
- DC24V Charging alternator

#### 4-21. PROPELLER AND MARINE TRANSMISSION

The propeller and marine transmission of trawler is mainly composed of:

- One Masson reduction gear box
- One Masson controllable pitch propeller (CPP)
- One Masson stern tube and propeller shaft

Characteristics of the reduction gear box:

- Ratio output shaft : 6.82/1
- Ratio PTO of shaft generator : 1.0795/1
- Propeller rotation : clock wise
- Ratio PTO-Clutch of fishing gear HP pump : 0.883/1
- Ratio PTO of CPP HP pump : 1/1

Doc. Title	Ship Information Handbook		89 / 226
Doc. Reference	23,3 m Trawler		
Doc. Revision & Date	A - 15/09/14		

The CPP is composed of:

- One propeller shaft
- One bulkhead seal
- One earthing assembly
- One transmission lock
- One propeller 480 mm hub diameter
- One fixed nozzle
- One aft stern tube assembly
- One fore stern tube assembly
- One lubricating oil tank
- One electronic propeller control system

Characteristics of the propeller shaft:

- Length : 7128 mm
- Diameter : 162

Characteristics of the propeller:

- Diameter : 1970 mm
- Number of blades : 4
- Rotation : Clock Wise
- Nominal speed : 237 rpm
- Material : CU3
- Standard ISO : 484/2 Class 1
- Static balancing
- Inside diameter of propeller nozzle : 2000 mm

## 4-22. EXHAUST SYSTEM

The exhaust gases of the main engine and the generator set are ducted to the funnel.

The main engine and the generator are equipped with a dry exhaust system composed of:

- One steel compensator mounted on the engine
- One set of steel exhaust pipes
- One silencer

Doc. Title	Ship Information Handbook		90 / 226
Doc. Reference	23,3 m Trawler		
Doc. Revision & Date	A - 15/09/14		

#### 4-23. SEA WATER COOLING SYSTEM

The sea water cooling system is composed of:

- Two sea chests at engine room port and starboard side
- Two main sea water strainers
- One main manifold in engine room (crossover)

The following equipment takes sea water from the main manifold in the Engine Room:

- Main Engine Cooling
- Genset Cooling
- Refrigeration Plant for Fish Hold & Ice Generator Cooling
- Fire Fighting & Washing Pumps
- Emergency Fire Fighting Hand Pump
- Sea Water Cooling System for HVAC
- Sea Water cooling Pump for fishing gear

A bilge mud box is connected to the main manifold in order to allow in case of emergency the dewatering of the engine room by the sea water cooling pump of the main engine and by the fire pump.

#### 4-24. MONITORING AND REMOTE CONTROL SYSTEM

The monitoring and remote control, located in the fore bridge desk, include the following equipment:

- One engine remote control panel
- One single lever mechanical control head
- One pitch propeller bridge control panel
- One clutching panel

#### 4-25. INTERNAL COMMUNICATION SYSTEM

One intercom subsystem, Vingtor, is fitted with 5 terminals, providing the following functions:

- Point to point communication
- Intercommunication/conference
- General broadcast
- Alarms

Doc. Title	Ship Information Handbook		91 / 226
Doc. Reference	23,3 m Trawler		
Doc. Revision & Date	A - 15/09/14		

The main station is located in the wheelhouse.

The terminals are located in the following rooms:

- Engine room
- Steering gear room
- Crew quarters
- Mess
- Workshop

## 4-26. EXTERNAL COMMUNICATION SYSTEM

The GMDSS (Global Maritime Distress Safety System) covers navigation in A1+A2 area up to 100 nautical miles of the coast.

The GMDSS is compliant to the SOLAS convention.

It includes:

- One VHF/IMM FURUNO-FM8900S transceivers with associated digital selective call controller. This transceiver will be connected to the GPS, in order to transmit ship position in case of distress
- One MF FURUNO-FM1570 transceiver associated with an MF DSC controller (associated with two 7.25m long whip antennas)
- Two VHF Ocean Signal V100B watertight portable transceivers, GMDSS compliant
- One emergency Position Indication Radio Beacon (EPIRB) Ocean Signal E100G /ARH100 type
- One radar transponder (SART) FURUNO S100 type
- One Navtex FURUNO NX700 Prob with printer

GMDSS network is supplied by DC24V emergency supplies.

A reserve of energy will be provided to supply radio installations, for the purpose of conducting distress and safety radio communications, in the event of failure of the ship's main and emergency sources of electrical power.

One AIS transponder (Automatic Identification System), TRANSAS Class A type, is fitted.

## 4-27. NAVIGATION SYSTEM

The navigation equipment is compliant to the future SOLAS convention, applicable to fishing ships of less than 24m.

It includes:

- One integrated log/echo Sounder FURUNO FCV1150 type including:

Doc. Title	Ship Information Handbook		92 / 226
Doc. Reference	23,3 m Trawler		
Doc. Revision & Date	A - 15/09/14		

- One central unit with integrated control panel
- One flush mounted hull sensor
- Two GPS FURUNO GP 33 type. The 4.3 inches control panel is integrated to wheelhouse console
- The secondary GPS allows securing GPS function
- One magnetic compass fitted in the wheelhouse
- One X Band Radar (36Nm) FURUNO M1835 type used as main radar on the ship or as a secondary one

Radar characteristics:

- Maximum detection range : 36 Nautical Miles
- Power : 4 kw
- Antenna : 24 inches
- Screen : 10 inches
- One X Band Radar (48Nm) FURUNO M1945 type used as main radar on the ship or as a secondary one

Radar characteristics:

- Maximum detection range : 48 Nautical Miles
- Power : 4 kw
- Antenna : 40 inches
- Screen : 10 inches
- One FURUNO SC-30 type satellite compass allows displaying ship heading true or magnetic and GPS data, and to distribute this information to others subsystems (Auto pilot, radar, ECDIS and Echo sounder)

Satellite Compass characteristics:

- Heading accuracy : 0,5°
- Heading Resolution : 0,1°
- Follow up rate : 45°/s
- One ECDIS (nautical charts)

This system allows displaying Nautical charts on PC screen.

It is based on Max sea Time zero Pro software.

This software manages and display following data:

- Ship GPS Positioning
- Weather Forecast
- Tidal current
- Waypoint and routes

Doc. Title	Ship Information Handbook		93 / 226
Doc. Reference	23,3 m Trawler		
Doc. Revision & Date	A - 15/09/14		

More over, a module allows recording one echo sounding point per second (through a connection between GPS and echo sounder) and created an accurate 3D chart of the ocean floor.

All the tracks, marking can be recorded, as well in 2D or 3D mode.

One weather station RADIO OCEAN Rowind 33 including:

- One static sensor allowing measurement of the following parameters:
  - Relative speed and true wind
  - Wind direction
  - Air temperature
  - One display on the wheelhouse
- One video system CCTV 4 video cameras
- A main station in the wheelhouse is connected to 4 video cameras, in order to enhance safety on board
- One VHF radio receiver direction finder TAIYO TDL1550 A type able to detect Radio transmission from ships or coastal station
- The direction of the transmission and its level is displayed
- The system is able to scan VHF channels, 16 channel and aero distress 121.5 frequency
- One Autopilot SIMRAD AP70 type, including a gyro compass RC 25 type  
The autopilot is interfaced with the steering gear.  
It is connected to a rudder angle indicator SIMRAD RI35 (45° Starboard, 45° portside).
- One IXBlue system Multibeam sounder, data base

This system is based around a WASSP Multi beam sounder, allowing carrying out a very powerful probe on 120° under the ship.

Associated with dedicated software, it can reconstitute a 3D display of the ocean floor and the fishing resources.

A data base of the catches, according to geographical position of the ship and sounder data can be managed.

The 3D display allows a particularly effective work on wreck.

Information available allows a reduction in the fuel oil costs and a better resources management.

## 4-28. FISHING GEAR

The Trawler is equipped with the following fishing equipment:

- Two warp winches
  - Rope capacity : 1000 m of trawling warp Ø 20 mm

Doc. Title	Ship Information Handbook		94 / 226
Doc. Reference	23,3 m Trawler		
Doc. Revision & Date	A - 15/09/14		

- Automatic synchronized rope-coiling trolley
  - Hydraulic and manual claw clutch and brake
  - Pull capacity at middle layer : 5000 daN
- One single and one double net drums, fitted on stern gantry
    - Capacity : 3 x 4,8 m<sup>3</sup>
    - Drum shaft diameter : 292 mm
    - External diameter : 2200 mm
    - Width : 1350 mm
    - Pull capacity at drum shaft (max) : 12000 daN
- One storage drum (located on bridge aft deck at portside)
    - Capacity : 2,9 m<sup>3</sup>
    - Drum shaft diameter : 240 mm
    - External diameter : 1800 mm
    - Width : 1200 mm
    - Pull capacity at drum shaft (max) : 8900 daN
- One Gilson winch fitted on aft shelter deck
    - Rope capacity : 40 m of hauling warp Ø 20 mm
    - Drum shaft diameter : 73 mm
    - External diameter : 700 mm
    - Width : 180 mm
    - Hydraulic brake
    - Pull capacity at drum shaft : 6400 daN

Winches and drums are driven by a hydraulic system including the main following equipment:

- One hydraulic pump with 6 independent flows fitted on a clutchable PTO of the gear box
- One hydraulic 700 liters tank with filtration and oil cooler
- One electrical control box
- One deck control panel

## 4-29. FISH TREATMENT

The Trawler is equipped with an unloading tray to receive the content of the cod end.

The fish is the directed by a belt conveyor to three workstations to place the fish in storage boxes.

Doc. Title	Ship Information Handbook		95 / 226
Doc. Reference	23,3 m Trawler		
Doc. Revision & Date	A - 15/09/14		

## CHAPTER 5 – OPERATING INSTRUCTIONS

### 5-1 GENERAL INFORMATION

This chapter details the operating procedures applicable to this 23,3m Trawler.

The pre-operational checks and required procedures to make the Trawler ready for operation are described in the check list in order to assure that all preparatory procedures are completed.

The main requirements for placing each major equipment in operation and for shutting down or securing are also outlined.

Reference to onboard Maker's and Supplier's technical manuals is given when applicable.

### 5-2. PRE-OPERATIONAL CHECKLIST

The following pre-operational checks should be performed prior to operation of the Trawler in order to verify that the ship is seaworthy.

#### 5-2-1. Lifesaving Equipment

CHECK	REQUIREMENT
Verify the life saving and safety equipment are installed and operational.	- Lifebuoys and floating lines (2), - Light marker (1).
Ensure the presence of two liferafts. Ensure that the hydrostatic releases are correctly installed. Check the specified expiry date of hydrostatic releases.	Ensure the containers are stored correctly on to its cradles.
Ensure the presence of portable lifesaving equipment.	- Life-throwing apparatus (4) wheelhouse, - Life Jackets (2) wheelhouse, (2) workshop, (8) under each berth, - Red distress flares (6) wheelhouse, - Self-activating buoyant smoke signal (2) wheelhouse, - Portable signalling lamp (1) wheelhouse.
Ensure the presence and operating of following portable communication equipment. Check the specified expiry date of batteries.	- VHF portable GMDSS, - EPIRB

Doc. Title	Ship Information Handbook		96 / 226
Doc. Reference	23,3 m Trawler		
Doc. Revision & Date	A - 15/09/14		



**5-2-2. Firefighting Equipment**

CHECK	REQUIREMENT
Verify that sea water firemain system is operational.	
Verify that the CO2 firefighting system is operational.	As per outline in Tyco Operation and Maintenance Manual.
Ensure the presence of portable firefighting equipment.	- Water Spray Extinguishers (3), - CO2 Extinguishers (2), - Fire hose and nozzles (4), - Supply Air Breather (1).
Verify that fire detection system is operational	As per outline in Marinelec DI-09 Operation and Maintenance Manual.

**5-2-3. Machinery Equipment****Fuel Oil System**

CHECK	REQUIREMENT
Drain sludge and decantation water from the five Fuel Oil Storage Tanks and Service Tank.	Empty sludges and condensate water in the Oily Water Tank.
Check fuel level in storage Fuel Oil Tanks. Fill as necessary for mission. Tank capacities: Storage Tank 1 (Stbd Storage Room) : 3.300 litre Storage Tank 2 (Port Storage Room) : 3.300 litre Storage / Overflow Tank 3 (Stbd Engine Room) : 10.000 litre Storage / Overflow Tank 4 (Port Engine Room) : 10.000 litre Storage Tank 5 (Fish Hold Room) : 9.270 litre	Know the capacity of your fuel tanks and be aware of how much spare capacity. Be able to reconcile the quantity of fuel that goes in with the capacity of the tank. Fill as required with MARINE DIESEL FUEL OIL ONLY as indicated by fuel level indications located in the wheelhouse. The filling line overflows are discharged in the N°3 and N°4 tanks. Before refuelling, ensure that you have the correct fire-fighting equipment on board, that it is in good working order, that it is easily accessible and that you know how to use it. Make sure you know where is stored the hydrocarbon spill kit.
Verify that all Fuel Oil System valves are correctly positioned.	In accordance with § 5-3-7.
Test Quick Closing Remote Control Valves and release all tank valves in OPEN position. Check oil level for each independant remote control handle.	Remote Control System is located on the Main Deck Alleyway. Maintain the oil level to the full mark on the sight glass. Use ONLY designated HYDRAULIC OIL in respect to Lubricants Schedule.
Select the Storage Tank for supply the fuel oil separator and open the corresponding suction valve.	

Doc. Title	Ship Information Handbook		97 / 226
Doc. Reference	23,3 m Trawler		
Doc. Revision & Date	A - 15/09/14		

**Lubricating Oil System**

CHECK	REQUIREMENT
Check oil level in storage Tank.	As required, complete tank with Rimula R4L 15W-40 oil ONLY, in respect to Lubricants Schedule. Know the capacity of your oil tank and be aware of the reserve capacity.

**Sea Water Cooling System (Main propulsion engine and Genset)**

CHECK	REQUIREMENT
Remove and clean the sea chest strainer, clean thoroughly body and basket and reinstall.	Working on each strainer one after another. Isolate the filter (close inlet and outlet valves) and drain internal pressure before removing the cover.
Operate all valves and ensure that they are correctly positioned.	In accordance with § 5-3-18.

**Shafting Line and Controllable Pitch Propeller**

CHECK	REQUIREMENT
Check lubricating oil level of: - Stern tube oil tank located in workshop, - Fwd shaft seal oil tank located in storage room. Add lub. oil as required.	Maintain the oil level to the full mark on the level indicator or dipstick. Use ONLY designated LUBRICATING OIL in respect to Lubricants Schedule.
Check the stern tube area for leaks and free rotation of shaft.	
Check the area of shaft coupling and pitch indicator for: - ensure that the free rotation of shaft (presence of rags or other), - ensure that the earthing brushes are not loose or corroded.	
The hydraulic system is fed from the gearbox sump. Please refer to the hereafter "Main propulsion system" for the oil level check.	

**Main Propulsion System (Main Engine & Reduction Gearbox)**

CHECK	REQUIREMENT
Ensure that main propulsion engine and reduction gearbox are free of all maintenance operations.	
Check oil level of main propulsion engine with dipstick. Add lubricating oil as required.	Maintain the oil level to the full mark on the level gauge. Use ONLY designated LUBRICATING OIL in respect to Lubricants Schedule.
Check oil level of gearbox with dipstick ENGINE RUNNING AT IDLE. Add lubricating oil as required.	Maintain the oil level to the full mark on the level gauge. Use ONLY designated LUBRICATING OIL in respect to Lubricants Schedule.
Check Coolant level of main propulsion engine.	Maintain the coolant level to the full mark on the tank. Use ONLY designated COOLANT in respect to Lubricants Schedule.

Doc. Title	Ship Information Handbook		98 / 226
Doc. Reference	23,3 m Trawler		
Doc. Revision & Date	A - 15/09/14		

CHECK	REQUIREMENT
Verify starting DC24V power is available.	
Inspect the alternator belt on main engine.	Remove the belt guard if necessary.
Make sure the gearbox selector is in NEUTRAL position.	
Perform main propulsion engine pre-operational checks, to include alarms.	As per outline in Caterpillar C32 Operation and Maintenance Manual.

#### Generator Set

CHECK	REQUIREMENT
Ensure that the genset are free of all maintenance operations.	
Check oil level of Genset engine with dipstick. Add lubricating oil as required.	Maintain the oil level to the full mark on the level gauge. Use ONLY designated LUBRICATING OIL in respect to Lubricants Schedule.
Check Coolant level in the coolant expansion tank of engine.	Maintain the coolant level to the full mark on the tank. Use ONLY designated COOLANT in respect to Lubricants Schedule.
Verify starting DC24V power is available.	
Perform genset engine pre-operational checks, to include alarms.	As per outline in Caterpillar C4.4 Operation and Maintenance Manual.

#### Fishing Equipment - Hydraulic Power Pack

CHECK	REQUIREMENT
Ensure that all drums, winches and HPU are free of all maintenance operations.	
Check oil Tank level. Add hydraulic oil as required.	Maintain the oil level to the full mark on the level indicator. Use ONLY designated HYDRAULIC OIL in respect to Lubricants Schedule.

Doc. Title	Ship Information Handbook		99 / 226
Doc. Reference	23,3 m Trawler		
Doc. Revision & Date	A - 15/09/14		

**5-2-4. Auxiliary Equipment****Steering Gear**

CHECK	REQUIREMENT
Check oil Tank level. Add hydraulic oil as required.	Maintain the oil level to the full mark on the sight glass. Use ONLY designated HYDRAULIC OIL in respect to Lubricants Schedule.
Ensure that the rudder stock and jacks are free of movement.	
Verify that the steering system is operational.	As per outline in Fluidmechanica Operation and Maintenance Manual.

**Sea Water Cooling System for HVAC & Fishing Refrigeration Plant**

CHECK	REQUIREMENT
Operate all valves and ensure that they are correctly positioned.	In accordance with § 5-3-2.

**Fresh Water System**

CHECK	REQUIREMENT
Check the residual Fresh Water tank level (3000 litre capacity). Check the residual technical fresh water tank level (12000 litre capacity). Fill as necessary for mission.	Fill tanks using designated POTABLE WATER ONLY until tanks overflow.
Verify that the water heaters are operational.	

**Firemain System**

CHECK	REQUIREMENT
Operate all valves and ensure that they are correctly positioned.	In accordance with § 5-3-4.

**Bilge System**

CHECK	REQUIREMENT
Verify that bilge system is operational.	In accordance with § 5-3-5.

**Refrigeration Plant for Fish Hold and Ice Generator**

CHECK	REQUIREMENT
Check oil levels of reciprocating compressors.	If the oil level drops; seek skilled refrigeration personnel. Use ONLY designated LUBRICATING OIL in respect to Lubricants Schedule.
Check view finder indicator on liquid line.	Green: The refrigerant is dry. Yellow: the refrigerant is too wet; call skilled refrigeration personnel.
Check the level of salt tablets in the vertical doser tube of ice generator	

Doc. Title	Ship Information Handbook		100 / 226
Doc. Reference	23,3 m Trawler		
Doc. Revision & Date	A - 15/09/14		

**5-2-5. Electrical**

CHECK	REQUIREMENT
Ensure that all navigation lights are operational.	
Verify all searchlights are operational.	Test each light individually.
Verify the navigational horn is operational.	

**5-2-6. Communications - Navigation**

CHECK	REQUIREMENT
Ensure that all electronic equipment is operational.	

**5-2-7. Other**

CHECK	REQUIREMENT
Verify items stored in various storerooms and storage areas are secured for sea.	Check each storeroom and storage area. Secure items as required.
Verify the watertight hatch covers and watertight doors are closed and dogged tightly and all weathertight doors operate freely.	Check each hatch and door individually. Close and dog tightly as required.

**5-3. OPERATING OF THE SYSTEMS****5-3-1. Steering Gear****5-3-1-1. Monitoring and Control System**

The monitoring and control system includes in steering room:

- One rudder Angle Transmitter
- One emergency Hand Wheel
- One electrical starter PUMP 2
- One electrical starter PUMP 1

and in wheelhouse:

- Two rudder Angle Indicator
- One "AUTO/MANUAL" Selector
- One bridge Remote Control Monitoring and Alarm Panel
- One steering Wheel

The starting of hydraulic plant (Pump 1 & Pump 2) can be started locally or remotely.

The Bridge Remote Control Monitoring and Alarm Panel enable the operator to control the starting of one or two hydraulic pumps.

Moreover, if one power pack (Pump 1) is in standby position, any failure in the other power pack (Pump 2) involves the automatic starting of the power pack (Pump 1).

Doc. Title	Ship Information Handbook		101 / 226
Doc. Reference	23,3 m Trawler		
Doc. Revision & Date	A - 15/09/14		

An Emergency Hand operated pump driven by a wood wheel allows to control the locally steering gear .

One "AUTO/MANUAL" Selector allows the manual steering by the wheel or by the autopilot signals (AUTO Mode).

**5-3-1-2. Starting of Hydraulic Power Pack**

The ship is considered electrically self powered.

Before starting, ensure that pre-operational checks on the power pack are performed; mainly for oil level.

Do not start any engine if there is a warning tag attached to the starter panels.



Fig5-1 Steering Gear - Electrical Starters HPU1 & 2



Fig5-2 Bridge - Steering Gear Remote Control Monitoring and Alarm Panel



Figure 5-3 Bridge - Steering Wheel



Figure 5-4 Bridge - Auto-Manual Steering Selector

Doc. Title	Ship Information Handbook		102 / 226
Doc. Reference	23,3 m Trawler		
Doc. Revision & Date	A - 15/09/14		

**Starting Power Pack from Wheelhouse**

- Electrical starters (Steering Room)
    - Turn the selectors of "PUMP 1" and "PUMP 2" on the "REMOTE" position.
  - Bridge Remote Control Monitoring and Alarm Panel
    - Turn the selector of "PUMP 1" on the "ON" position and the selector of "PUMP 2" on the "STANDBY" position (or inversely).
- => The Pump 1 starts.  
=> In case of any failure of Pump 1, the Pump 2 starts automatically.

**Starting Power Pack from Steering Room**

- Electrical starters (Steering Room)
  - Turn the selector of "PUMP 1" on the "ON" position and the selector of "PUMP 2" on the "0" position (or inversely).

**5-3-1-3. Stopping of Hydraulic Power Pack**

Depending on where was made the start, set the switch to "0" or "OFF".

**5-3-1-4. Selection of steering mode (Main Bridge Desk)**

Turn the Steering Gear "AUTO/MANUAL" selector to the "AUTO" position for automatic steering by Autopilot.

**5-3-2. Sea Water Cooling System for HVAC & Fishing Refrigeration Plant**

The following table shows the valves position to be set to operate the sea water cooling system when the ship is in normal operation and no firefighting is operated:

VALVE N°	VALVE DESCRIPTION	VALVE LOCATION	VALVE POSITION
SR-0-501	Captain Cabin & Wheelhouse AC Condenser - Inlet	Wheelhouse	OPEN
SR-0-502	Galley AC Condenser - Inlet	Galley	OPEN
SR-0-507	Accommodations AC Condensers - Overboard Discharge	Port Engine Room	OPEN
SR-0-508	Fish Hold & Ice Generator Refrigerating Condensers - Sea Water Suction	Stbd Engine Room	OPEN
SR-0-509	Fish Hold Refrigerating Sea Water Pump SR-0-001 - Suction	Stbd Engine Room	OPEN
SR-0-510	Fish Hold Refrigerating Sea Water Pump SR-0-002 - Suction	Stbd Engine Room	OPEN
SR-0-511	Wheelhouse AC Condenser Sea Water Pump SR-0-003 - Suction	Stbd Engine Room	OPEN
SR-0-514	Galley & Crew Cabin AC Condenser Sea Water Pump SR-0-004 - Suction	Stbd Engine Room	OPEN
SR-0-515	Galley & Crew Cabin AC Condenser Sea Water Pump SR-0-004 - Discharge	Stbd Engine Room	OPEN
SR-0-516	Wheelhouse AC Condenser Sea Water Pump SR-0-003 - Discharge	Stbd Engine Room	OPEN
SR-0-517	Fish Hold Refrigerating Sea Water Pump SR-0-002 - Discharge	Stbd Engine Room	OPEN
SR-0-518	Fish Hold Refrigerating Sea Water Pump SR-0-001 - Discharge	Stbd Engine Room	OPEN
SR-0-521	Fish Hold Refrigerating Condenser - Inlet	Stbd Storage Room	OPEN
SR-0-522	Fish Hold Refrigerating Condenser - Discharge	Stbd Storage Room	OPEN
SR-0-523	Ice Generator Refrigerating Condenser - Inlet	Stbd Storage Room	OPEN
SR-0-524	Ice Generator Refrigerating Condenser - Discharge	Stbd Storage Room	OPEN
SR-0-527	Fish Hold & Ice Generator Refrigerating Condensers - Overboard Discharge	Port Storage Room	OPEN
SR-0-530	Crew Cabin AC Condenser - Inlet	Crew Cabin	OPEN
SR-0-531	Accommodations AC Condensers - Sea Water Suction	Stbd Engine Room	OPEN

Doc. Title	Ship Information Handbook		103 / 226
Doc. Reference	23,3 m Trawler		
Doc. Revision & Date	A - 15/09/14		

Close the circuit breaker D31 in the Main Switchboard EF-0-001 to supply the AC cooling pumps.

The starting and stopping of SW pumps are operated automatically by the air conditioning system.



Figure 5-5 Stbd Engine Room - SW AC Cooling Pumps

### 5-3-3. Fresh Water System

The following table shows the valves position to be set to operate the fresh water system when the ship is in normal operation and no fresh water replenishment is to be operated:

VALVE N°	VALVE DESCRIPTION	VALVE LOCATION	VALVE POSITION
SD-0-501	Technical Fresh Water Tank Filling - Outlet Filter	Fwd Storage Room	OPEN
SD-0-502	Ice Generator - FW Supply	Fwd Storage Room	OPEN
SD-0-503	Freshwater Storage Tank - Suction	Aft Engine Room	OPEN
SD-0-504	Fresh Water Filter - Inlet	Stbd Engine Room	OPEN
SD-0-507	Fresh Water Filter - Outlet	Stbd Engine Room	OPEN
SD-0-508	Sample Tanking Cock	Aft Engine Room	SHUT
SD-0-509	Fresh Water Pressure Pump - Discharge	Stbd Engine Room	OPEN
SD-0-511	Crew Sanitary Water Heater - Cold FW Supply	Crew Sanitary	OPEN
SD-0-512	Fuel Oil Separator - Fresh Water Supply	Port Engine Room	OPEN
SD-0-514	Fresh Water Tank Filling	Aft Engine Room	SHUT
SD-0-515	Crew Sanitary Water Heater - Hot FW Discharge	Crew Sanitary	OPEN
SD-0-517	Fresh Water Tank Filling - Outlet Filter	Aft Engine Room	OPEN
SD-0-518	Galley & Captain Cabin Water Heater - Cold FW Supply	Galley	OPEN
SD-0-520	Galley & Captain Cabin Water Heater - Hot FW Discharge	Galley	OPEN
SD-0-522	Technical Fresh Water Tank Filling - Outlet Filter	Fwd Storage Room	SHUT
SD-0-524	Ice Generator Water tank - Discharge	Fwd Storage Room	OPEN

Doc. Title	Ship Information Handbook		104 / 226
Doc. Reference	23,3 m Trawler		
Doc. Revision & Date	A - 15/09/14		



**5-3-3-1. Fresh Water Filling from Shore**

To replenish fresh water tank from the Deck connection (Stbd Side) it is necessary to operate the valves as indicated in the table below:

VALVE N°	VALVE DESCRIPTION	VALVE LOCATION	VALVE POSITION
SD-0-514	Fresh Water Tank Filling	Aft Engine Room	OPEN
SD-0-517	Fresh Water Tank Filling - Outlet Filter	Aft Engine Room	OPEN

**5-3-3-2. Technical Fresh Water Filling from Shore**

To replenish technical fresh water tank feeding the ice generator from the Deck connection (Fwd Bridge Deck) it is necessary to operate the valves as indicated in the table below:

VALVE N°	VALVE DESCRIPTION	VALVE LOCATION	VALVE POSITION
SD-0-501	Technical Fresh Water Tank Filling - Outlet Filter	Fwd Storage Room	OPEN
SD-0-522	Technical Fresh Water Tank Filling - Outlet Filter	Fwd Storage Room	OPEN



Figure 5-6 Engine Room - FW Pressure Pump



Figure 5-7 Fishing Deck - Aseptic Filter

**5-3-3-3. Operating of fresh water pressure pump**

Close the circuit breaker D17 in the main switchboard EF-0-001 to support the FW pump. The starting and stopping of FW pressure pump are operated automatically by the pressure of fresh water system.

**5-3-3-4. Operating of water heaters**

Close the circuit breakers D10 and D11 in the Main Switchboard EF-0-001.

Doc. Title	Ship Information Handbook		105 / 226
Doc. Reference	23,3 m Trawler		
Doc. Revision & Date	A - 15/09/14		

### 5-3-3-5. Operating of self-priming feeding pump

The self-priming pump of fresh water, feeding the ice generator, is started along with the ice generator.

### 5-3-4. Firemain System

The following table shows the valves position to be set to operate the firemain system when the ship and machinery equipment are in normal operation and no firefighting is to be operated:

VALVE N°	VALVE DESCRIPTION	VALVE LOCATION	VALVE POSITION
SM-0-501	Fire Hydrant - Upper Deck	Bridge Deck	SHUT
SM-0-502	Fishing Deck Wash - SW Supply	Aft Fishing Deck	SHUT
SM-0-503	Tray Crustaceans - SW Supply	Aft Fishing Deck	SHUT
SM-0-504	Tray Crustaceans - Drainage	Aft Fishing Deck	SHUT
SM-0-505	Washunit - SW Supply	Aft Fishing Deck	SHUT
SM-0-506	Fire Hydrant - Workshop	Workshop	SHUT
SM-0-507	Fire Hydrant - Fore Deck	Fwd Fishing Deck	SHUT
SM-0-508	Gravity Toilet - Isolating Valve	Crew Sanitary	OPEN
SM-0-509	Emergency Fire Hand Pump - Isolating Valve	Fwd Fishing Deck	SHUT
SM-0-510	Emergency Fire Hydrant - Fore Deck	Fwd Fishing Deck	SHUT
SM-0-514	Main Fire Pump - Discharge	Stbd Engine Room	OPEN
SM-0-515	Main Fire Pump - SW Suction	Stbd Engine Room	OPEN
SM-0-517	Sea Water Pressure Pump - Discharge	Stbd Engine Room	OPEN
SM-0-518	Sea Water Pressure Pump - SW Suction	Stbd Engine Room	OPEN
SM-0-520	Emergency Fire Hand Pump - SW Suction	Fwd Engine Room	OPEN



Figure 5-8 Engine Room - Fire Pump



Figure 5-9 Engine Room - Sea Water Pressure Pump

Doc. Title	Ship Information Handbook		106 / 226
Doc. Reference	23,3 m Trawler		
Doc. Revision & Date	A - 15/09/14		



Figure 5-10 Main Switchboard  
- Fire Pump Control



Figure 5-11 Workshop - Fire Pump  
Remote Control Panel

#### **5-3-4-1. Operating of sea water pressure pump**

Close the circuit breaker D16 in the Main Switchboard EF-0-001.

The starting and stopping of SW pressure pump are operated automatically by the pressure of sea water flushing system.

#### **5-3-4-2. Operating of fire pump from main switchboard EF-0-001 or from the Remote Control Box located in workshop**

Close the circuit breaker D12 in the Main Switchboard EF-0-001.

Press the green push-button to start the pump.

Press the red push-button to stop the pump normally.

In the event of any problem, press the "Emergency stop button" to stop and lock the Fire pump.

The Fire pump will not re-start when the button is locked. To unlock, turn the button clockwise in order to reset.

#### **5-3-5. Bilge System**

The following table shows the valves position to be set to operate the bilge system when the ship and machinery equipment are in normal operation and no bilge draining is to be operated:

Doc. Title	Ship Information Handbook		107 / 226
Doc. Reference	23,3 m Trawler		
Doc. Revision & Date	A - 15/09/14		

VALVE N°	VALVE DESCRIPTION	VALVE LOCATION	VALVE POSITION
SE-0-501	Bilge Pumps - Overboard Discharge	Port Engine Room	OPEN
SE-0-502	Bilge Pump SE-0-001 - Discharge	Stbd Engine Room	OPEN
SE-0-503	Bilge Pump SE-0-002 - Discharge	Stbd Engine Room	OPEN
SE-0-505	Bilge Pump SE-0-001 - Suction	Stbd Engine Room	OPEN
SE-0-507	Bilge Pump SE-0-002 - Suction	Stbd Engine Room	OPEN
SE-0-509	Fwd Engine Room - Bilge draining	Fwd Engine Room	SHUT
SE-0-511	Engine Room - Emergency Bilge Draining	Fwd Engine Room	SHUT
SE-0-515	Stbd Fish Hold Room - Bilge Draining	Fwd Engine Room	OPEN
SE-0-516	Fish Hold Room - Bilge Draining	Fwd Engine Room	SHUT
SE-0-517	Steering Gear Room - Bilge Draining	Aft Engine Room	SHUT
SE-0-518	Storage Room - Bilge Draining	Aft Engine Room	SHUT
SE-0-519	Aft Engine Room - Bilge Draining	Aft Engine Room	SHUT
SE-0-527	Port Fish Hold Room - Bilge Draining	Fwd Engine Room	OPEN

### 5-3-5-1. Main Bilge Operation

To operate the bilge system by one or two bilge E-pumps, it is necessary to operate the valves as indicated in the table below:

VALVE N°	VALVE DESCRIPTION	VALVE LOCATION	VALVE POSITION
<b>Dewatering of Steering Gear Room</b>			
SE-0-517	Steering Gear Room - Bilge Draining	Aft Engine Room	OPEN
<b>Dewatering of Storage Room</b>			
SE-0-518	Storage Room - Bilge Draining	Aft Engine Room	OPEN
<b>Dewatering of Engine Room in direct line</b>			
SE-0-509	Fwd Engine Room - Bilge draining	Fwd Engine Room	OPEN
Or /and			
SE-0-519	Aft Engine Room - Bilge Draining	Aft Engine Room	OPEN
<b>Dewatering of Fish Hold Room</b>			
SE-0-516	Fish Hold Room - Bilge Draining	Fwd Engine Room	OPEN

### 5-3-5-2. Emergency dewatering of the engine room by the sea water cooling pump of the main engine

To operate the emergency dewatering the sea water cooling pump of the main engine, it is necessary to operate the valves as indicated in the table below:

VALVE N°	VALVE DESCRIPTION	VALVE LOCATION	VALVE POSITION
SE-0-511	Bilge Engine Room - Emergency Bilge Draining	Fwd Engine Room	OPEN

Doc. Title	Ship Information Handbook		108 / 226
Doc. Reference	23,3 m Trawler		
Doc. Revision & Date	A - 15/09/14		

**5-3-5-3. Emergency dewatering of the engine room by the fire pump**

Refer to the Operating of Sea Water Cooling System



Figure 5-12 Engine Room - Bilge Pumps



Figure 5-13 Engine Room - Bilge Manifold



Figure 5-14 Main Switchboard - Bilge Pumps Control



Figure 5-15 Engine Room - Bilge Pumps Remote Control Panels

**5-3-5-4. Operating of bilge pumps N°1 and N°2 from the Main Switchboard or from the Remote Control Boxes, both located in engine room.**

Close the circuit breakers D13 and D14 in the Main Switchboard EF-0-001.

Press the green push-button to start the pump.

Press the red push-button to stop the pump normally.

In the event of any problem, press the "Emergency stop button" to stop and lock the bilge pump. The bilge pump will not re-start when the button is locked. To unlock, turn the button clockwise in order to reset.

Doc. Title	Ship Information Handbook		109 / 226
Doc. Reference	23,3 m Trawler		
Doc. Revision & Date	A - 15/09/14		

### 5-3-6. Sewage & Sanitary System

The following table shows the valves position to be set to operate the sewage and sanitary system when the ship is in normal operation:

VALVE N°	VALVE DESCRIPTION	VALVE LOCATION	VALVE POSITION
SU-0-501	Crew Quarters Wash Basin, Shower & ACU Condensates - Overboard Discharge	Port Storage Room	OPEN
SU-0-504	Captain Cabin Wash Basin, Sink Galley & ACU Condensates - Overboard Discharge	Port Engine Room	OPEN
SU-0-506	Gravity Toilet - Overboard Discharge	Port Storage Room	OPEN

### 5-3-7. Fuel Transfer Oil System

The following table shows the valves position to be set to operate the fuel oil transfer system when the ship and the machinery equipment are in normal operation and no fuel oil transfer is to be operated:

In the below table, the storage tank N°4 is selected for supply the fuel oil separator.

VALVE N°	VALVE DESCRIPTION	VALVE LOCATION	VALVE POSITION
SG-0-501	Fuel Oil Filling	Port Engine Room	SHUT
SG-0-502	FO Discharge Filter - Isolating Valve	Port Engine Room	SHUT
SG-0-503	FO Suction Filter - Isolating Valve	Port Engine Room	SHUT
SG-0-506	FO Filling Line Sample Cock	Port Engine Room	SHUT
SG-0-509	Main Engine FO Return - Discharge	Port Engine Room	OPEN
SG-0-510	FO Transfert Pumps Suction Filter - Isolating Valve	Port Engine Room	OPEN
SG-0-512	FO Transfert Pumps Discharge Filter - Isolating Valve	Port Engine Room	OPEN
SG-0-513	FO Transfert E-Pump Suction - Isolating Valve	Port Engine Room	OPEN
SG-0-514	FO Transfert Hand-Pump Suction - Isolating Valve	Port Engine Room	SHUT
SG-0-516	FO Transfert E-Pump Discharge - Isolating Valve	Port Engine Room	OPEN
SG-0-517	Transfert Line Sample Cock	Port Engine Room	SHUT
SG-0-518	FO Transfert Hand Pump - Discharge	Port Engine Room	SHUT
SG-0-520	Fuel Oil Tank 1 - Suction	Port Engine Room	SHUT
SG-0-521	Fuel Oil Tank 1 - Filling	Port Engine Room	SHUT
SG-0-522	Fuel Oil Tank 3 - Suction	Port Engine Room	SHUT
SG-0-523	Fuel Oil Tank 1 - Filling	Port Engine Room	SHUT
SG-0-524	Fuel Oil Tank 5 - Suction	Port Engine Room	SHUT
SG-0-525	Fuel Oil Tank 5 - Filling	Port Engine Room	SHUT
SG-0-526	Fuel Oil Tank 4 - Suction	Port Engine Room	OPEN
SG-0-527	Fuel Oil Tank 4 - Filling	Port Engine Room	SHUT
SG-0-528	FO Service Tank 6 - Suction	Port Engine Room	SHUT
SG-0-529	FO Service Tank 6 - Filling	Port Engine Room	SHUT
SG-0-530	Fuel Oil Tank 2 - Suction	Port Engine Room	SHUT
SG-0-531	Fuel Oil Tank 2 - Filling	Port Engine Room	SHUT
SG-0-532	Fuel Oil Tank 4 - Filling / Suction (Remote Controlled Quick Closing Valve)	Port Engine Room	OPEN
SG-0-533	Fuel Oil Tank 4 - Water Draining	Port Engine Room	SHUT
SG-0-534	Fuel Oil Tank 3 - Filling / Suction (Remote Controlled Quick Closing Valve)	Stbd Engine Room	OPEN
SG-0-535	Fuel Oil Tank 3 - Water Draining	Stbd Engine Room	SHUT

Doc. Title	Ship Information Handbook		110 / 226
Doc. Reference	23,3 m Trawler		
Doc. Revision & Date	A - 15/09/14		

VALVE N°	VALVE DESCRIPTION	VALVE LOCATION	VALVE POSITION
SG-0-537	Genset FO Return - Discharge	Port Engine Room	OPEN
SG-0-539	FO Service Tank - Feeding (Remote Controlled Quick Closing Valve)	Port Engine Room	OPEN
SG-0-540	FO Service Tank - Water Draining	Port Engine Room	SHUT
SG-0-542	FO Service Tank - Filling / Suction (Remote Controlled Quick Closing Valve)	Port Engine Room	OPEN
SG-0-543	FO Separator - Discharge	Port Engine Room	OPEN
SG-0-544	Dual Static FO Main Engine Filter - Isolating Valve	Engine Room	OPEN
SG-0-545	Dual Static FO Main Engine Filter - Feeding	Engine Room	To Static Filter
SG-0-546	FO Main Engine - Return	Engine Room	To Serv. Tank
SG-0-547	Single Static FO Genset Filter - Isolating Valve	Port Engine Room	OPEN
SG-0-548	Fuel Oil Tank 2 - Filling / Suction (Remote Controlled Quick Closing Valve)	Port Engine Room	OPEN
SG-0-549	Fuel Oil Tank 2 - Water Draining	Port Engine Room	SHUT
SG-0-550	Fuel Oil Tank 1 - Water Draining	Stbd Engine Room	SHUT
SG-0-551	Fuel Oil Tank 1 - Filling / Suction (Remote Controlled Quick Closing Valve)	Stbd Engine Room	OPEN
SG-0-553	Fuel Oil Tank 5 - Filling / Suction (Remote Controlled Quick Closing Valve)	Fwd Engine Room	OPEN
SG-0-554	Fuel Oil Tank 5 - Water Draining	Fwd Engine Room	SHUT

### 5-3-7-1. Storage Tanks filling from Shore

To replenish fuel oil tanks from the deck connection (Port Side) it is necessary to operate the valves as indicated in the table below:

VALVE N°	VALVE DESCRIPTION	VALVE LOCATION	VALVE POSITION
SG-0-502	Fuel Oil Discharge Filter - Isolating Valve	Port Engine Room	OPEN
SG-0-503	Fuel Oil Suction Filter - Isolating Valve	Port Engine Room	OPEN
SG-0-521	Fuel Oil Tank 1 - Filling	Port Engine Room	
SG-0-523	Fuel Oil Tank 1 - Filling	Port Engine Room	OPEN
SG-0-525	Fuel Oil Tank 5 - Filling	Port Engine Room	OPEN
SG-0-531	Fuel Oil Tank 2 - Filling	Port Engine Room	OPEN

### 5-3-7-2. Transfer N°5 Storage Tank to N°4 Storage Tank (for example)

To replenish fuel oil storage tanks N°4 from fuel oil storage tanks N°5, it is necessary to operate the valves as indicated in the table below:

VALVE N°	VALVE DESCRIPTION	VALVE LOCATION	VALVE POSITION
SG-0-524	Fishing Hold Room FO Tank 5 - Suction	Port Engine Room	OPEN
SG-0-527	Port Engine Room Tank 4 - Filling	Port Engine Room	OPEN

Doc. Title	Ship Information Handbook		111 / 226
Doc. Reference	23,3 m Trawler		
Doc. Revision & Date	A - 15/09/14		



Figure 5-16 Port Engine Room - FO Transfer Pump and Centrifugal Separator



Figure 5-17 Main Switchboard - FO Transfer Pump Control Panel



Figure 5-18 Engine Room - FO Transfer Pump Remote Control Panel

**5-3-7-3. Operating of FO transfer pump from the Main Switchboard or from the Remote Control Box, both located in engine room**

Close the circuit breaker D07 in the Main Switchboard EF-0-001.

Press the red push-button to stop the pump normally.

In the event of any problem, press the "Emergency stop button" to stop and lock the FO pump.

The FO pump will not re-start when the button is locked. To unlock, turn the button clockwise in order to reset.



Figure 5-19 CO2 Room - FO Quick Closing Valves

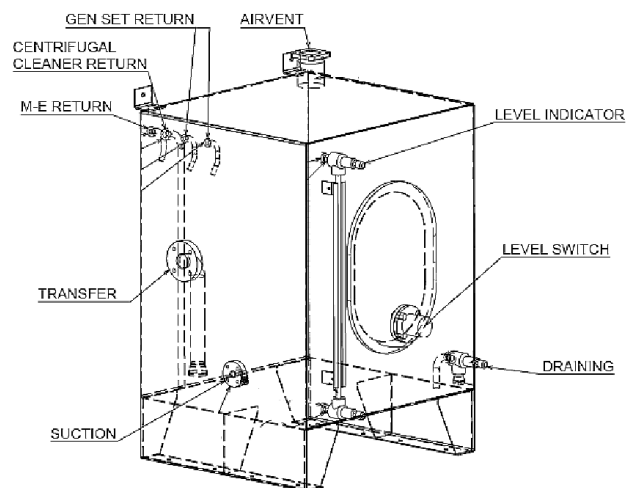



Figure 5-20 Engine Room - Fuel Oil Service Tank

Doc. Title	Ship Information Handbook		112 / 226
Doc. Reference	23,3 m Trawler		
Doc. Revision & Date	A - 15/09/14		



**5-3-7-4. Operating of FO centrifugal separator**

Close the circuit breaker D28 in the Main Switchboard EF-0-001 to supply the separator.  
On the control panel of separator, press the push-button (keep the button pressed 3 - 4 seconds) to start the separator.

**5-3-8. Lubricating Oil Transfer System**

The following table show the valves position to be set to operate the lubricating oil system when the machinery equipment are in normal operation and no lub.oil transfer is to be operated:

VALVE N°	VALVE DESCRIPTION	VALVE LOCATION	VALVE POSITION
SL-0-502	Polluted Oil Tank - Discharge	Engine Room	SHUT
SL-0-503	Polluted Oil Tank - Suction	Engine Room	SHUT
SL-0-504	Polluted Oil Tank - Draining	Engine Room	SHUT
SL-0-506	Polluted Oil Tank - Funnel Discharge	Engine Room	SHUT
SL-0-507	Polluted Oil Tank - Filling	Engine Room	OPEN
SL-0-508	New Lub. Oil Tank - Tapping cock	Engine Room	SHUT
SL-0-509	New Oil Filling - Filter Isolating Valve	Engine Room	SHUT
SL-0-511	New Oil Filling - Filter Isolating Valve	Engine Room	OPEN
SL-0-512	Polluted Hand Pump - Suction	Engine Room	SHUT
SL-0-514	Condensate Trap - Discharge (ME Crankcase Breather )	Main Deck	OPEN
SL-0-516	Genset Polluted Oil - Discharge	Port Engine Room	SHUT

**5-3-8-1. Storage new oil tank filling from Shore**

To replenish lubricating oil tank from the filling station (Port Side) it is necessary to operate the valves as indicated in the table below:

VALVE N°	VALVE DESCRIPTION	VALVE LOCATION	VALVE POSITION
SL-0-509	Lub. Oil Filling Station - Discharge (Inlet Filter)	Engine Room	OPEN

**5-3-8-2. Draining of Genset Polluted Oil**

To drain polluted oil from Genset it is necessary to operate the valves as indicated in the table below:

VALVE N°	VALVE DESCRIPTION	VALVE LOCATION	VALVE POSITION
SL-0-516	Port Genset Polluted Oil - Discharge	Port Engine Room	OPEN

**5-3-8-3. Polluted oil tank discharge**

To drain polluted oil from polluted oil tank it is necessary to operate the valves as indicated in the table below:

Doc. Title	Ship Information Handbook		113 / 226
Doc. Reference	23,3 m Trawler		
Doc. Revision & Date	A - 15/09/14		

VALVE N°	VALVE DESCRIPTION	VALVE LOCATION	VALVE POSITION
SL-0-502	Polluted Oil Tank - Discharge	Engine Room	OPEN
SL-0-503	Polluted Oil Tank - Hand Pump Suction	Engine Room	OPEN

All transferring operations are performed by hand pumps.



Figure 5-21 Stbd Engine Room -  
Lubricating oil  
Transfer Hand Pump

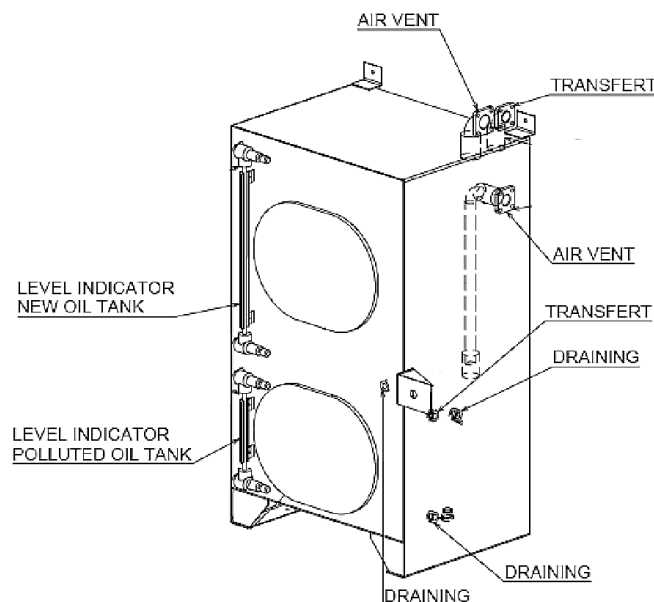

Figure 5-22 Engine Room -  
New Oil & Polluted Oil Tanks

### 5-3-9. CO2 Firefighting System

#### 5-3-9-1. CO2 Firefighting System

The CO2 Firefighting System is located in the CO2 Storage Room in the main deck alleyway. The CO2 Firefighting System protects the engine room and workshop.

The CO2 Firefighting system includes mainly:

- Two pressurized gas cylinders of 50 litre each equipped with manual / pneumatic valve. The cylinder 1, equipped with a mechanical release lever allows the release of the cylinder 2 by CO2 pressure
- One pressure meter
- One isolating valve
- One pressure switch fitted on a closed manifold and connected to ship alarm monitoring system to detect CO2 cylinders leaking
- Two visual and audible alarms

The opening of CO2 room door causes tripping of visual and audible alarms in engine room and workshop.

Doc. Title	Ship Information Handbook		114 / 226
Doc. Reference	23,3 m Trawler		
Doc. Revision & Date	A - 15/09/14		



Figure 5-23 CO2 Cylinders 1 and 2



Figure 5-24 Mechanical Release Lever (Cylinder 1) and Pneumatic Release (Cylinder 2)



Figure 5-25 CO2 Isolating Valve

**5-3-9-2. Standby Operation**

The both cylinders are charged with 50kg CO2.  
 The mechanical release lever is armed and secured by pin.  
 The isolation valve is shut.  
 The CO2 manifold is closed at 0 bar pressure.  
 In case of cylinder leaks in closed manifold, alarm is activated in wheelhouse.

Doc. Title	Ship Information Handbook		115 / 226
Doc. Reference	23,3 m Trawler		
Doc. Revision & Date	A - 15/09/14		

**5-3-9-3. Firefighting Operation (in the event of engine fire)**

Open the door of the CO2 storage room.

- Alarms are activated in engine room and workshop,
- Ventilation is shutdown in engine room and workshop,
- "CO2 DOOR OPENED" alarm on the wheelhouse monitoring panel is activated,
- Actuate the both FO quick closing valves.
- Ensure that engine room and workshop are clear of personnel.
- Close all the openings; engine room air intake included.
- Wait approximately 30 seconds.
- Open manually the CO2 isolating valve (top of CO2 cylinder 1).
- Remove pin of Pilot Cylinder Valve.
- Actuate manually the CO2 Pilot Cylinder Valve by sharply pulling the lever on top of the valve.
- The pressure of pilot cylinder activates the CO2 cylinder 2.
- CO2 of both cylinders is discharged in the machinery space.

THE CO2 CONCENTRATION MUST BE RETAINED WITHIN THE MACHINERY SPACE DURING 20 MINUTES FOR MINIMUM.

DO NOT RE-ENTER THE AREA AS IT IS NOT CONSIDERED TO BE SAFE.

**5-3-10. AC 400V-3-50Hz Production Network**

The 400V-50Hz electrical outputs of the shaft generator, the genset and shore supply connection are supplied via Motor Controlled Circuit Breakers (MCCB) to individual busbar sections of the Main Switchboard EF-0-001 located in Engine Room.

Main Electrical Switchboard EF-0-001 - AC 400V Supply Cell

Circuit Breaker	Nb. of Poles	Rating (Amps)	Supplier	Consumer Index	Location
CB1	4	160A	Shaft Generator - Output	ED-0-001	Engine Room
CB2	4	80A	Generator Set - Output	ED-0-002	Engine Room
CB3	4	80A	Shore Supply Socket - Output	EF-0-002	Main Deck Alleyway
Q1	4	6A	Multi-Measurement - Input Voltage		
Q2	4	6A	Multi-Measurement - Genset Input Voltage	ED-0-002	Engine Room
Q3	4	6A	Multi-Measurement - Shaft Generator Input Voltage	ED-0-001	Engine Room
Q4	4	4A	Multi-Measurement - Busbar Input Voltage		

**5-3-10-1. General**

The shaft generator is driven by the reduction gearbox of the propulsion plant.

The installation of the 100kVA shaft generator requires that the propulsion engine is constantly running at its rated speed.

To power the network at 50Hz frequency, the shaft generator driven by the propulsion plant, must turn at the fixed regime of 1500rpm.

The shaft generator is driven by a constant PTO drive (ratio 1.0795 / 1) at 1500rpm corresponding to a nominal engine regime of 1619rpm.

The Genset is started manually, either locally or from the wheelhouse.

In case of overload, an automatic load shedding is performed.

The frequency control is provided by two buttons "SPEED +" & "SPEED -"

Doc. Title	Ship Information Handbook		116 / 226
Doc. Reference	23,3 m Trawler		
Doc. Revision & Date	A - 15/09/14		



Figure 5-26 Main Electrical Switchboard - Production Cell

### 5-3-11. AC 400V-3-50Hz Distribution Network

All 440V supplies to ship services are provided by a switchboard distribution section located on the right of the main switchboard EF-0-001 located in the engine room.

Electrical distribution of AC400V is realized according to the following electrical distribution table:

Main Electrical Switchboard EF-0-001 - AC 400V Distribution Cell

Circuit Breaker	Nb. of Poles	Rating (Amps)	Consumer	Consumer Index	Location
D01	3	10A	Steering Gear Starter Panel - Pump 1	QB-0-001	Steering Gear Room
D02	3	10A	Steering Gear Starter Panel - Pump 2	QB-0-002	Steering Gear Room
D03	3	80A	Fish Hold Refrigeration Electrical Control Cabinet	QV-0-100	Storage Room
D04	3	20A	Spare		Fwd Peak
D05	3	6,3/10A	Spare		Stbd Mast Foot
D06	3	10/16A	Engine Room Exhaust Fan	SC-0-014	Stbd Mast Foot
D07	3	6,3/10A	Fuel, Oil Transfer Pump	SG-0-001	Engine Room
D08	3	6A	Fish Convoyer	EF-0-010	Engine Room
D09	3	2A	Spare		
D10	3	20A	Water Heater 1	SD-0-002	Galley
D11	3	20A	Water Heater 2	SD-0-003	Crew Quarters
D12	3	10/16A	Fire Pump	SM-0-001	Engine Room
D13	3	6,3/10A	Bilge Pump 1	SE-0-001	Engine Room
D14	3	6,3/10A	Bilge Pump 2	SE-0-002	Engine Room
D16	3	2A	Washing Pressure Pump (Toilet)	SM-0-002	Engine Room
D17	3	4A	Fresh Water Pressure Pump	SD-0-001	Engine Room
D18	3	4/6,3A	Fishing Gear Hydraulic Power Pack - Cooling Pump	MM-0-001	Engine Room
D19	3	10A	Spare		

Doc. Title	Ship Information Handbook		117 / 226
Doc. Reference	23,3 m Trawler		
Doc. Revision & Date	A - 15/09/14		

### 5-3-12. AC 230 Distribution Network

All 230V supplies to ship services are provided by:

- A switchboard distribution section located on the centre of the main switchboard EF-0-001,
- An engine room distribution panel EE-0-001
- A wheelhouse distribution frame EE-0-002
- A workshop distribution panel EE-0-003

Electrical distribution of AC230V is realized according to the following electrical distribution tables:

#### Main Electrical Switchboard EF-0-001 - AC 230V Distribution Cell

Circuit Breaker	Nb. of Poles	Rating (Amps)	Consumer	Consumer Index	Location
D15	4	20A	Electric Cooker	QC-0-001	Galley
D20	4	25A	Wheelhouse AC230V Distribution Frame	EE-0-002	Wheelhouse
			Wheelhouse DC24V Distribution Frame	EB-0-007	Wheelhouse
D21	4	20A	Main Deck AC230V Distribution Panel	EE-0-003	Main Deck
			Wheelhouse DC24V Distribution Frame	EB-0-007	Wheelhouse
D22	4	16A	Lower Deck AC230V Distribution Panel	EE-0-001	Lower Deck
			Wheelhouse DC24V Distribution Frame	EB-0-007	Wheelhouse
D23	2	16A	Sanitary & Provision Store Ventilation Fans - Junction Box	SC-2-016	Engine Room
D24	2	16A	ACU - Galley	SC-0-023	Galley
D25	2	16A	ACU - Crew Accomodations	SC-0-020	Crew Quarters
D26	2	10A	Refrigerator	QC-0-002	Galley
D27	2	10A	Loading Mast Junction Box	EE-2-200	Fwd Peak
D28	3	6,3/10A	FO Separator	SG-0-002	Engine Room
D29	2	1A	Shaft Generator - Anti Condensation Heater	ED-0-001	Engine Room
D30	2	1A	Genset - Anti Condensation Heater	ED-0-002	Engine Room
D31	2	4/6,3A	AC Sea Water Pump Relay Box	SC-0-030	Engine Room
D32	2	10A	DC24V Battery Charger	EB-0-001	Engine Room
D33	2	16A	Spare		
D34	2	16A	ACU Wheelhouse	SC-0-026	Wheelhouse
D35	2	16A	Spare		

#### Engine Room Distribution Panel EE-0-001

Circuit Breaker	Nb. of Poles	Rating (Amps)	Consumer	Consumer Index	Location
D01	2	10A	Steering Room Lighting - Junction Box	EE-2-120	Steering Room
D02	2	10A	Storage Room Lighting - Junction Box	EE-2-119	Storage Room
D03	2	10A	Engine Room Lighting - Junction Box	EE-2-117	Engine Room
D04	2	10A	Fishing Area Lighting - Junction Box	EE-2-102	Aft Fishing Deck
D05	2	16A	Engine Room Socket	EE-0-197	Engine Room
D06	2	16A	Engine Room Socket	EE-0-199	Engine Room
D07	2	10A	Spare		

Doc. Title	Ship Information Handbook		118 / 226
Doc. Reference	23,3 m Trawler		
Doc. Revision & Date	A - 15/09/14		

## Wheelhouse Distribution Frame EE-0-002

Circuit Breaker	Nb. of Poles	Rating (Amps)	Consumer	Consumer Index	Location
D01	2	10A	Wheelhouse Lighting - Junction Box	EE-2-101	Wheelhouse
D02	2	10A	Captain Cabin Lighting - Junction Box	EE-2-104	Captain Cabin
D03	4	16A	External Lightning Panel	EE-0-108	Wheelhouse
D04	2	16A	Sockets - Junction Box	EE-2-190	Wheelhouse
D05	2	10A	Spare		
D06	2	2A	Bilge Alarm Panel - Converter	MO-0-004	Wheelhouse
D07	2	16A	Window Heaters - Junction Box	EE-2-116	Wheelhouse
D08	2	4A	Navigation Lights Panel - converter	ES-0-002	Wheelhouse
D09	2	2A	Fire Detection Panel- Converter	SI-0-006	Wheelhouse
D10	2	6A	GMDSS Battery Charger	EB-0-002	Wheelhouse

## Workshop Distribution Panel EE-0-003

Circuit Breaker	Nb. of Poles	Rating (Amps)	Consumer	Consumer Index	Location
D01	2	10A	Alleyway Lighting - Junction Box	EE-2-109	Main Deck Alleyway
D02	2	10A	Alleyway Lighting - Junction Box	EE-2-110	Main Deck Alleyway
D03	2	10A	Provision Store Lighting - Junction Box	EE-2-146	Provision Store
D04	2	10A	Workshop Lighting - Junction Box	EE-2-106	Workshop
D05	2	10A	Galley Lighting - Junction Box	EE-2-107	Galley
D06	2	10A	Fore Peak Lighting - Junction Box	EE-2-111	Fore Peak
D07	2	10A	Crew Quarters Lighting - Junction Box	EE-2-193	Crew Quarters
D08	2	10A	Sanitary Lighting - Junction Box	EE-2-112	Sanitary
D09	2	16A	Allayway Sockets	EE-0-196	Main Deck Alleyway
D10	2	16A	Workshop Sockets	EE-0-185	Workshop
D11	2	16A	Galley Sockets - Junction Box	EE-2-187	Galley
D12	2	16A	Crew Quarters Sockets - Junction Box	EE-2-193	Crew Quarters
D13	2	6A	Spare		
D14	2	10A	Spare		

**5-3-13. DC 24V Distribution Network**

All DC24V supplies to ship services are provided by the wheelhouse distribution frame EB-0-007. Electrical distribution of DC24V is realized according to the following electrical distribution table:

## Wheelhouse Distribution Frame EB-0-007

Circuit Breaker	Nb. of Poles	Rating (Amps)	Consumer	Consumer Index	Location
D01	2	25A	GMDSS Battery Charger	EB-0-002	Stbd Bridge Desk
D02	2	4A	Lower Deck Emergency Lighting - Junction Box	EB-2-106	Storage Room
D03	2	4A	Main Deck Emergency Lighting - Junction Box	EB-2-105	Main Deck Alleyway
D04	2	25A	Upper Deck Emergency Lighting - Junction Box	EB-2-101	Wheelhouse
D05	2	1A	AIS Transponder	NL-0-030	Main Bridge Desk
D06	2	4A	Public Adress System	TI-0-010	Main Bridge Desk
D07	2	1A	Magnetic Compass	NL-0-003	Main Bridge Desk
D08	2	1A	Satellite Compass	NL-0-106	Wheelhouse
D09	2	1A	GPS	NL-0-006	Wheelhouse
D10	2	4A	Echo Sounder	NL-0-001	Main Bridge Desk

Doc. Title	Ship Information Handbook		119 / 226
Doc. Reference	23,3 m Trawler		
Doc. Revision & Date	A - 15/09/14		

Circuit Breaker	Nb. of Poles	Rating (Amps)	Consumer	Consumer Index	Location
D11	2	6A	48Nm X Band Marine Radar	NL-0-005	Main Bridge Desk
D12	2	4A	36Nm X Band Marine Radar	NL-0-004	Main Bridge Desk
D13	2	10A	ECDIS - Personal Computer	NL-0-007	Wheelhouse
			Power Supply DC24/24V	NL-0-039	Wheelhouse
D14	2	1A	Auto Pilot Calculator	NL-0-012	Main Bridge Desk
D15	2	1A	Remote Display	NL-0-008	Over Head Bridge Desk
			Remote Display	NL-0-009	Over Head Bridge Desk
D16	2	10A	Windscreen Wipers - Terminal Block	ES-0-039	Main Bridge Desk
D17	2	2A	CO2 Fire Extinction System - Junction Box	MO-2-005	Eng. Room
D18	2	2A	Fire Detection Panel	SI-0-001	Wheelhouse
D19	2	6A	CCTV Screen Display	TI-0-100	Main Bridge Desk
			CCTV Camera - Junction Box	TI-2-200	Workshop
D20	2	2A	Bilge Alarm Acquisition Box	MO-0-002	Stbd Bridge Desk
D21	2	2A	General Alarm Panel	MO-0-003	Stbd Bridge Desk
D22	2	10A	Computer IX Blue	NL-0-017	Stbd Bridge Desk
			Power Supply DC24/24V	NL-0-040	Stbd Bridge Desk
D23	2	20A	Navigation Lights Panel	ES-0-001	Stbd Bridge Desk
D24	2	1A	Chart Table Light - Junction Box	EB-2-104	Wheelhouse
D25	2	1A	Navtex Receiver	NL-0-024	Stbd Bridge Desk
D26	2	1A	Buffer NMEA	NL-0-021	Main Bridge Desk
D27	2	10A	Main Switchboard	EF-0-001	Eng. Room
D28	2	10A	Horm Control Panel	ES-0-003	Main Bridge Desk
			Horm Air Compressor	ES-0-004	Wheelhouse
D29	2	1A	Bridge Navigational Watch Alarm System	EB-0-138	Main Bridge Desk
D30	2	4A	SC70 Calculator - Converter	NL-0-075	Stbd Bridge Desk
D31	2	1A	Auto Pilot Display	NL-0-015	Main Bridge Desk
D32	2	4A	Weather Station	NL-0-076	Main Bridge Desk
D33	2	4A	VMS Transformer	NL-0-059	Main Bridge Desk
D34	2	1A	Rudder Angle Repetitor - Converter	NL-0-011	Main Bridge Desk
D35	2	4A	Steering Control Panel	QB-0-003	Wheelhouse
D36	2	4A	VHF Marine Radiotelephone - Converter	NL-0-041	Main Bridge Desk
D37	2	4A	Amplified Batteryless Telephone system - Main Station	TI-0-006	Engine Room
D38	2	6A	CPP - Control Panel	MO-0-103	Fore Fishing Deck
D39	2	10A	Spare		
D40	2	3A	Fishing Gear Control panel	EF-0-004	Aft Fishing Deck

### 5-3-14. Electrical Plant

#### 5-3-14-1. Starting of the Genset

Before starting, ensure that pre-operational checks on the generators and generator engines are performed, mainly for:

- Sea Water Cooling System
- Fuel Oil supply
- Oil and Coolant levels

Do not start any engine if there is a warning tag attached to the start panel.

- Main electrical Switchboard EF-0-001
- Ensure that the selector "SWITCHBOARD LIGHTING" is on the "ON" position. The facade of the switchboard will remain lighted during the blackout

Doc. Title	Ship Information Handbook		120 / 226
Doc. Reference	23,3 m Trawler		
Doc. Revision & Date	A - 15/09/14		



- Minimize electrical load before starting

**Starting Genset from Engine Room**

- On GENSET wheelhouse Remote Control Panel
    - Ensure that the START knob of GENSET is on the "STOP" position
  - GENSET Control Panel
    - Switch the battery master key to the "ON" position
    - Turn the START knob to "RUN" position. The engine do not starts when knob is on "AUTO" position
- => The engine starts

**Starting from Wheelhouse**

- GENSET Control Panel
    - Switch the battery master key to the "ON" position
    - Turn the START knob to "AUTO" position
  - GENSET Wheelhouse Remote Control Panel
    - Turn the knob to the "RUN" position
- => The engine starts



Figure 5-27 Main Electrical Switchboard - Production Cell



Figure 5-28 Genset - Battery Mastey Key



Figure 5-29 Genset - Control Panel



Figure 5-30 Genset - Bridge Remote Control Panel

Doc. Title	Ship Information Handbook		121 / 226
Doc. Reference	23,3 m Trawler		
Doc. Revision & Date	A - 15/09/14		

**After starting engine**

- Check that engine parameters are nominals
- Run the engine at no load before connect the generator with the main switchboard until the coolant temperature warms up
- Check for any fluid leaks and air leaks at idle rpm and at one-half full rpm before operating the engine under load

**5-3-14-2. Stopping of the Genset**

Emergency shutoff controls are for emergency use ONLY. Do not use emergency shutoff devices or controls for normal stopping procedure.

- Main electrical Switchboard EF-0-001
  - Remove the load from the Genset

**Normal Stopping Genset from Engine Room**

- GENSET Control Panel
  - Turn the START knob to "AUTO" position
 => The engine stops

**Normal Stopping Genset from Wheelhouse**

- GENSET Remote Control Panel
  - Turn the START knob to "STOP" position
 => The engine stops

**Emergency Stopping of Genset**

- Emergency Stopping from GENSET Control Panel
  - Press the RED emergency "STOP" pushbutton
 => Alarm sounds and lights on both control panels  
 => The engine stops

- Inhibit sounds with mute switch

The engine will not re-start when the button is locked. Turn the button clockwise in order to reset.

- Emergency Stopping from GENSET Remote Control Panel
  - Press the RED emergency "STOP" pushbutton
 => Alarm sounds and lights on both control panels  
 => The engine stops

- Inhibit sounds with mute switch

The engine will not re-start when the button is locked. Turn the button clockwise in order to reset.

Doc. Title	Ship Information Handbook		122 / 226
Doc. Reference	23,3 m Trawler		
Doc. Revision & Date	A - 15/09/14		

**5-3-14-3. Switching to Genset Supply Power**

The ship is considered electrically powered by shore supply.

- Main electrical Switchboard EF-0-001
  - Call warning of black-out to connect the onboard power supply
  - Open the shore circuit breaker by pressing the black push button "OPENING CIRCUIT BREAKER SHORE SOCKET"
- => The ship loses momentarily AC400V and AC230V power
  - Close the genset circuit breaker by pressing the black push button "CLOSING CIRCUIT BREAKER GENSET"
- => The genset supply the busbar of the main switchboard
  - Check the multi-measurement unit for correct voltage and frequency
  - Manage manually the speed and frequency by pressing on black push buttons "SPEED+" or "SPEED-" to equilibrate 50Hz frequency
- => In case of overload, an automatic load shedding is performed.

**Overload Situation**

If such situation occurs despite the automatic downloading of certain consumers, it is necessary to minimize the electrical load and remake the start cycle of Genset.

**5-3-14-4. Switching to Shaft Generator Supply Power**

The ship is considered electrically powered by Genset.

The main engine is considered running at the nominal speed of 1619rpm

- Main electrical Switchboard EF-0-001
  - Call warning of black-out to connect the onboard power supply
  - Open the Genset circuit breaker by pressing the black push button "OPENING CIRCUIT BREAKER GENSET"
- => The ship loses momentarily AC400V and AC230V power
  - Close the Shaft Generator circuit breaker by pressing the black push button "CLOSING CIRCUIT BREAKER SHAFT GENERATOR"
- => The shaft generator supply the busbar of the main switchboard
  - Check the multi-measurement unit for correct voltage and frequency

**5-3-14-5. Switching to Shore Supply Power**

- Connect shore supply cable to shore socket
- Call warning of black-out to connect the onboard power supply
- Main electrical Switchboard EF-0-001
  - Remove or minimize the load from the Genset
  - Open the Genset circuit breaker by pressing the black push button "OPENING CIRCUIT BREAKER GENSET"
- => The ship loses momentarily AC400V and AC230V power

Doc. Title	Ship Information Handbook		123 / 226
Doc. Reference	23,3 m Trawler		
Doc. Revision & Date	A - 15/09/14		

- Close the shore supply circuit breaker by pressing the black push button "CLOSING CIRCUIT BREAKER SHORE SOCKET"
- => The shore supply the busbar of the main switchboard
- Check the multi-measurement unit for correct voltage and frequency
- => The protective overload and reverse relay ensure that 3-phase current and phase voltage is correct
- Stop the Genset

### 5-3-15. Ship's Alarms & Monitoring Devices

The alarms & monitoring devices includes:

- One Bilge Alarm Panel MO-0-001 located on the stbd bridge desk
- One General Alarm Panel MO-0-003 located on the stbd bridge desk
- One Bridge Navigational Watch Alarm Box EB-0-138 located on the main bridge desk
- One Navigation Lights Monitoring & Control Panel ES-0-001 located on the stbd bridge desk
- One Fire Detection Panel SI-0-001 located
- One Rudder Angle Indicators NL-0-023 located on the main bridge desk

#### 5-3-15-1. Bilge Alarm Panel MO-0-001 - Marinelec ALTOR 8

The ALTOR 8 is equipment designed to monitor the status of 8 flooding level sensors and to generate an audible and visual alarm when the sensor changes state.

In order to dispense with intemperstives alarms, a timer is programmable on all channels.



Figure 5-31 Bridge - Bilge Alarm Panel

Doc. Title	Ship Information Handbook		124 / 226
Doc. Reference	23,3 m Trawler		
Doc. Revision & Date	A - 15/09/14		

**ALTOR 8 Alarm Configuration**

Channel 1	Flooding Water Level - Fish Hold Room	HIGH BILGE - FISH HOLD
Channel 2	Flooding Water Level - Fore Engine Room	HIGH BILGE - MACHINERY ROOM FORE
Channel 3	Flooding Water Level - Aft Engine Room	HIGH BILGE - MACHINERY ROOM AFT
Channel 4	Flooding Water Level - Storage Room	HIGH BILGE - STORAGE ROOM
Channel 5	Flooding Water Level - Steering Gear Room	HIGH BILGE - STEERING GEAR ROOM
Channel 6	Not programmed	
Channel 7	Not programmed	
Channel 8	Not programmed	

**5-3-15-2. General Alarm Panel MO-0-003 - Marinelec ALTAİR 16V2 type**

The ALTAİR 16V2 is equipment designed to monitor the status of 16 dry sensors and to generate an audible and visual alarm when the sensor changes state.



Figure 5-32 Bridge - General Alarm Panel

**ALTAİR 16V2 Alarm Configuration**

Channel	Function	Alarm Message
Channel 1	Low Level - Fuel Oil Storage Tank DT2 (Port Storage Room)	LAL - FO TANK PORT
Channel 2	Low Level - Fuel Oil Storage Tank DT1 (Stbd Storage Room)	LAL - FO TANK STBD
Channel 3	High Level - Fuel Oil Storage / Overflow Tank C T2 (Port Engine)	LAH - FO / OVERFLOW TANK PORT
Channel 4	Low Level - Fuel Oil Storage / Overflow Tank C T2 (Port Engine)	LAL - FO / OVERFLOW TANK PORT
Channel 5	High Level - Fuel Oil Service Tank C R1 (Port Engine Room)	LAL - FO / SERVICE TANK
Channel 6	High Level - Fuel Oil Storage / Overflow Tank C T1 (Stbd Engine)	LAL - FO / OVERFLOW TANK STBD
Channel 7	Low Level - Fuel Oil Storage / Overflow Tank C T1 (Stbd Engine)	LAH - FO / OVERFLOW TANK STBD
Channel 8	Low Level - Fuel Oil Storage Tank B T10 (Fish Hold Room)	LAL - FO TANK FORE
Channel 9	Low Level Fresh Water Tank A T10 (Fore Peak)	LAL - FRESH WATER TANK FORE
Channel 10	Low Level Fresh Water Tank D T10 (Fwd Storage Room)	LAL - FRESH WATER TANK AFT
Channel 11	Insulation Fault - Main Switchboard EF-0-001	INSULATION FAULT - EF-0-001
Channel 12	Insulation Fault - Distribution Frame DC24V Wheelhouse EB-0-007	INSULATION FAULT - EB-0-007
Channel 13	Troubleshooting - Main Battery Charger EB-0-001	MAIN BATTERY CHARGER FAULT
Channel 14	Low Level Stern Tube Lubricating Oil Tanks (Workshop & Storage Room)	LAL - STERN TUBE LUBE OIL TANK
Channel 15	Low Pressure in CO2 Bottles	CO2 LEAK ON BOTTLE
Channel 16	CO2 Room Door Switch	CO2 DOOR OPENED

Doc. Title	Ship Information Handbook		125 / 226
Doc. Reference	23,3 m Trawler		
Doc. Revision & Date	A - 15/09/14		

Notes: LAL => Low Alarm Level at 30% Tank Capacity  
 LAH => High Alarm Level at 90% Tank Capacity



Figure 5-33 Bridge - Navigational Watch Alarm

**5-3-15-3. Bridge Navigational Watch Alarm Box EB-0-138 - Marinelec LYNX V3S**

The Bridge Navigational Watch Alarm System (BNWAS) detects the operator disability. The BNWAS has to be reset periodically with a push button.

**5-3-15-4. Navigation Lights Monitoring & Control Panel ES-0-001 - Marinelec NORMA 14CPDC**

The NORMA 14CPDC is navigation lights control and alarm system. It allows monitoring and controlling 14 navigation lights rated. Navigation Lights are controlled from a remote control panel.

**NORMA 14CPDC Alarm Configuration**

Alarm	Function
Red LED	Navigation Light Failure
Yellow LED	NORMA System Failure



Figure 5-34 Bridge - Navigation Lights Monitoring & Control Panel

Doc. Title	Ship Information Handbook		126 / 226
Doc. Reference	23,3 m Trawler		
Doc. Revision & Date	A - 15/09/14		

### 5-3-16. Main propulsion Engine

#### 5-3-16-1. Monitoring and Control System

The monitoring and control system includes in engine room:

- One Caterpillar MECP-1 Engine Control Panel

and in wheelhouse:

- One Caterpillar Engine Remote Control Panel
- One Kobelt Bridge Mechanical Control Head (Lever) actuating an Electronic Clutch Control Potentiometer



Figure 5-35 Bridge - MECP-1 Engine Control Panel



Figure 5-36 Bridge - Engine Remote Control Panel



Figure 5-37 Bridge Mechanical Control Head



Figure 5-38 Engine Room - ME Battery Master Key

Doc. Title	Ship Information Handbook		127 / 226
Doc. Reference	23,3 m Trawler		
Doc. Revision & Date	A - 15/09/14		

**5-3-16-2. Starting of the Main Propulsion Engine**

Before starting, ensure that pre-operational checks on the main engine are performed, mainly for:

- Sea water cooling system
- Fuel oil supply system
- Oil and coolant levels for main engine

Ensure that valves of fuel oil and sea water cooling systems are correctly operated.

Do not start main engine if there is a warning tag attached to the start panel.

The main engine can be started locally (engine room) or remotely from wheelhouse.

To allow starting up from the wheelhouse, switch the selector of the MECP-1 engine room panel in "Remote" position.

On the engine remote control panel (wheelhouse), the selector "SHUTDOWN OVERRIDE" prevents the automatic engine shutdown in event of alarm.

Start main propulsion engine as follows:

**Local Starting**

- Switch the battery master key to the "ON" position
    - Bridge Mechanical Control Head
      - Ensure that control lever is at NEUTRAL position
    - MECP-1 Engine Control Panel
      - Select the "OFF/MANUAL/REMOTE" switch to the "MANUAL" position
      - Push the green "START" button to start the engine
- => The engine starts

**Starting from Wheelhouse**

- Switch the battery master key to the "ON" position
    - MECP-1 Engine Control Panel
      - Select the "OFF/MANUAL/REMOTE" switch to the "REMOTE" position
    - Bridge Mechanical Control Head
      - Ensure that control lever is at NEUTRAL position
    - Engine Remote Control Panel
      - Turn the Key Switch in the "START" position to start the engine.
- => The engine starts

**After starting engine**

- Run the engine at no load to warm-up during five minits approximately
- Check that engine parameters are nominals
- During warm-up phase, check for any fluid leaks and air leaks at idle rpm
- Observe the water discharge at the sea water outlet. If water discharge is not visible or the water flow is restricted, stop the engine immediately and inspect sea water cooling system

Doc. Title	Ship Information Handbook		128 / 226
Doc. Reference	23,3 m Trawler		
Doc. Revision & Date	A - 15/09/14		



### 5-3-16-3. Stopping of the Main Propulsion Engine

Emergency shutoff controls are for EMERGENCY USE ONLY. Do not use emergency shutoff devices or controls for normal stopping procedure.

Stopping the engine immediately after it has been working under load can result in over heating and accelerated wear of the engine components.

If the engine has been operating at high rpm and/or high loads, run at low idle for least three minutes to reduce and stabilize internal engine temperature before stopping the engine.

Avoiding hot engine shutdowns will maximize turbo-charger shaft and bearing life.

#### Normal Local Stopping

- From MECP-1 Engine Control Panel
    - Decrease the engine rpm to no more than 50 percent of the rated rpm for 3 to 5 minutes in order to cool the engine
    - Reduce the engine rpm to low idle
    - Push the "STOP" red button to stop the engine
- => The engine stops

#### Emergency Stopping from Wheelhouse Engine Remote Control Panel

- Push the "EMERGENCY STOP" red button to stop the engine. The main engine will not re-start when the button is locked. To unlock, turn the button clockwise in order to reset.

### 5-3-16-4. C32 Engine and C4.4 Genset Engine – Event Codes

The Electronic Control Module (ECM) monitors the operating parameters of the engine.

The ECM will generate an event code if a specific engine parameter exceeds an acceptable range that is defined by the engine monitoring system.

For information on the engine monitoring system, refer to Troubleshooting of Caterpillar Operation and Maintenance Manuals of C32 and C4.4 engines, "Engine Monitoring System".

Event codes are generated when abnormal operating conditions exist.

The table is a list of the event codes for the engine.

The event codes are cross-referenced with the appropriate procedure that can be used to troubleshoot the code.

Code	Warning Category Indicator	SPN-FMI Code	Description	Troubleshooting Procedure	Default
1-5		651-5	Cylinder #1 Injector Current Above Normal	Troubleshooting, "Injector Solenoid - Test"	
1-6		651-6	Cylinder #1 Injector Current Below Normal	Troubleshooting, "Injector Solenoid - Test"	
2-5		652-5	Cylinder #2 Injector Current Above Normal	Troubleshooting, "Injector Solenoid - Test"	
2-6		652-6	Cylinder #2 Injector Current Below Normal	Troubleshooting, "Injector Solenoid - Test"	
3-5		653-5	Cylinder #3 Injector Current Above Normal	Troubleshooting, "Injector Solenoid - Test"	
3-6		653-6	Cylinder #3 Injector Current Below Normal	Troubleshooting, "Injector Solenoid - Test"	
4-5		654-5	Cylinder #4 Injector Current Above Normal	Troubleshooting, "Injector Solenoid - Test"	

Doc. Title	Ship Information Handbook		129 / 226
Doc. Reference	23,3 m Trawler		
Doc. Revision & Date	A - 15/09/14		

Code	Warning Category Indicator	SPN-FMI Code	Description	Troubleshooting Procedure	Default
4-6		654-6	Cylinder #4 Injector Current Below Normal	Troubleshooting, "Injector Solenoid - Test"	
5-5		655-5	Cylinder #5 Injector Current Above Normal	Troubleshooting, "Injector Solenoid - Test"	
5-6		655-6	Cylinder #5 Injector Current Below Normal	Troubleshooting, "Injector Solenoid - Test"	
6-5		656-5	Cylinder #6 Injector Current Above Normal	Troubleshooting, "Injector Solenoid - Test"	
6-6		656-6	Cylinder #6 Injector Current Below Normal	Troubleshooting, "Injector Solenoid - Test"	
E015	(2)	110-16	Engine Coolant Temperature Derate	Troubleshooting, "Coolant Temperature is High"	
E017	(1)	110-15	Engine Coolant Temperature Warning	Troubleshooting, "Coolant Temperature is High"	
E025	(2)	172-16	High Inlet Air Temperature Derate	Troubleshooting, "Inlet Air Temperature is High"	
E027	(1)	172-15	High Inlet Air Temperature Warning	Troubleshooting, "Inlet Air Temperature is High"	
E030	(1)	177-15	High Transmission Oil Temperature Warning	Troubleshooting, "Transmission Oil Temperature is High"	
E039	(2)	100-18	Low Engine Oil Pressure Derate	Troubleshooting, "Oil Pressure Is Low"	
41-38		678-3	Volt DC Supply Voltage Above Normal	Troubleshooting, "Sensor Supply - Test"	
41-48		678-4	Volt DC Supply Voltage Above Normal	Troubleshooting, "Sensor Supply - Test"	
E053	(1)	94-17	Low Fuel Pressure Warning	Troubleshooting, "Fuel Pressure Is Low"	
E056	(1)	174-15	High Fuel Temperature Warning	Troubleshooting, "Fuel Pressure Is High"	
E057	(1)	111-18	Low Engine Coolant Level Derate	Troubleshooting, "Coolant Level is Low"	
E059	(1)	111-17	Low Engine Coolant Level Warning	Troubleshooting, "Coolant Level is Low"	
91-8		91-8	Throttle Position Sensor Abnormal Frequency, Pulse Width, or Period	Troubleshooting, "Speed Control - Test"	
91-13		91-13	Throttle Position Sensor Calibration Required	Troubleshooting, "Throttle Position Sensor - Calibrate"	
94-3		94-3	Fuel Delivery Pressure Sensor Voltage Above Normal	Troubleshooting, "Sensor Signal (Analog, Active) - Test"	
94-4		94-4	Fuel Delivery Pressure Sensor Voltage Below Normal	Troubleshooting, "Sensor Signal (Analog, Active) - Test"	
E096	(1)	94-0	High Fuel Pressure	Troubleshooting, "Fuel Pressure Is High"	865 kPa
96-3		96-3	Fuel Level Sensor Voltage Above Normal	Troubleshooting, "Fuel Level - Test"	
96-4		96-4	Fuel Level Sensor Voltage Below Normal	Troubleshooting, "Fuel Level - Test"	
E098	(1)		Engine Pre-lube Override	The keyswitch has been cycled from the ON position to the OFF position back to the ON position in one second or less. The prelube cycle has been overridden.	
E113	(1)	127-15	High Transmission Oil Pressure	Troubleshooting, "Transmission Oil Pressure is High"	
E100	(1)	100-17	Low Engine Oil Pressure Warning	Troubleshooting, "Oil Pressure Is Low"	
100-3		100-3	Engine Oil Pressure Sensor Voltage Above Normal	Troubleshooting, "Sensor Signal (Analog, Active) - Test"	
100-4		100-4	Engine Oil Pressure Sensor Voltage Below Normal	Troubleshooting, "Sensor Signal (Analog, Active) - Test"	
100-10		100-10	Engine Oil Pressure Sensor Abnormal Rate of Change	Troubleshooting, "Sensor Signal (Analog, Active) - Test"	
110-3		110-3	Engine Coolant Temperature Sensor Voltage Above Normal	Troubleshooting, "Sensor Signal (Analog, Passive) - Test"	
110-4		110-4	Engine Coolant Temperature Sensor Voltage Below Normal	Troubleshooting, "Sensor Signal (Analog, Passive) - Test"	
E119	(1)	96-17	Low Fuel Level	Add fuel to the fuel tank. Refer to the literature that is provided by the OEM of the ship for the correct procedure.	
127-3		127-3	Transmission Oil Pressure Sensor Voltage Above Normal	Troubleshooting, "Sensor Signal (Analog, Passive) - Test"	
127-4		127-4	Transmission Oil Pressure Sensor Voltage Below Normal	Troubleshooting, "Sensor Signal (Analog, Passive) - Test"	

Doc. Title	Ship Information Handbook		130 / 226
Doc. Reference	23,3 m Trawler		
Doc. Revision & Date	A - 15/09/14		

Code	Warning Category Indicator	SPN-FMI Code	Description	Troubleshooting Procedure	Default
168-0	(3)	168-0	Electrical System Voltage High	Troubleshooting, "Electrical Power Supply - Test"	
168-1	(3)	168-1	Electrical System Voltage Low	Troubleshooting, "Electrical Power Supply - Test"	
168-2		168-2	Electrical System Voltage Erratic, Intermittent or Incorrect	Troubleshooting, "Electrical Power Supply - Test"	
E172	(1)		High Air Filter Restriction	Troubleshooting, "Inlet Air is restricted"	
E172	(2)		High Air Filter Restriction	Troubleshooting, "Inlet Air is restricted"	
172-3		105-3	Intake Manifold Air Temperature Sensor Voltage Above Normal	Troubleshooting, "Sensor Signal (Analog, Passive) - Test"	
172-4		105-4	Intake Manifold Air Temperature Sensor Voltage Below Normal	Troubleshooting, "Sensor Signal (Analog, Passive) - Test"	
E173	(1)	173-15	High Exhaust Temperature Warning	Troubleshooting, "Exhaust Temperature is High"	
174-3		174-3	Fuel Temperature Sensor Voltage Above Normal	Troubleshooting, "Sensor Signal (Analog, Passive) - Test"	
174-4		174-4	Fuel Temperature Sensor Voltage Below Normal	Troubleshooting, "Sensor Signal (Analog, Passive) - Test"	
177-3		177-3	Transmission Oil Temperature Sensor Voltage Above Normal	Troubleshooting, "Sensor Signal (Analog, Active) - Test"	
177-4		177-4	Transmission Oil Temperature Sensor Voltage Below Normal	Troubleshooting, "Sensor Signal (Analog, Active) - Test"	
190-8		190-8	Engine Speed Sensor Abnormal Frequency, Pulse Width or Period	Troubleshooting, "Speed / Timing - Test"	
E190	(1)		Engine Overspeed Warning	Troubleshooting, "Engine Overspeed"	
E194	(1)		High Exhaust Temperature	Troubleshooting, "Exhaust Temperature is High"	
E233	(1)		Low Engine Pre-Lube Pressure	The oil pressure must be equal to the pressure that is set in the software. If the oil pressure is less than the oil pressure in the software and the prelube timer out, the code will be generated.	
261-11			Engine Timing Offset Fault	Troubleshooting, "Timing Calibrate"	
261-13		228-13	Engine Timing Calibration Required	Troubleshooting, "Timing Calibrate"	
262-35		620-3	Volt Sensor DC Power Supply Voltage Above Normal	Troubleshooting, "Sensor Supply - Test"	
262-45		620-4	Volt Sensor DC Power Supply Voltage Below Normal	Troubleshooting, "Sensor Supply - Test"	
E265	(1)		User Defined Shutdown	Troubleshooting, "Shutdown Test"	
E268	(1)	1383-11	Unexpected Engine Shutdown	Troubleshooting, "Engine Shutdown Occurence"	
268-2		1111-2	Programmed Parameter Fault Erratic, Intermittent or Incorrect	Troubleshooting, "Configuration Parameters"	
342-8		723-8	Secondary Engine Speed Sensor Abnormal Frequency, Pulse Width or Period	Troubleshooting, "Speed / Timing - Test"	
E360	(3)		Low Engine Oil Pressure	Troubleshooting, "Oil Pressure Is Low"	
E361	(2)		High Engine Coolant Temperature	Troubleshooting, "Coolant Temperature is High"	110°C
E361	(3)		High Engine Coolant Temperature	Troubleshooting, "Coolant Temperature is High"	115°C
E362	(2)		Engine Overspeed	Troubleshooting, "Engine Overspeed"	2300 rpm
E362	(3)		Engine Overspeed	Troubleshooting, "Engine Overspeed"	3150 rpm
E363	(1)		High Fuel Supply Temperature	Troubleshooting, "Fuel Temperature is High"	90°C
E390	(1)		Fuel Filter Restriction	Troubleshooting, "Fuel Filter is Restricted"	
535-8		173-08	Exhaust Temperature Sensor Abnormal Frequency, Pulse Width or Period	Troubleshooting, "Sensor Signal (PWM) - Test"	
E540	(1)		Low Engine Oil Refill Tank Level	Troubleshooting, "Oil level - Test"	
E563	(1)		Low Engine Coolant Flow	Troubleshooting, "Coolant Flow - Test"	

Doc. Title	Ship Information Handbook		131 / 226
Doc. Reference	23,3 m Trawler		
Doc. Revision & Date	A - 15/09/14		

Code	Warning Category Indicator	SPN-FMI Code	Description	Troubleshooting Procedure	Default
E1001	(1)		High Right Intake Manifold Air Temperature	Troubleshooting, "Inlet Air Temperature is High"	82°C
E1001	(2)		High Right Intake Manifold Air Temperature	Troubleshooting, "Inlet Air Temperature is High"	86°C
1249-8		59-8	Secondary Throttle Position Signal Abnormal	Troubleshooting, "Speed Control - Test"	
1249-13		29-13	Secondary Throttle Position Calibration Required	Troubleshooting, "Throttle Position Sensor - Calibrate"	
1785-3		102-3	Intake Manifold Pressure Sensor Voltage Below Normal	Troubleshooting, "Sensor Signal (Analog, Active) - Test"	
1785-4		102-4	Intake Manifold Pressure Sensor Voltage Above Normal	Troubleshooting, "Sensor Signal (Analog, Active) - Test"	
1785-10		102-10	Intake Manifold Pressure Sensor Abnormal Rate of Change	Troubleshooting, "Sensor Signal (Analog, Active) - Test"	
E2089	(1)		Oil Renewal Sytem cannot Operate	Troubleshooting, "Oil Renewal - Test"	

Warning Category Indicator	
Category	Severity
(1)	Least Severe
(2)	Moderate Severity
(3)	Most Severe

### 5-3-17. Operating Procedure of Marine Transmission

#### 5-3-17-1. General

The monitoring and control system includes in wheelhouse:

- One Masson Pitch Propeller Remote Control Panel
- One Masson Gearbox Clutching Remote Control Panel
- One Kobelt Bridge Mechanical Control Head (Lever)

The electronic controller provides the interface between the Bridge Mechanical Control Head and the propulsion system, engine, gearbox and propeller.

The central unit of the transmission system processes and executes the clutch request and increase or decrease propeller pitch.

The Bridge Mechanical Control Head is a single mechanical control lever that allows two functions:

- A first detent of the lever engages the propeller clutch (which is always at engine idle)
- A second detent of the lever allows increase the engine speed to achieve the rated engine speed of 1619 rpm.

This engine speed allows to cause the shaft generator to a very close speed of 1500rpm necessary for obtaining the 50Hz frequency (shaft generator 1499.7rpm for engine 1619rpm).

The forward and reverse being ensured by variation of propeller pitch, the Bridge Mechanical Control Head has no "reverse" function.

The variation of the propeller pitch forward or backward is made using a joystick on the Pitch Propeller Remote Control Panel on the left of the Bridge Mechanical Control Head.

This panel includes a display of the pitch and a red indicator light for motor overload.

A second panel, to the right of the Bridge Mechanical Control Head, indicates the permission or not to engage the clutch of the propeller. The permission of clutching is indicated by the blue indicator light.

Doc. Title	Ship Information Handbook		132 / 226
Doc. Reference	23,3 m Trawler		
Doc. Revision & Date	A - 15/09/14		

This clutching panel also includes a red emergency stop push button of the propeller and a red fault indicator light of the gearbox.

### 5-3-17-2. Operating

Before starting, ensure that pre-operational checks on the reverse / reduction gearbox and shafting line are performed, mainly for:

- Oil level for gearbox
- Oil levels for forward and stern tubes of propeller shaft

Ensure that valves of sea water cooling system are correctly operated.

The procedures for starting up the main engine being carried out and the main engine idling speed since a few minutes:

- Bridge Console
  - Make sure you have permission to engage the clutch of propeller shaft (blue indicator light lit on the clutch panel)
    - => If the blue indicator light is not lit, investigate the cause (mechanical lock of the propeller shaft remains in place or clutch selector of gearbox remains in NEUTRAL position)
  - Push the lever of the Mechanical Control Head in the first detent
    - => The gearbox must engage the propeller shaft (the clutching must be engaged between 3 and 6 seconds)
- Engine Room
  - Recheck the gearbox oil level using the dipstick, engine at idling speed.
  - Complete the oil level to the dipstick MAX mark as necessary.
- Bridge Console
  - Wait the complete clutching and push gradually the lever of the Mechanical Control Head thoroughly to reach the nominal engine speed of 1619rpm.

Once this state reached:

- The supply of the network by the shaft generator can be performed
- The control of pitch variation (joystick) is operable; the time required to move from "full ahead" to "full reverse" is of the order of 20-30 seconds.
  - => The increase of propeller pitch must be progressive
  - => Avoid causing an engine overload (red overload indicator light on Pitch Propeller Remote Control Panel)
  - => Check the propeller pitch indicator on the Pitch Propeller Remote Control Panel
  - => A red button on the clutch panel, allows the emergency disengagement of the propeller (eighth trawl, by example)

Doc. Title	Ship Information Handbook		133 / 226
Doc. Reference	23,3 m Trawler		
Doc. Revision & Date	A - 15/09/14		



Figure 5-39 Bridge - Pitch Propeller Remote Control Panel



Figure5-40 Bridge - Gearbox Clutching Remote Control Panel

### 5-3-17-3. Emergency operating of reduction gearbox

In case of failure of the electrical control the engagement and disengagement of the propeller can be done directly by manually acting on the electrically controlled hydraulic distributor (see Masson technical documentation).

- Gear box
  - Disconnect the electric control cable
  - Push the button or screw the knob of the Ahead solenoid distributor into full engagement
  - => The clutch of the propeller should always be at the engine idle speed.

In case of failure of the gear hydraulic system, the clutching of propeller can be done mechanically using "come-home screws" device (see Masson technical documentation)

- Transfer the power supply on Genset
- Stop the propulsion engine
- Bridge Console
  - Disconnect the electric Mechanical Control Head cable to prevent accidental clutching
- Gear box
  - Install the "come-home screws" device as indicated in the technical documentation Masson
  - Start the propulsion engine and sail at very low speed
  - => The lubrication of the gear being reduced, monitor the gearbox oil temperature
  - => At port arrival, remove the device "come-home screws" to prevent damage

Doc. Title	Ship Information Handbook		134 / 226
Doc. Reference	23,3 m Trawler		
Doc. Revision & Date	A - 15/09/14		

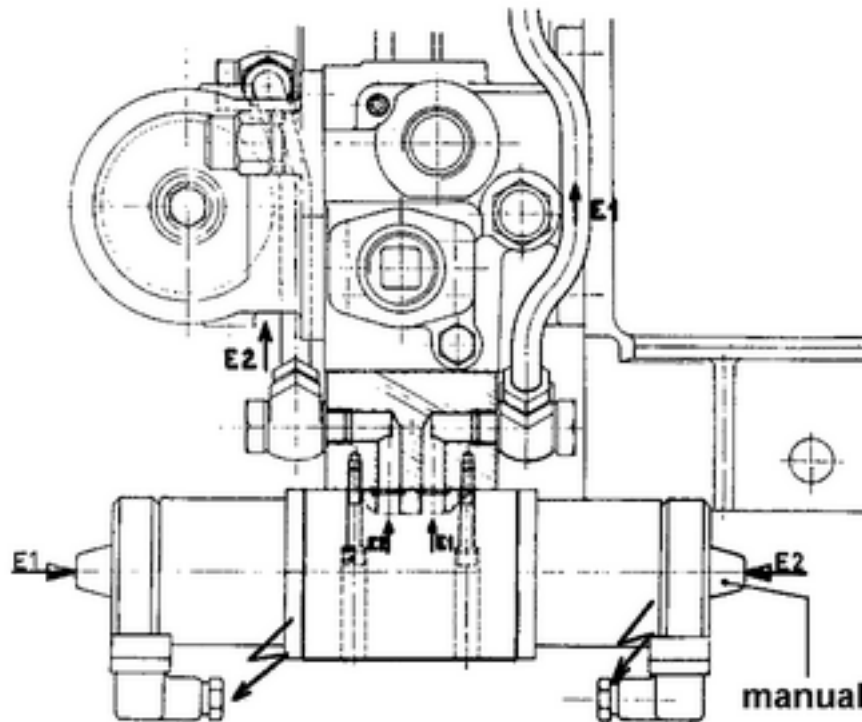

Figure 5-41 Engine Room - Manual Clutching of Propeller Shaft

#### 5-3-17-4. Emergency operating of Controllable Pitch Propeller

In case of failure of the hydraulic system of CPP, the variation of pitch of the propeller can not be carried

In this case, a mechanical locking at maximum pitch is available

- Transfer the power supply on Genset
- Stop the propulsion engine

#### ➤ Propeller Shaft Cylinder

- Use the manual emergency pump and its hose set (Masson P/N 500291)
- Remove A and B plugs from the cylinder
- Connect the hoses to the holes of the propeller shaft cylinder / hydraulic cylinder (connect P mark of the pump to B mark of the cylinder and connect R mark of the pump to A mark of the cylinder)
- Pump in order to achieve the maximum ahead pitch
- Align the holes of the coupling sleeve with the holes of the collar pitch repeater
- Mount and tighten the 4 CHc screws
- Disconnect the hoses and mount the both plugs on shaft cylinder
- Start the propulsion engine, clutch and sail at very low speed
  - => Warning the gearbox does not have reverse, no maneuver up is possible
  - => At port arrival, remove the device to prevent damage

Doc. Title	Ship Information Handbook		135 / 226
Doc. Reference	23,3 m Trawler		
Doc. Revision & Date	A - 15/09/14		

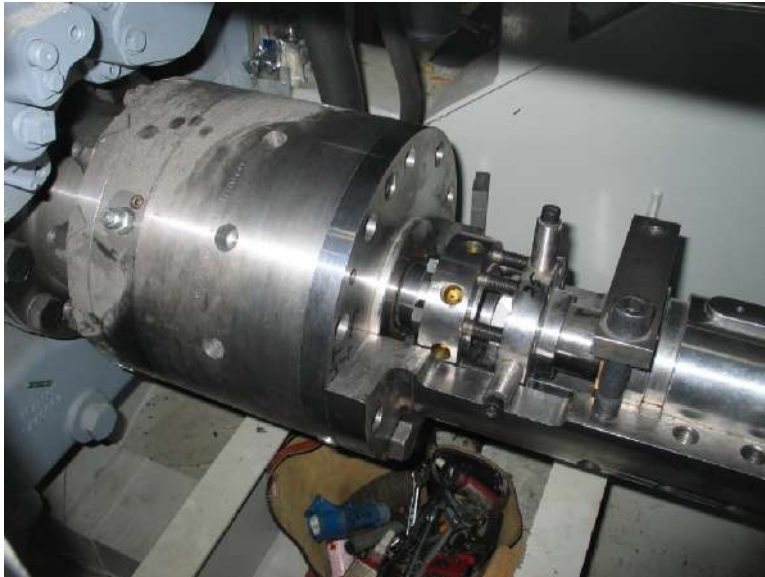

Figure 5-42 Engine Room - Propeller Shaft Cylinder

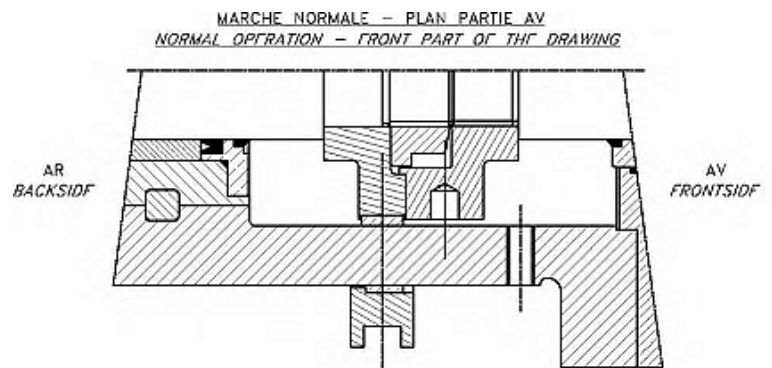
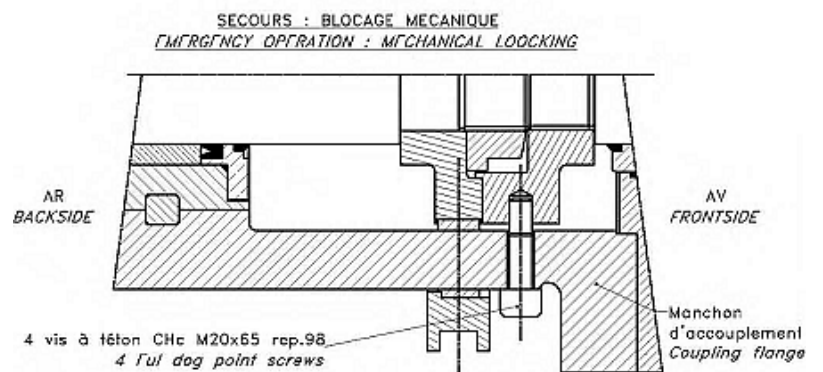



Figure 5-43 Engine Room - Mechanical locking of Propeller Pitch



### 5-3-18. Sea Water Cooling System

The engine and the gensets sea water system valves should be in the open position as indicated in the following table:

Doc. Title	Ship Information Handbook		136 / 226
Doc. Reference	23,3 m Trawler		
Doc. Revision & Date	A - 15/09/14		



VALVE N°	VALVE DESCRIPTION	VALVE LOCATION	VALVE POSITION
MM-0-501	Stbd Sea Chest - Sea Water Cooling Intake (Remote Controlled)	Stbd Engine Room	OPEN
MM-0-502	Port Sea Chest - Sea Water Cooling Intake (Remote Controlled)	Port Engine Room	OPEN
MM-0-505	Stbd Sea Water Cooling Strainer - Outlet	Stbd Engine Room	OPEN
MM-0-506	Port Sea Water Cooling Strainer - Outlet	Port Engine Room	OPEN
MM-0-507	Stbd Sea Chest - Air Vent (Remote Controlled)	Stbd Engine Room	OPEN
MM-0-508	Port Sea Chest - Air Vent (Remote Controlled)	Port Engine Room	OPEN
MM-0-509	Genset Sea Water Cooling - Overboard Discharge	Port Engine Room	OPEN
MM-0-511	Main Engine Sea Water Cooling - Overboard Discharge	Port Engine Room	OPEN
MM-0-513	Main Engine Sea Water Cooling - Suction	Engine Room	OPEN
MM-0-515	Fishing Gear Hydraulic Power Pack Sea Water Cooling - Overboard Discharge	Engine Room	OPEN
MM-0-517	Genset Sea Water Cooling - Suction	Engine Room	OPEN
MM-0-519	Fishing Gear Hydraulic Power Pack Sea water Cooling Pump - Suction	Engine Room	OPEN
MM-0-520	Fishing Gear Hydraulic Power Pack Sea water Cooling Pump - Discharge	Engine Room	OPEN



Figure5-44 Engine Room -Fishing Gear SW Cooling E-Pump



Figure5-45 Engine Room - SW Strainer

Doc. Title	Ship Information Handbook		137 / 226
Doc. Reference	23,3 m Trawler		
Doc. Revision & Date	A - 15/09/14		

**5-3-18-1. Starting of Fishing Gear sea water cooling pump**

- Close the circuit breaker D18 in the Main Switchboard EF-0-001
- => The sea water cooling pump is automatically started when the fishing gear hydraulic pump is clutched

**5-3-19. Operating Procedure of Hydraulic Fishing Gear****5-3-19-1. General**

The Trawler is equipped with the following fishing equipment:

- Two warp winches
- One single and one double net drums, fitted on stern gantry
- One storage drum
- One Gilson winch

Winches and drums are driven by a hydraulic system including the main following equipment:

- One hydraulic pump with 6 independent flows
- One hydraulic 700 liters tank with filtration and oil cooler
- One electrical control box at fishing desk
- One deck control panel

The hydraulic pump is driven by the propulsion plant via a the clutchable PTO of the gear box

When ship is sailing, or when fishing gear is not used, the PTO clutch is not engaged

The control panel, located on the fishing deck, provides simultaneous function of:

- The hydraulic pump by engaging the PTO clutch of the gearbox
- The sea water cooling E-pump MM-0-001

The flow rate of the hydraulic pump is divided into two flows, each feeding a hydraulic control valve:

One feeding:

- The warp winch portside
- The storage drum portside
- The double drum

and another:

- The warp winch stbd
- The Gilson winch
- The single drum

A deck control panel located on the fishing deck controls the operation of various winches and drums

**5-3-19-2. Starting of fishing gear**

The ship is considered sailing, propulsion engine running at its rated speed

Before starting, ensure that pre-operational checks on the hydraulic plant are performed, mainly for:

- Oil level of hydraulic tank
- Correct position of sea water cooling valves
- Electrical control box
  - Push the green "1" button to start the hydraulic pump

Doc. Title	Ship Information Handbook		138 / 226
Doc. Reference	23,3 m Trawler		
Doc. Revision & Date	A - 15/09/14		

- => The gearbox must engage the PTO clutch
- => The sea water cooling E-pump MM-0-001 runs
- Survey indicator lights of low level and high temperature of oil tank
- Deck control panel
  - Each control handle is assigned to a winch or a drum. An action on the joystick in one direction or the other puts the winch drum or moving
  - Each control handle is assigned to a winch or a drum. An action on the joystick in one direction or the other puts the winch drum or moving

### 5.3.19.3 Stopping of fishing gear

Normal stopping of the hydraulic system and cooling pump

- Push the red "0" button to stop the hydraulic pump
- => The gearbox must disengage the PTO clutch
- => The sea water cooling E-pump MM-0-001 stops

Emergency stopping of the hydraulic system and cooling pump

- => This action causes the same effect as normal stopping except that the "punch" button remains engaged

### 5.3.19.4 Emergency operating of fishing gear



Figure5-46 Engine Room - Hydraulic Pump for Fishing Gear

Doc. Title	Ship Information Handbook		139 / 226
Doc. Reference	23,3 m Trawler		
Doc. Revision & Date	A - 15/09/14		



Figure5-47 Fishing Deck - Fishing Gear Electrical Panel



Figure5-48 Fishing Deck - Fishing Gear Deck Control Panel



Doc. Title	Ship Information Handbook		140 / 226
Doc. Reference	23,3 m Trawler		
Doc. Revision & Date	A - 15/09/14		



Figure5-49 Store Room - Fishing Gear Hydraulic Distributor

Doc. Title	Ship Information Handbook		141 / 226
Doc. Reference	23,3 m Trawler		
Doc. Revision & Date	A - 15/09/14		

## CHAPTER 6 – MAINTENANCE SCHEDULE

### 6-1. GENERAL INFORMATION

The content of the maintenance schedule prepared for each equipment or sub-assembly maintainable is precisely described with the following information:

- Reference to the equipment of the SEL with its Ship Index
- A job number for each maintenance task
- A synopsis of each maintenance task
- The periodicity of each task
- The requirements in tools and spare when required
- A link to the Maker's Documentation or to the Ship's Information Handbook when the maintenance instructions are detailed
- An estimating man hours for each
- The number of units fitted onboard

The Maintenance Schedule is presented by discipline.

All equipment of the Ship Equipment List having periodically maintenance operation is listed in this Schedule. When a Ship Index is missing in this Schedule, it means there is no maintenance task on the equipment.

### 6-2. ASSUMPTIONS USED TO ELABORATE THE MAINTENANCE SCHEDULE

This maintenance Schedule is based on the standard maintenance plans, the service manuals of manufacturers and specific practices of the shipyard recommended for this category of ships.

The schedule, at which the maintenance instructions should be carried out, can be expressed on daily, weekly, monthly, yearly and/or on a running hour basis.

In the case of a double frequency (calendar / running hours), the first reached must be taken into consideration.

If the ship or some mechanical equipment (mainly diesel engine) must be subject to extreme operating conditions, the service frequency must be adapted accordingly.

Fluids and lubricants recommended by the OEM are listed in Lubricant Schedule Table § 6-9.

Compliance with these recommendations is essential to ensure a long life to systems and equipment, particularly diesel engines, gear boxes and hydraulic systems.

The recommendation and the first filling were mostly made with genuine products SHELL.

In order to facilitate the supply of lubricants, a correspondence with TOTAL products was made.

Doc. Title	Ship Information Handbook		142 / 226
Doc. Reference	23,3 m Trawler		
Doc. Revision & Date	A - 15/09/14		

### 6-3. FUNCTIONING PRINCIPLE OF MAINTENANCE SCHEDULE TABLE

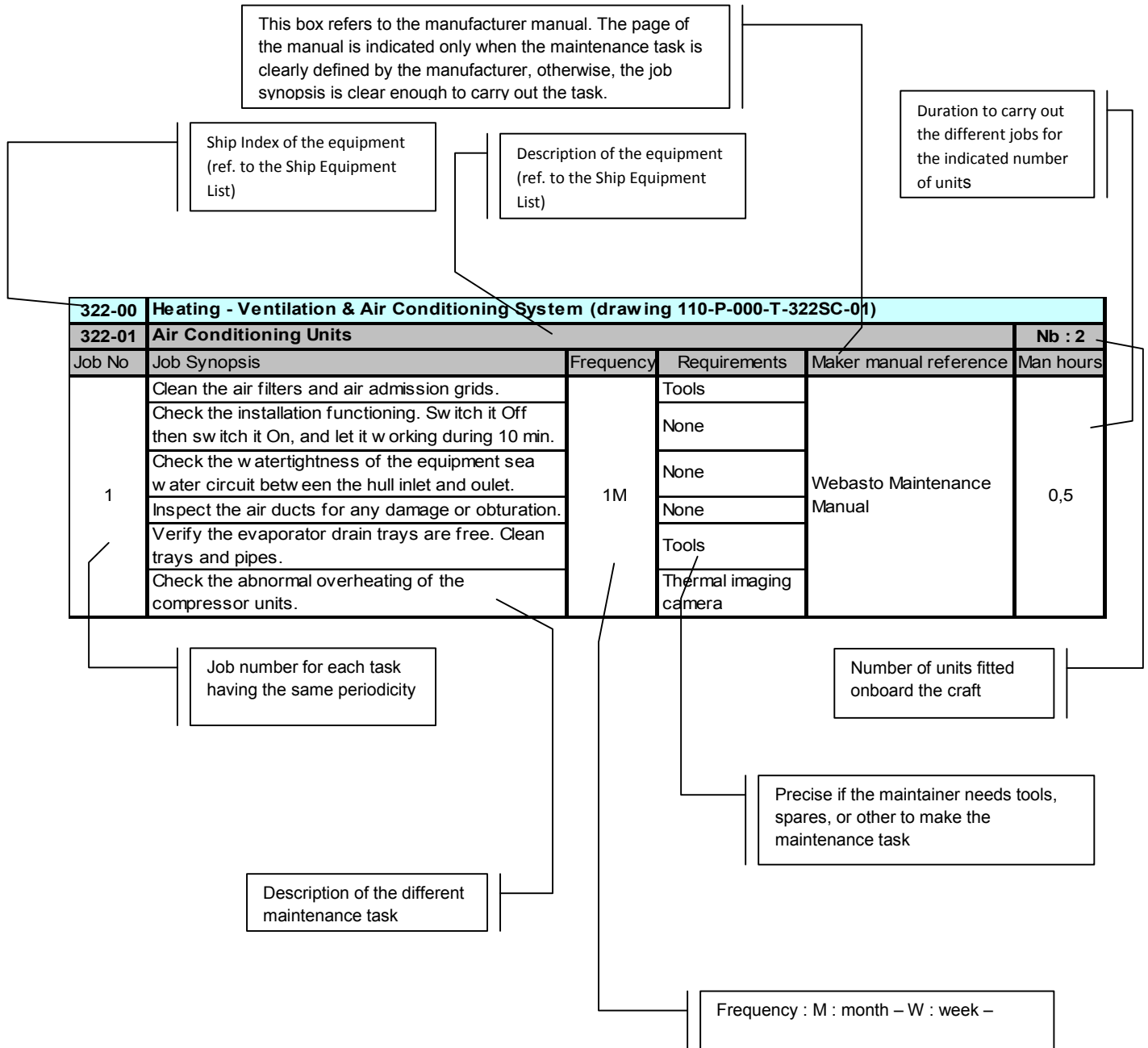

Doc. Title	Ship Information Handbook		143 / 226
Doc. Reference	23,3 m Trawler		
Doc. Revision & Date	A - 15/09/14		

## 6-4. ANCILLARIES OF HULL

210-00 Hull					
210-00 Underwater Hull					Nb : 1
Job No	Job Synopsis	Frequency	Requirements	Maker manual reference	Man hours
1	Examine the general condition of the coating and of any area where deterioration has exposed bare metal. In areas where superficial deterioration of the paint coatings has occurred, remove all loose paint and apply touch up coats of the appropriate paint to restore correct dry film thickness.	3M / At Each Dry Dock Inspection	Respect Paint Scheme	Shipyard recommendation	4
2	Examine structure for mechanical damage, fractures, rust blisters and pitting.	1Y	None	Shipyard recommendation	2
210-01&02 Zinc Anodes - Hull					Nb : 8+6
Job No	Job Synopsis	Frequency	Requirements	Maker manual reference	Man hours
1	Check the 8x1,2kg, the 6x5,9kg and zinc sacrificial anodes and replace it if they have greater than 2/3 wastage.	3M / At Each Dry Dock Inspection	None	DWG 133-F-Z00-S-21000-05 DWG 133-F-M01-P-210MM-01	0,5
210-03 Zinc Anodes - Sea Chests					Nb : 2
Job No	Job Synopsis	Frequency	Requirements	Maker manual reference	Man hours
1	Check the two zinc sacrificial anodes and replace it if they have greater than 2/3 wastage..	3M3M / At Each Dry Dock Inspection	None	DWG 133-F-Z00-S-21000-05 DWG 133-F-M01-P-210MM-01	2

310-00 Main Deck Arrangement					
310-02 Gallow of unloading					Nb : 1
Job No	Job Synopsis	Frequency	Requirements	Maker manual reference	Man hours
1	Inspect the unit for evidence of physical damage/deterioration. Lubricate all grease nipples with Multipurpose Extreme Pressure Water Resistant Grease (NLGI 2).	1M	Grease Gun + Grease	DWG 133-F-P02-X-31000-02	0,25
310-10 Anchoring Line					Nb : 1
Job No	Job Synopsis	Frequency	Requirements	Maker manual reference	Man hours
1	Clean and grease machined surfaces using Multipurpose Extreme Pressure Water Resistant Grease (NLGI 2).	1M	Grease Gun + Grease	Shipyard recommendation	0,25

314-00 Life saving devices					
314-01 Inflatable Liferaft					Nb : 2
Job No	Job Synopsis	Frequency	Requirements	Maker manual reference	Man hours
1	Remove and return the liferaft to the manufacturer or qualified service station for the testing and examination.	1Y	None	Resolution IMO A.761 (18)	1
2	Remove and replace the liferaft.	12Y	None	Resolution IMO A.761 (18)	1

Doc. Title	Ship Information Handbook		144 / 226
Doc. Reference	23,3 m Trawler		
Doc. Revision & Date	A - 15/09/14		



<b>314-02 Inflatable Liferaft Release - Hydrostatic</b>					<b>Nb : 2</b>
Job No	Job Synopsis	Frequency	Requirements	Maker manual reference	Man hours
1	Remove and replace the Hydrostatic release.	2Y	None	Hammar H-20 Manual	0,5

<b>342-00 Tanks</b>					
<b>342-03 Marine Fuel Oil Service Tank</b>					<b>Nb : 1</b>
Job No	Job Synopsis	Frequency	Requirements	Maker manual reference	Man hours
1	External and internal inspection of tank for any signs of deterioration of paint coating, corrosion and damages. Assess and record the amount and nature of sludge and debris prior cleaning the tank.	5Y	None	Shipyard recommendation	8
<b>342-04 Oily Water Tank</b>					<b>Nb : 1</b>
Job No	Job Synopsis	Frequency	Requirements	Maker manual reference	Man hours
1	External and internal inspection of tank for any signs of deterioration of paint coating, corrosion and damages. Assess and record the amount and nature of sludge and debris prior cleaning the tank.	5Y	None	Shipyard recommendation	8
<b>342-05 Fuel Oil Tanks</b>					<b>Nb : 5</b>
Job No	Job Synopsis	Frequency	Requirements	Maker manual reference	Man hours
1	External and internal inspection of tank for any signs of deterioration of paint coating, corrosion and damages. Assess and record the amount and nature of sludge and debris prior cleaning the tank.	5Y	Before entering tank, ensure it's fully ventilated	Shipyard recommendation	48
<b>342-06 Fresh Water Tank</b>					<b>Nb : 1</b>
Job No	Job Synopsis	Frequency	Requirements	Maker manual reference	Man hours
1	External and internal inspection of tank for any signs of deterioration of paint coating, corrosion and damages. Assess and record the amount and nature of sludge and debris prior cleaning the tank.	5Y	None	Shipyard recommendation	8

<b>350 Hatches / Doors &amp; Windows</b>					
Job No	Job Synopsis	Frequency	Requirements	Maker manual reference	Man hours
1	Lubricate hinges sparingly with general purpose grease.	3M	None	Shipyard recommendation	0,5
2	Inspect watertight doors and hatches for any signs of obvious damage.	1Y	None	Shipyard recommendation	1

Doc. Title	Ship Information Handbook		145 / 226
Doc. Reference	23,3 m Trawler		
Doc. Revision & Date	A - 15/09/14		

## 6-5 ELECTRICAL

312-00 Steering Gear					
312-08 Starter Panel					Nb : 1
Job No	Job Synopsis	Frequency	Requirements	Maker manual reference	Man hours
1	Check the terminals of the electric motor. Test the drop of voltage at the terminals.	1Y	Voltmeter	Shipyards recommendation	0,25

322-00 Heating - Ventilation & Air Conditioning System					
322-02 Air Conditioning Unit 4,7 kW					Nb : 2
Job No	Job Synopsis	Frequency	Requirements	Maker manual reference	Man hours
1	Clean the dust filter. Check the free flow of condensates.	1M	None	Webasto Installation & Maintenance Manual	0,25
322-03 Air Conditioning Unit 5,9 kW					Nb : 1
Job No	Job Synopsis	Frequency	Requirements	Maker manual reference	Man hours
1	Clean the dust filter. Check the free flow of condensates.	1M	None	Webasto Installation & Maintenance Manual	0,25

341-00 Fire Detection system					
341-02 Fire Detection Panel					Nb : 1
Job No	Job Synopsis	Frequency	Requirements	Maker manual reference	Man hours
1	Execute functional test of the installation	1W	Gas Detector	Marinelec Fire Detection Manual DI09	0,5
2	Replace internal 3rd source	1Y	None	Marinelec Fire Detection Manual DI09	1
341-03 Heat/Smoke Detector					Nb : 2
Job No	Job Synopsis	Frequency	Requirements	Maker manual reference	Man hours
1	Replace detector	10Y	None	Marinelec Fire Detection Manual DI09	2

365-00 Galley					
365-04 Hood					Nb : 1
Job No	Job Synopsis	Frequency	Requirements	Maker manual reference	Man hours
1	Clean the grease filter	1M	None	Faure Technical Data Sheet	0,25

410-00 AC 400V - 50Hz Electrical Network					
410-01 Main Electrical Switchboard					Nb : 1
Job No	Job Synopsis	Frequency	Requirements	Maker manual reference	Man hours
1	Inspect, remove dust and test Main Switchboard. Clean or replace Air Filter. Check the fastening screws, nuts, and retighten if necessary.	6M	Portable Vacuum Cleaner Electrical Toll Box	SA2EI Electrical Switchboards Technical Manual	1

Doc. Title	Ship Information Handbook		146 / 226
Doc. Reference	23,3 m Trawler		
Doc. Revision & Date	A - 15/09/14		

410-02 Distribution Panel AC230V Machinery Room					Nb : 1
Job No	Job Synopsis	Frequency	Requirements	Maker manual reference	Man hours
1	Inspect and remove dust. Check the fastening screws, nuts, and retighten if necessary.	6M	Portable Vacuum Cleaner Electrical Toll Box	SA2EI Electrical Switchboards Technical Manual	0,5

410-03 Distribution Frame AC230V Wheelhouse					Nb : 1
Job No	Job Synopsis	Frequency	Requirements	Maker manual reference	Man hours
1	Inspect and remove dust. Check the fastening screws, nuts, and retighten if necessary.	6M	Portable Vacuum Cleaner Electrical Toll Box	SA2EI Electrical Switchboards Technical Manual	0,5

410-04 Distribution Panel AC230V Workshop					Nb : 1
Job No	Job Synopsis	Frequency	Requirements	Maker manual reference	Man hours
1	Inspect and remove dust. Check the fastening screws, nuts, and retighten if necessary.	6M	Portable Vacuum Cleaner Electrical Toll Box	SA2EI Electrical Switchboards Technical Manual	0,5

412-00 Generators					
412-03 Alternator Leroy Somer LSAM 43.2 S25					Nb : 1
Job No	Job Synopsis	Frequency	Requirements	Maker manual reference	Man hours
1	Check and retight all electric connections as required.	3M	Common tools	Shipyard recommendation	0,5

412-06 Alternator PTO Driven Leroy Somer ECP34-1/L4 MECCALTE					Nb : 1
Job No	Job Synopsis	Frequency	Requirements	Maker manual reference	Man hours
1	Check and retight all electric connections as required.	3M	Common tools	Shipyard recommendation	0,5

420-00 DC 24V Electrical Network					
420-01 Battery Charger - AC230V/DC24V 60A					Nb : 1
Job No	Job Synopsis	Frequency	Requirements	Maker manual reference	Man hours
1	Clean inside of the equipment with a vacuum cleaner; the build-up of dust prevents heat dissipation.	3M	Portable Vacuum Cleaner	Enag User Manual CDS3 Battery Charger	0,25
2	Full inspection, check the tightness of all electrical connections	1Y	Common tools		0,5

420-02 GMDSS Power Supply Box					Nb : 1
Job No	Job Synopsis	Frequency	Requirements	Maker manual reference	Man hours
1	Clean inside of the equipment with a vacuum cleaner; the build-up of dust prevents heat dissipation.	3M	Portable Vacuum Cleaner	Enag GMDSS Power Supply Box Manual July 1st 2009	0,5
2	Full inspection, check the tightness of all electrical connections	1Y	Common tools		1
3	Replace the electronic capacitors	10Y	Common tools		2

420-03 Gel Battery 12V 165Ah					Nb : 2
Job No	Job Synopsis	Frequency	Requirements	Maker manual reference	Man hours
1	Clean the batteries and cables	3M	None	Shipyard recommendation	0,25
2	Check the battery cable terminal fastening and retighten if necessary	6M	Tools		0,25

Doc. Title	Ship Information Handbook		147 / 226
Doc. Reference	23,3 m Trawler		
Doc. Revision & Date	A - 15/09/14		

420-04 Distribution Frame DC24V Wheelhouse					Nb : 1
Job No	Job Synopsis	Frequency	Requirements	Maker manual reference	Man hours
1	Inspect and remove dust. Check the fastening screws, nuts, and retighten if necessary.	6M	Portable Vacuum Cleaner Electrical Toll Box	SA2EI Electrical Switchboards Technical Manual	0,5

577-00 Propulsion & Gensets Remote Control & Monitoring Systems					
577-06 AGM Battery 12V 320Ah					Nb : 2
Job No	Job Synopsis	Frequency	Requirements	Maker manual reference	Man hours
1	Clean the batteries and cables	3M	None	Shipyards recommendation	0,25
2	Check the battery cable terminal fastening and retighten if necessary	6M	Tools		0,25
577-07 AGM Battery 12V 110Ah					Nb : 2
Job No	Job Synopsis	Frequency	Requirements	Maker manual reference	Man hours
1	Clean the batteries and cables	3M	None	Shipyards recommendation	0,25
2	Check the battery cable terminal fastening and retighten if necessary	6M	Tools		0,25

630-00 Navigation System					
630-45 Gel Battery 12V 90Ah					Nb : 2
Job No	Job Synopsis	Frequency	Requirements	Maker manual reference	Man hours
1	Clean the batteries and cables	3M	None	Shipyards recommendation	0,25
2	Check the battery cable terminal fastening and retighten if necessary	6M	Tools		0,25

Doc. Title	Ship Information Handbook		148 / 226
Doc. Reference	23,3 m Trawler		
Doc. Revision & Date	A - 15/09/14		

## 6-6. MECHANICAL

<b>310-00 Main Deck Arrangement</b>					
<b>310-03 Electric Winch 500 kg</b>					<b>Nb : 1</b>
Job No	Job Synopsis	Frequency	Requirements	Maker manual reference	Man hours
1	Check wire rope visually.	D	None	Huchet Electric Winches Technical Manual	0,1
2	Clean and grease wire rope. Check fastening points of hook.	1M	Lubricant Fluid acc. Lubricant Table.	Huchet Electric Winches Technical Manual	0,5
3	Renew grease bath of gear box.	100H / 3Y	EP Grease	Huchet Electric Winches Technical Manual	2

<b>312-00 Steering Gear</b>					
Job No	Job Synopsis	Frequency	Requirements	Maker manual reference	Man hours
1	Visually inspect all system flexible hoses. Check specifically for any sign of cracking, brittleness, leaking, fretting, cuts, tears or abraded areas, deformations of the outer skin.	6M	None	Shipyards recommendation	0,5
2	Replace all flexible hoses.	5Y	None	Shipyards recommendation	2
<b>312-01 Steering Unit (articulations of cylinders)</b>					<b>Nb : 1</b>
Job No	Job Synopsis	Frequency	Requirements	Maker manual reference	Man hours
1	Lubricate all grease nipples with Multipurpose Extreme Pressure Water Resistant Grease.	50H/1W	Grease Gun + Grease	Fluidmeccanica Instruction Manual LBI 003053	0,25
<b>312-02 Oil Tank, Double with Emergency Manual Pump</b>					<b>Nb : 1</b>
Job No	Job Synopsis	Frequency	Requirements	Maker manual reference	Man hours
1	Check hydraulic oil level	1W	None	Fluidmeccanica Instruction Manual LBI 003053	0,25
2	Drain and change the hydraulic oil using ISO VG-46 Hydraulic Oil & the filter element.	1Y	Hydraulic Oil + Filter cartridge		2
<b>312-10 Rudder Stock</b>					<b>Nb : 1</b>
Job No	Job Synopsis	Frequency	Requirements	Maker manual reference	Man hours
1	Lubricate Lower Bearing and Rudder Tube grease nipples with Multipurpose Extreme Pressure Water Resistant Grease (NLGI 2).	50H/1W	Grease Gun + Grease	Fluidmeccanica Instruction Manual LBI 003053	0,25
2	Lubricate Pintle Housing grease nipple with Multipurpose Extreme Pressure Water Resistant Grease.	At each dry dock inspection	Grease Gun + Grease	Fluidmeccanica Instruction Manual LBI 003053	0,25

Doc. Title	Ship Information Handbook		149 / 226
Doc. Reference	23,3 m Trawler		
Doc. Revision & Date	A - 15/09/14		

<b>322-00 Heating - Ventilation &amp; Air Conditioning System</b>					
<b>322-01 Fan Unit, Helicoïd - Air Exhaust</b>					<b>Nb : 2</b>
Job No	Job Synopsis	Frequency	Requirements	Maker manual reference	Man hours
1	Clean the machine by blowing with dry compressed air	1Y	Dry compressed air	Enag Maintenance Guide 20097DAA	0,5
<b>322-02 Air Conditioning Units</b>					<b>Nb : 3</b>
Job No	Job Synopsis	Frequency	Requirements	Maker manual reference	Man hours
1	Clean the air filters and air admission grids. Check the watertightness of the equipment sea water circuit between the hull inlet and outlet. Inspect the air ducts for any damage or obturation. Check condensed-water drainage from the condensate tray and condensed-water drain line for clear passage and leakage.	1M	None	Webasto Maintenance Manual	1
2	Check and retight if necessary all bolts, mounts, etc... Check the tightness of the refrigerant circuit for any leakage.	1Y	Thermal imaging camera Gas detector	Shipyards recommendation	1

<b>324-00 AC Sea Water Cooling System</b>					
Job No	Job Synopsis	Frequency	Requirements	Maker manual reference	Man hours
1	Check the flow of sea water to the discharge overboard when ACU is running.	1W	None	Webasto Installation & Maintenance Manual	0,25
2	Check the zinc sacrificial anodes and replace it if they have greater than 50% wastage.	1M	None	Shipyards recommendation	1
3	Check the zinc sacrificial anodes and replace it if they have greater than 50% wastage.	3M	None	Shipyards recommendation	1

<b>331-00 Fresh Water System</b>					
Job No	Job Synopsis	Frequency	Requirements	Maker manual reference	Man hours
1	Visually inspect all system flexible hoses. Check specifically for any sign of cracking, brittleness, leaking, fretting, cuts, tears or abraded areas, deformations of the outer skin.	6M	None	Shipyards recommendation	0,25
2	Replace all flexible hoses.	5Y	None	Shipyards recommendation	1
<b>331-03 Basket Filter DN40</b>					<b>Nb : 2</b>
Job No	Job Synopsis	Frequency	Requirements	Maker manual reference	Man hours
1	Clean the strainer	3M	Common tools	Shipyards recommendation	0,5
<b>331-04 Basket Filter DN25</b>					<b>Nb : 1</b>
Job No	Job Synopsis	Frequency	Requirements	Maker manual reference	Man hours
1	Clean the strainer	3M	Common tools	Shipyards recommendation	0,25

Doc. Title	Ship Information Handbook		150 / 226
Doc. Reference	23,3 m Trawler		
Doc. Revision & Date	A - 15/09/14		

<b>332-00 Firemain System</b>					
Job No	Job Synopsis	Frequency	Requirements	Maker manual reference	Man hours
1	Operate all seawater valves to assure they are operating and prevent the deposition of sediment.	1M	None	Shipyards recommendation	1
2	Check the zinc sacrificial anodes and replace it if they have greater than 50% wastage.	3M	none	Shipyards recommendation	1
3	Visually inspect all system flexible hoses. Check specifically for any sign of cracking, brittleness, leaking, fretting, cuts, tears or abraded areas, deformations of the outer skin.	6M	None	Shipyards recommendation	0,5
4	Replace all flexible hoses.	5Y	None	Shipyards recommendation	2

<b>333-00 Bilge System</b>					
Job No	Job Synopsis	Frequency	Requirements	Maker manual reference	Man hours
1	Operate all seawater valves to assure they are operating and prevent the deposition of sediment.	1M	None	Shipyards recommendation	1
2	Check the zinc sacrificial anodes and replace it if they have greater than 50% wastage.	3M	None	Shipyards recommendation	1
3	Visually inspect all system flexible hoses. Check specifically for any sign of cracking, brittleness, leaking, fretting, cuts, tears or abraded areas, deformations of the outer skin.	6M	None	Shipyards recommendation	0,5
4	Replace all flexible hoses.	5Y	None	Shipyards recommendation	2
<b>333-04 Mud Box DN50</b>					<b>Nb : 2</b>
Job No	Job Synopsis	Frequency	Requirements	Maker manual reference	Man hours
1	Clean the strainer	6M	Common tools	Shipyards recommendation	0,5
<b>333-05 Mud Box DN65</b>					<b>Nb : 1</b>
Job No	Job Synopsis	Frequency	Requirements	Maker manual reference	Man hours
1	Clean the strainer	6M	Common tools	Shipyards recommendation	0,25
<b>333-06 Mud Box DN80</b>					<b>Nb : 1</b>
Job No	Job Synopsis	Frequency	Requirements	Maker manual reference	Man hours
1	Clean the strainer	6M	Common tools	Shipyards recommendation	0,25

<b>335-00 Marine Fuel Oil System</b>					
1	Visually inspect all system flexible hoses. Check specifically for any sign of cracking, brittleness, leaking, fretting, cuts, tears or abraded areas, deformations of the outer skin.	6M	None	Shipyards recommendation	0,25
2	Replace all flexible hoses.	5Y	None	Shipyards recommendation	1

Doc. Title	Ship Information Handbook		151 / 226
Doc. Reference	23,3 m Trawler		
Doc. Revision & Date	A - 15/09/14		

<b>335-01 Centrifugal Water Separator Unit 760l/h</b>					<b>Nb : 1</b>
Job No	Job Synopsis	Frequency	Requirements	Maker manual reference	Man hours
1	Cleaning of bowl	72H Max.	Special tools	Alfa Laval separator manual 9001834-02 Rev.2	1
2	Replace the O-rings with new ones included in the O-ring service kit. Check the condition of discs in the bowl, replace if necessary.	1Y	Special tools	Alfa Laval separator manual 9001834-02 Rev.2	1
3	Check/replace the disc stack to maintain the separation efficiency. Fit new vibration dampers. Inspect the stop flanges of the dampers for possible damage and replace the stop flanges with new ones if necessary.	2Y	Special tools	Alfa Laval separator manual 9001834-02 Rev.2	2
<b>335-05 Fuel Oil/Water Static Duplex Separator</b>					<b>Nb : 1</b>
Job No	Job Synopsis	Frequency	Requirements	Maker manual reference	Man hours
1	Inspect or drain collection bowl of water and contaminants.	1D	Spare	Parker Racor Instructions Ref. 19536	0,25
2	Replace the fuel filter element.	500H (ME) or 6M	Spare	Parker Racor Instructions Ref. 19536	0,25
<b>335-06 Basket Filter DN50</b>					<b>Nb : 1</b>
Job No	Job Synopsis	Frequency	Requirements	Maker manual reference	Man hours
1	Clean the strainer	6M	Common tools	Shipyards recommendation	0,25
<b>335-07 Basket Filter DN20</b>					<b>Nb : 1</b>
Job No	Job Synopsis	Frequency	Requirements	Maker manual reference	Man hours
1	Clean the strainer	6M	Common tools	Shipyards recommendation	0,25
<b>335-08 Basket Filter DN65</b>					<b>Nb : 1</b>
Job No	Job Synopsis	Frequency	Requirements	Maker manual reference	Man hours
1	Clean the strainer	6M	Common tools	Shipyards recommendation	0,25
<b>335-09 Hydraulic Pump Unit Station, Double for Quick Closing Valves</b>					<b>Nb : 1</b>
Job No	Job Synopsis	Frequency	Requirements	Maker manual reference	Man hours
1	Test the closing actuation of engine room fuel oil supply valves. After test, reset opening the valves into the machinery room.	2M	None	Shipyards recommendation	0,5
2	Drain and change the hydraulic oil using ISO VG-15 Hydraulic Oil.	As Request	Use hydraulic oil acc. lubricant schedule		1

<b>336-00 Lub Oil System</b>					
<b>336-02 Basket Filter DN40</b>				<b>Nb : 1</b>	
Job No	Job Synopsis	Frequency	Requirements	Maker manual reference	Man hours
1	Clean the strainer	6M	Common tools	Shipyards recommendation	0,25

Doc. Title	Ship Information Handbook		152 / 226
Doc. Reference	23,3 m Trawler		
Doc. Revision & Date	A - 15/09/14		



<b>338-00 Air Vents, Sounding &amp; Overflow</b>					
<b>338-01 Aseptic Filter</b>					<b>Nb : 3</b>
Job No	Job Synopsis	Frequency	Requirements	Maker manual reference	Man hours
1	Replace the air filter element.	5Y	Common tools	Shipyard recommendation	0,5

<b>341-10 CO2 Extinguishing system</b>					
<b>341-11 Cylinder 50 litre with 33kg CO2 Charge</b>					<b>Nb : 2</b>
Job No	Job Synopsis	Frequency	Requirements	Maker manual reference	Man hours
1	Ensure that the CO2 pressure gauge indicates 0 bar in closed CO2 manifold Check that system components are undamaged.	1M	None	Shipyard recommendation	0,25
2	Ensure that the Load of CO2 is correct.	3M	Use a paint burner to heat the self-adhesive strip during one minute or use an ultrasonic level indicator.	Shipyard recommendation	0,25

<b>368-00 Refrigeration Plant for Fish Hold</b>					
<b>368-01 Fish Hold Chiller - Compressor</b>					<b>Nb : 1</b>
Job No	Job Synopsis	Frequency	Requirements	Maker manual reference	Man hours
1	Visual check of refrigeration plant for oil leaks. Check the Oil Levels.	1W	None	FAI Technical Manual for Fish Hold Refrigerating Plant	0,25
2	Check the moisture with viewfinder indicator on liquid line. Check for refrigerant leaks using an automatic halogen leak detector.	1M	Automatic halogen leak detector	FAI Technical Manual for Fish Hold Refrigerating Plant	0,25
3	Check the trip and reclosing points of the safety devices.	3M	None	FAI Technical Manual for Fish Hold Refrigerating Plant	1
4	Check the good condition of crankcase heaters. Check the absence of deterioration due to the vibrations.	1Y	None	FAI Technical Manual for Fish Hold Refrigerating Plant	1
<b>368-02 Fish Hold Chiller - Condenser</b>					<b>Nb : 1</b>
Job No	Job Synopsis	Frequency	Requirements	Maker manual reference	Man hours
1	Check for refrigerant leaks using an automatic halogen leak detector.	1W	Automatic halogen leak detector	FAI Technical Manual for Fish Hold Refrigerating Plant	0,25
2	Inspect and clean condenser.	6M	Boiler tube brush	FAI Technical Manual for Fish Hold Refrigerating Plant	2
<b>368-05 Ice Generator - Compressor</b>					<b>Nb : 1</b>
Job No	Job Synopsis	Frequency	Requirements	Maker manual reference	Man hours
1	Visual check of refrigeration plant for oil leaks. Check the Oil Levels.	1W	None	FAI Technical Manual for Fish Hold Refrigerating Plant	0,25

Doc. Title	Ship Information Handbook		153 / 226
Doc. Reference	23,3 m Trawler		
Doc. Revision & Date	A - 15/09/14		

2	Check the moisture with viewfinder indicator on liquid line. Check for refrigerant leaks using an automatic halogen leak detector.	1M	Automatic halogen leak detector	FAI Technical Manual for Fish Hold Refrigerating Plant	0,25
3	Check the trip and reclosing points of the safety devices.	3M	None	FAI Technical Manual for Fish Hold Refrigerating Plant	1
4	Check the good condition of crankcase heaters. Check the absence of deterioration due to the vibrations.	1Y	None	FAI Technical Manual for Fish Hold Refrigerating Plant	1
5	Renew compressor oil. Clean also filter and magnetic plug. Check the cut out points of safety pressure switches HP/LP	Initial 100H 3Y / 12000H	Only by skilled refrigeration personnel. Attention; Ester oils are strongly hygroscopic.	FAI Technical Manual for Fish Hold Refrigerating Plant	2
<b>368-06</b>	<b>Ice Generator - Condenser</b>				<b>Nb : 1</b>
Job No	Job Synopsis	Frequency	Requirements	Maker manual reference	Man hours
1	Check for refrigerant leaks using an automatic halogen leak detector.	1W	Automatic halogen leak detector	FAI Technical Manual for Fish Hold Refrigerating Plant	0,25
2	Clean condensate drain.	1Y	None	FAI Technical Manual for Fish Hold Refrigerating Plant	0,5
<b>368-09</b>	<b>Fish Hold &amp; Ice Generator - Electrical Control Cabinet</b>				<b>Nb : 1</b>
Job No	Job Synopsis	Frequency	Requirements	Maker manual reference	Man hours
1	Clean for dust. Check connectors tightening	1Y	Vacuum Cleaner	FAI Technical Manual for Fish Hold Refrigerating Plant	0,25
<b>368-13</b>	<b>Ice Generator</b>				<b>Nb : 1</b>
Job No	Job Synopsis	Frequency	Requirements	Maker manual reference	Man hours
1	Clean filter & water spray. Manipule the ball valve.	W	None	Geneglance F100M Maintenance Manual	0,25
2	Clean salt dozer	M	None	Geneglance F100M Maintenance Manual	0,5
3	Check condition of torque limiter and wipers. Lubricate central shaft bearing with Multipurpose Extreme Pressure Water Resistant Grease (NLGI 2).	3M	Grease gun	Geneglance F100M Maintenance Manual	0,5
4	Check the tension of the belt. Check and retight all electric connections as required.	6M	Common tools	Geneglance F100M Maintenance Manual	0,5
5	Clean sea water condenser	1Y	Common tools	Geneglance F100M Maintenance Manual	1
6	Replace ball valve, central shaft bearing, wipers, carbon brushes of water pump motor, reamer and its bearings.	3Y	Common tools	Geneglance F100M Maintenance Manual	1

Doc. Title	Ship Information Handbook		154 / 226
Doc. Reference	23,3 m Trawler		
Doc. Revision & Date	A - 15/09/14		

412-00 Generator Set					
412-02 Diesel Engine Caterpillar C4.4 (Naturally Aspirated Marine Genset)					Nb : 1
Job No	Job Synopsis	Frequency	Requirements	Maker manual reference	Man hours
1	Belt - Inspect / Adjust / Replace Coolant Level - Check Electrical Connections - Check Engine Air Cleaner Service Indicator - Inspect Engine Oil Level - Check Walk-Around Inspection	Day	None	Caterpillar Operation and Maintenance Manual C4.4 (Mech) Marine Genset MCS-3	0,5
2	Automatic Start / Stop - Inspect	W	None	Caterpillar Operation and Maintenance Manual C4.4 (Mech) Marine Genset MCS-3	0,25
3/1	Coolant sample (Level 2) - Obtain (for analysis).	Initial 500H	None	Caterpillar Operation and Maintenance Manual C4.4 (Mech) Marine Genset MCS-3	0,25
3/2	Auxiliary Water Pump - Inspect Engine Air Cleaner Element (Dual Element) - Inspect / Clean / Replace Engine Mounts - Inspect Engine Oil Sample - Obtain Engine Oil and Filter - Change Fuel System Primary Filter (Water Separator) Element - Replace Fuel System Secondary Filter - Replace Fuel Tank Water and Sediment - Drain Heat Exchanger - Inspect / Clean Hoses and Clamps - Inspect / Replace	500H 1Y 4150 Fuel Liters	Use lub. Oil acc. Lubricant schedule	Caterpillar Operation and Maintenance Manual C4.4 (Mech) Marine Genset MCS-3	8
4	Engine speed / Timing sensor - Cleaning / Inspect	1000H	Common Tools	Caterpillar Operation and Maintenance Manual C4.4 (Mech) Marine Genset MCS-3	0,5
5/1	Battery charger - Check	1000H 1Y	None	Caterpillar Operation and Maintenance Manual C4.4 (Mech) Marine Genset MCS-3	0,5
5/2	Engine Valve Lash - Check	1000H 1Y 8300 Fuel Liters	Only qualified personnel should perform this maintenance	Caterpillar Operation and Maintenance Manual C4.4 (Mech) Marine Genset MCS-3	2
6	Coolant sample (Level 2) - Obtain (for analysis).	1Y	None	Caterpillar Operation and Maintenance Manual C4.4 (Mech) Marine Genset MCS-3	0,25
7	Alternator - Inspect. Coolant Temperature Regulator - Replace. Generator - Inspect. Generator Set Vibration - Inspect. Rotating Rectifier - Check Starting Motor - Inspect. Water Pump - Inspect	2000H 2Y 16600 Fuel Liters	Common Tools	Caterpillar Operation and Maintenance Manual C4.4 (Mech) Marine Genset MCS-3	2

Doc. Title	Ship Information Handbook		155 / 226
Doc. Reference	23,3 m Trawler		
Doc. Revision & Date	A - 15/09/14		

8	Engine protection devices - Check	3000H 3Y	Common Tools	Caterpillar Operation and Maintenance Manual C4.4 (Mech) Marine Genset MCS-3	1
9	Extended Life Coolant (ELC) - Adding	6000H 3Y	Use Coolant acc. Lubricant schedule	Caterpillar Operation and Maintenance Manual C4.4 (Mech) Marine Genset MCS-3	0,5
10	Engine Crankcase Breather - Replace	8000H	Common Tools	Caterpillar Operation and Maintenance Manual C4.4 (Mech) Marine Genset MCS-3	1
11	Coolant (ELC) - Change	8000H	Common Tools	Caterpillar Operation and Maintenance Manual C4.4 (Mech) Marine Genset MCS-3	1
12	Overhaul Considerations	12000H	Common Tools	Caterpillar Operation and Maintenance Manual C4.4 (Mech) Marine Genset MCS-3	NA

541-00 Propulsion Plant					
541-01 Main Propulsion Diesel Engine Caterpillar C32 ACERT Phase 3 - Rating A					Nb : 1
Job No	Job Synopsis	Frequency	Requirements	Maker manual reference	Man hours
1	After cooler condensate drain valve - Inspect /Clean Engine cooling system corrosion protection system - Inspect. Sea water strainer - Clean / Inspect.	50H 1W	Common Tools Multimeter	Caterpillar Operation and Maintenance Manual C32 Marine Engine	0,5
2	Belts - Inspect / adjust / Replace. Engine Oil Sample - Obtain. Fuel tank water and sediment - Drain. Hoses and clamps - Inspect / Replace.	250H	Common Tools	Caterpillar Operation and Maintenance Manual C32 Marine Engine	0,5
3	Engine valve lash - Check. Engine valve rotators - Inspect. Fuel injector - Check	Initial 500H	Only qualified personnel should perform this maintenance	Caterpillar Operation and Maintenance Manual C32 Marine Engine	8
4	Coolant sample (Level 2) for analysis - Obtain. Engine crankcase breather - Clean. Fuel system primary filter (water separator) element - Replace. Fuel system secondary filter - Replace.	500H 1Y	Fuel filter elements	Caterpillar Operation and Maintenance Manual C32 Marine Engine	2
5	After cooler core - Inspect. Heat exchanger - Inspect.	Initial 1000H	Common Tools	Caterpillar Operation and Maintenance Manual C32 Marine Engine	2
6	Engine Oil and Filter - Change Engine air cleaner element (Single element) - Inspect / Replace. Turbocharger - Inspect.	1000H	Use lub. Oil acc. Lubricant Schedule	Caterpillar Operation and Maintenance Manual C32 Marine Engine	4
7	Fumes disposal filter element - Replace.	2000H	Common Tools	Caterpillar Operation and Maintenance Manual C32 Marine Engine	0,5
8/1	Bolts (Fuel filter base) - Inspect / Replace. Coolant temperature regulator - Replace. Crankshaft vibration damper - Inspect. Engine mounts - Inspect. Engine speed / Timing sensor - Clean / Inspect. Starting motor - Inspect.	3000H	Common Tools	Caterpillar Operation and Maintenance Manual C32 Marine Engine	8

Doc. Title	Ship Information Handbook		156 / 226
Doc. Reference	23,3 m Trawler		
Doc. Revision & Date	A - 15/09/14		

8/2	Engine valve lash - Check. Engine valve rotators - Inspect. Fuel injector - Check.	3000H	Only qualified personnel should perform this maintenance	Caterpillar Operation and Maintenance Manual C32 Marine Engine	8
8/3	Auxiliary water pump (Bronze impeller) - Inspect / Replace.	3000H /170.000 Fuel Liters	Common Tools	Caterpillar Operation and Maintenance Manual C32 Marine Engine	2
9	Water pump - Inspect	5000H	Common Tools	Caterpillar Operation and Maintenance Manual C32 Marine Engine	4
10	Aftercooler core - Inspect. Heat exchanger - Clean / Test. Oil cooler core - Check / Clean / Test. Top end overhaul considerations.	Refer to Caterpillar Operation and Maintenance Manual C32 Marine Engine - Page 102 Maintenance Recommendations			
11	Aftercooler core - Inspect. Heat exchanger - Clean / Test. Overhaul considerations.	Refer to Caterpillar Operation and Maintenance Manual C32 Marine Engine - Page 102 Maintenance Recommendations			
<b>541B02</b>	<b>Reduction Gear Box Masson MM-W-3900-NR-CEW</b>				<b>Nb : 1</b>
Job No	Job Synopsis	Frequency	Requirements	Maker manual reference	Man hours
1	Check oil level.	100H	At Engine idle Speed	Masson W3900 Operating Instructions	0,25
2	Change oil and filter element.	Initial 100H	Common Tools	Masson W3900 Operating Instructions	1
3	Clean Oil Filter. Clean Oil Cooler.	500H	Boiler tube brush	Masson W3900 Operating Instructions	2
4	Change oil and filter element.	2500H 1Y	Common Tools	Masson W3900 Operating Instructions	2
5	Replace the PTO-Clutch elastic spider (Fishing Gear HP Pump)	6000H	Common Tools	Masson W3900 Operating Instructions	4
6	Visual gear inspection.	8000H	Common Tools	Masson W3900 Operating Instructions	4
7	Replace hydraulic accumulator Replace oil cooler tube nest Replace clutch control solenoid	15000H	Common Tools	Masson W3900 Operating Instructions	8
8	Replace oil pump, suction and pressure hoses. Replace clutch discs and seals. Replace input shaft bearings, clutch and drive pinion bearings.	25000H	Only qualified personnel should perform this maintenance	Masson W3900 Operating Instructions	tbd
9	Replace oil pump, suction and pressure hoses. Replace clutch discs and seals. Replace input shaft bearings, clutch and drive pinion bearings. Replace output shaft bearings.	40000H	Only qualified personnel should perform this maintenance	Masson W3900 Operating Instructions	tbd

Doc. Title	Ship Information Handbook		157 / 226
Doc. Reference	23,3 m Trawler		
Doc. Revision & Date	A - 15/09/14		

<b>572B00 Shafting Line and Controlled Pitch Propeller (CPP)</b>					
<b>572B02 Bulkhead Seal</b>					<b>Nb : 1</b>
Job No	Job Synopsis	Frequency	Requirements	Maker manual reference	Man hours
1	Inspection of the seal	5Y / after activation	None	Profiseal Installation and Operation Instructions	2
<b>572B04 Earthing Assy</b>					<b>Nb : 1</b>
Job No	Job Synopsis	Frequency	Requirements	Maker manual reference	Man hours
1	Check the cleanliness of the slipping face and the correct compression of the hold-down springs of the brushes. Check the wear of the brushes.	1W	None	Shipyards recommendations	0,25
<b>572A06 Propeller</b>					<b>Nb : 1</b>
Job No	Job Synopsis	Frequency	Requirements	Maker manual reference	Man hours
1	Inspect all sacrificial anodes for wastage; if more than 50% wastage has occurred renew the anodes.	6M	None	Shipyards recommendations	2
<b>572A07 Stern Tube assy</b>					<b>Nb : 1</b>
Job No	Job Synopsis	Frequency	Requirements	Maker manual reference	Man hours
1	Take and record wear of stern tube bearings as required by classification society.	5Y	None	Masson MMS480 CPP Operating Instructions	tbd
<b>572A09 Fwd Stern Tube Seals</b>					<b>Nb : 1</b>
Job No	Job Synopsis	Frequency	Requirements	Maker manual reference	Man hours
1	Inspect visually the Fwd seal for signs of leakage.	1D	None	Masson MMS480 CPP Operating Instructions	0,25
<b>572A10 Hydraulic Block of Pitch Control</b>					<b>Nb : 1</b>
Job No	Job Synopsis	Frequency	Requirements	Maker manual reference	Man hours
4	Change oil filter element (fitted on the reduction gearbox). The oil of CPP being derived from the reduction gearbox, it is recommended to carry out maintenance of the gearbox and the CPP at the same time.	1Y	Common Tools	Masson MMS480 CPP Operating Instructions	2
<b>572A12 Stern tube lub oil tank &amp; Fwd shaft seal lub oil tanks</b>					<b>Nb : 1</b>
Job No	Job Synopsis	Frequency	Requirements	Maker manual reference	Man hours
1	Check the stern tube lub oil tank level (Workshop). Check the Fwd shaft seal lub oil tank level (Storage Room). Check and record the bearing / stern tube oil temperature. Check the temperature of Fwd seal lub oil.	1D	None	Masson MMS480 CPP Operating Instructions	0,5
2	Test the lub oil of stern tube and Fwd shaft seal in accordance with classification society and replace it if necessary.	1Y	Common Tools	Shipyards recommendations	2
3	Inspect the stern tube and Fwd shaft seals, replace it as request.	5Y	None	Profiseal Installation and Operation Instructions	tbd

Doc. Title	Ship Information Handbook		158 / 226
Doc. Reference	23,3 m Trawler		
Doc. Revision & Date	A - 15/09/14		

<b>575-00 Sea Water Cooling System</b>					
Job No	Job Synopsis	Frequency	Requirements	Maker manual reference	Man hours
1	Operate all seawater valves to assure they are operating and prevent the deposition of sediment.	1M	None	Shipyard recommendation	1
2	Check the zinc sacrificial anodes and replace it if they have greater than 50% wastage.	3M	None	Shipyard recommendation	1
3	Visually inspect all system flexible hoses. Check specifically for any sign of cracking, brittleness, leaking, fretting, cuts, tears or abraded areas, deformations of the outer skin.	6M	None	Shipyard recommendation	0,5
4	Replace all flexible hoses.	5Y	None	Shipyard recommendation	2
<b>575-01 Sea Water Strainer DN125</b>					<b>Nb : 2</b>
Job No	Job Synopsis	Frequency	Requirements	Maker manual reference	Man hours
1	Clean / inspect the port & stbd strainers	1W	Common tools	Shipyard recommendation	0,5

<b>900B00 Fishing Equipment</b>					
<b>900B01 Oil Tank Equipped</b>					<b>Nb : 1</b>
Job No	Job Synopsis	Frequency	Requirements	Maker manual reference	Man hours
1	Replace oil filter element	Initial 50H	None	Bopp Trawler Equipment Instruction Manual	0,5
2	Replace oil filter element	Initial 250H	None	Bopp Trawler Equipment Instruction Manual	0,5
3	Replace oil filter element	Initial 500H	None	Bopp Trawler Equipment Instruction Manual	0,5
4	Replace oil filter element	500H	None	Bopp Trawler Equipment Instruction Manual	0,5
5	Clean Oil Cooler.	6M	Boiler tube brush	Bopp Trawler Equipment Instruction Manual	2
6	Take an oil sample to analysis.	1Y	None	Bopp Trawler Equipment Instruction Manual	0,5
7	Renew oil charge and clean hydraulic tank.	In case of exceeding cleanliness	Cleanliness class 7/8 (NAS 1638) or class 18/15/13 (ISO 4406)	Bopp Trawler Equipment Instruction Manual	4
<b>900B03 Hydraulic System</b>					<b>Nb : 1</b>
Job No	Job Synopsis	Frequency	Requirements	Maker manual reference	Man hours
1	Check of all connections, clamps and hydraulic components subject to vibrations. Check of flexible pipes for oxydation or cracks).	6M	None	Bopp Trawler Equipment Instruction Manual	2
2	Check the good condition of sensors, pressure controllers and hydraulic valves.	6M	None	Bopp Trawler Equipment Instruction Manual	2
<b>900B05 Deck Control Panel</b>					<b>Nb : 1</b>
Job No	Job Synopsis	Frequency	Requirements	Maker manual reference	Man hours
1	Check the performance and characteristics of winches and drums (Speed, progressiveness, etc...).	1Y	None	Bopp Trawler Equipment Instruction Manual	2

Doc. Title	Ship Information Handbook		159 / 226
Doc. Reference	23,3 m Trawler		
Doc. Revision & Date	A - 15/09/14		

<b>900B06 Warp Winches</b>					<b>Nb : 1</b>
Job No	Job Synopsis	Frequency	Requirements	Maker manual reference	Man hours
1	Lubricate grease nipples with Multipurpose Extreme Pressure Water Resistant Grease.	50H/1W	Grease Gun + Grease	Bopp Trawler Equipment Instruction Manual	0,25
2	Renew lub oil of shaft housing and drive mechanism of the control screw	1Y	Oil in accordance w. Lubrication Schedule	Bopp Trawler Equipment Instruction Manual	2
<b>900B07 Dual and single Net Drums on Gantry</b>					<b>Nb : 1</b>
Job No	Job Synopsis	Frequency	Requirements	Maker manual reference	Man hours
1	Lubricate grease nipples with Multipurpose Extreme Pressure Water Resistant Grease.	50H/1W	Grease Gun + Grease	Bopp Trawler Equipment Instruction Manual	0,25
<b>900B09 Single Net Drum on Deck</b>					<b>Nb : 1</b>
Job No	Job Synopsis	Frequency	Requirements	Maker manual reference	Man hours
1	Lubricate grease nipples with Multipurpose Extreme Pressure Water Resistant Grease.	50H/1W	Grease Gun + Grease	Bopp Trawler Equipment Instruction Manual	0,25
<b>900B10 Gilson Winch</b>					<b>Nb : 1</b>
Job No	Job Synopsis	Frequency	Requirements	Maker manual reference	Man hours
1	Renew oil for preservation of grooves.	As request	Oil in accordance w. Lubrication Schedule	Bopp Trawler Equipment Instruction Manual	1
<b>900B16 Fish Conveyor</b>					<b>Nb : 1</b>
Job No	Job Synopsis	Frequency	Requirements	Maker manual reference	Man hours
1	Check general condition and tension of modular belt. Clean as necessary.	1W	None	Benne Fish Conveyor Instruction Manual	0.25
2	Visual inspection of worm gear E-motor. Check oil level of worm gearbox. Check good condition and grease ball bearings.	1M	Grease Gun + Grease	Benne Fish Conveyor Instruction Manual	0.5
3	Change lubricating oil of worm gearbox.	1Y/3000H	Oil in accordance w. Lubrication Schedule	Benne Fish Conveyor Instruction Manual	2

Doc. Title	Ship Information Handbook		160 / 226
Doc. Reference	23,3 m Trawler		
Doc. Revision & Date	A - 15/09/14		



## 6-7. COMMUNICATION & NAVIGATION

620-00 External Communication System					
620-01 VHF/IMM Radiotelephone					Nb : 1
Job No	Job Synopsis	Frequency	Requirements	Maker manual reference	Man hours
1	Execute functional Daily test.	Day	None	Furuno FM8900S VHF Radiotelephone Operator's Manual	0,25
2	Check antenna for physical damage and corrosion. remove dust from the cabinet. Check cables for tightly fastened, corrosion and rust.	1M	None	Furuno FM8900S VHF Radiotelephone Operator's Manual	0,5
620-04 VHF/IMM Radiotelephone - Antenna					Nb : 1
Job No	Job Synopsis	Frequency	Requirements	Maker manual reference	Man hours
1	Inspect antenna for any damage. Check the fastenings of antenna base. Remove contamination using cleaning cloth and fresh water.	1M	None	Shipyards recommendation	0,25
2	Check all cables and connections for chaffing, damage and corrosion. Retighten connections if necessary.	1Y	None	Shipyards recommendation	0,25
620-05 VHF Marine Radiotelephone					Nb : 1
Job No	Job Synopsis	Frequency	Requirements	Maker manual reference	Man hours
1	Check cables for tightly fastened, corrosion and rust. Wipe the LCD carefully to prevent scratching.	1M	None	Furuno FM4721 VHF Radiotelephone Operator's Manual	0,25
620-07 VHF Marine Radiotelephone - Antenna					Nb : 1
Job No	Job Synopsis	Frequency	Requirements	Maker manual reference	Man hours
1	Inspect antenna for any damage. Check the fastenings of antenna base. Remove contamination using cleaning cloth and fresh water.	1M	None	Shipyards recommendation	0,25
2	Check all cables and connections for chaffing, damage and corrosion. Retighten connections if necessary.	1Y	None	Shipyards recommendation	0,25
620-08 HF/MF BLU Radiotelephone					Nb : 1
Job No	Job Synopsis	Frequency	Requirements	Maker manual reference	Man hours
1	Inspect and perform a functional test.	Day	None	Furuno SSB Radiotelephone Operator's Manual	0,5
620-10 HF/MF BLU Radiotelephone - Antenna					Nb : 1
Job No	Job Synopsis	Frequency	Requirements	Maker manual reference	Man hours
1	Inspect antenna for any damage. Check the fastenings of antenna base. Remove contamination using cleaning cloth and fresh water.	1M	None	Shipyards recommendation	0,25
2	Check all cables and connections for chaffing, damage and corrosion. Retighten connections if necessary.	1Y	None	Shipyards recommendation	0,25

Doc. Title	Ship Information Handbook		161 / 226
Doc. Reference	23,3 m Trawler		
Doc. Revision & Date	A - 15/09/14		

<b>620-14 Navtex Receiver</b>					<b>Nb : 1</b>
Job No	Job Synopsis	Frequency	Requirements	Maker manual reference	Man hours
1	Check connectors for tightened and ground terminal for tightened and free of rust. Wipe the LCD carefully to prevent scratching.	1M	None	Furuno Navtex Receiver Operator's Manual	0,25
<b>620-20 VHF GMDSS Handheld Radiotelephone</b>					<b>Nb : 1</b>
Job No	Job Synopsis	Frequency	Requirements	Maker manual reference	Man hours
1	Inspect, perform a functional test. Clean any grime or salt residue off the unit. Confirm the battery is within the specified expiry date.	1M	None	Ocean Signal Safesea V100 User Manual	0,5
2	Replace the battery	Before expiry date	None	Ocean Signal Safesea V100 User Manual	0,25
<b>620-21 EPIRB</b>					<b>Nb : 1</b>
Job No	Job Synopsis	Frequency	Requirements	Maker manual reference	Man hours
1	Inspect and perform a functional test. Confirm the battery is within the specified expiry date.	1M	None	Ocean Signal EPIRB User Manual	0,25
2	Replace the battery	5Y	None	Ocean Signal EPIRB User Manual	0,25
<b>620-22 Search And Rescue Transponder (SART)</b>					<b>Nb : 1</b>
Job No	Job Synopsis	Frequency	Requirements	Maker manual reference	Man hours
1	Inspect, perform a functional test. Clean any grime or salt residue off the unit. Check correct SART operation using the test mode. Confirm the battery is within the specified expiry date.	1M	None	Ocean Signal SART User Manual	0,5
2	Replace the battery	Before expiry date	None	Ocean Signal SART User Manual	0,25
<b>630-00 Navigation System</b>					
<b>630-01 Color LCD Sounder</b>					<b>Nb : 1</b>
Job No	Job Synopsis	Frequency	Requirements	Maker manual reference	Man hours
1	Check cable of transducer for damage. Check power cable of transducer for tightened. Check display unit ground for corrosion. Check voltage of power supply.	1M	None	Simrad Color LCD Sounder Operator's Manual	0,5
<b>630-03 Transducer 38/200khz</b>					<b>Nb : 1</b>
Job No	Job Synopsis	Frequency	Requirements	Maker manual reference	Man hours
1	Perform a thorough visual check of the transducer. If necessary clean the transducer using synthetic soap and water. Remove marine growth using fine-grade sand paper or emery paper.	At Each Dry Dock Inspection	Do not use strong solvent or high pressure water	Simrad Color ES70 Operator's Manual	0,5
<b>630-05 Transducer 50khz</b>					<b>Nb : 1</b>
Job No	Job Synopsis	Frequency	Requirements	Maker manual reference	Man hours
1	Perform a thorough visual check of the transducer. If necessary clean the transducer using synthetic soap and water. Remove marine growth using fine-grade sand paper or emery paper.	At Each Dry Dock Inspection	Do not use strong solvent or high pressure water	Furuno FCV1150 Operator's Manual	0,5

Doc. Title	Ship Information Handbook		162 / 226
Doc. Reference	23,3 m Trawler		
Doc. Revision & Date	A - 15/09/14		

<b>630-06 Transducer 38khz</b>					<b>Nb : 1</b>
Job No	Job Synopsis	Frequency	Requirements	Maker manual reference	Man hours
1	Perform a thorough visual check of the transducer. If necessary clean the transducer using synthetic soap and water. Remove marine growth using fine-grade sand paper or emery paper.	At Each Dry Dock Inspection	Do not use strong solvent or high pressure water	Furuno FCV1150 Operator's Manual	0,5
<b>630-10 VHF/ADDF Antenna</b>					<b>Nb : 1</b>
Job No	Job Synopsis	Frequency	Requirements	Maker manual reference	Man hours
1	Inspect antenna for any damage. Check the fastenings of antenna base. Remove contamination using cleaning cloth and fresh water.	1M	None	Shipyard recommendation	0,25
2	Check all cables and connections for chaffing, damage and corrosion. Retighten connections if necessary.	1Y	None	Shipyard recommendation	0,25
<b>630-11 X Band Marine Radar 4kW 36Nm</b>					<b>Nb : 1</b>
Job No	Job Synopsis	Frequency	Requirements	Maker manual reference	Man hours
1	Check connectors for tightened and ground terminal for tightened and free of rust. Check exposed nuts and bolts on antenna unit for free of rust and loosened. Check antenna radiator for dirt and cracks.	3M	None	Furuno Maine Radar Operator's Manual	0,5
<b>630-13 X Band Marine Radar 6kW 48Nm</b>					<b>Nb : 1</b>
Job No	Job Synopsis	Frequency	Requirements	Maker manual reference	Man hours
1	Check connectors for tightened and ground terminal for tightened and free of rust. Check exposed nuts and bolts on antenna unit for free of rust and loosened. Check antenna radiator for dirt and cracks.	3M	None	Furuno Maine Radar Operator's Manual	0,5
<b>630-15 Satellite Compass</b>					<b>Nb : 1</b>
Job No	Job Synopsis	Frequency	Requirements	Maker manual reference	Man hours
1	Check connectors for tightened and ground terminal for tightened and free of rust. Check ground terminal for rust. Check the antenna cable for water leakage. Remove dust and dirt from display and processor unit.	1M	None	Furuno Satellite Compass Operator's Manual	0,5
<b>630-17 Satellite Compass - GPS Antenna</b>					<b>Nb : 1</b>
Job No	Job Synopsis	Frequency	Requirements	Maker manual reference	Man hours
1	Inspect antenna for any damage. Check the fastenings of antenna base. Remove contamination using cleaning cloth and fresh water.	1M	None	Shipyard recommendation	0,25
2	Check all cables and connections for chaffing, damage and corrosion. Retighten connections if necessary.	1Y	None	Shipyard recommendation	0,25
<b>630-18 GPS Display</b>					<b>Nb : 1</b>
Job No	Job Synopsis	Frequency	Requirements	Maker manual reference	Man hours
1	Check connectors for tightened and ground terminal for tightened and free of rust. Check the antenna cable for water leakage. Remove dust and dirt from the cabinet. Wipe the LCD carefully to prevent scratching.	1M	None	Furuno Remote Display Operator's Manual	0,5

Doc. Title	Ship Information Handbook		163 / 226
Doc. Reference	23,3 m Trawler		
Doc. Revision & Date	A - 15/09/14		

<b>630-20 GPS Navigator</b>					<b>Nb : 1</b>
Job No	Job Synopsis	Frequency	Requirements	Maker manual reference	Man hours
1	Check connectors for tightened and ground terminal for tightened and free of rust. Check battery terminal for rust. Remove dust and dirt from cabinet. Wipe the LCD carefully to prevent scratching.	1M	None	Furuno GPS Navigator Operator's Manual	0,25
<b>630-29 Autopilot</b>					<b>Nb : 1</b>
Job No	Job Synopsis	Frequency	Requirements	Maker manual reference	Man hours
1	Clean the display unit. Check the connectors.	1M	None	Simrad Autopilot Operator's Manual	0,25

Doc. Title	Ship Information Handbook		164 / 226
Doc. Reference	23,3 m Trawler		
Doc. Revision & Date	A - 15/09/14		

## 6-8. LUBRICANT SCHEDULE

Equipment	Manufacturer	Capacity Litres	Product Generic Description	Initial Replenishment		TOTAL Equivalence	Standards	CMN Art.
				Manufact.	Brand Name			
Main Engine C32	Caterpillar	138	4-Stroke ULSD Diesel Engine Multi-Grade Heavy Duty, Low SAPS Technology, Mineral Blend Oil SAE 15W-40	Shell	Rimula R4L 15W-40	Rubia TIR 7900 15W-40	API CJ-4, CI-4, CF-4, CH-4, CG-4 Euro III, Euro IV, Euro V Cat ECF-2, ECF-3	9150000227 (20Li Drum) 9150000237 (Bulk)
Genset C4.4 DINA	Caterpillar	9						
Main Engine C32	Caterpillar	118	Extended Life Coolant (ELC)	Caterpillar	Cat ELC	NA	Cat EC-1	
Genset C4.4 DINA	Caterpillar	18						
Reduction Gear Box MM-W-3900-NR-CEW + Hydraulic System of Controllable Pitch Propeller	Masson	75 (2)	4-Stroke Diesel Engine Mono-Grade Heavy Duty Mineral Blend Oil SAE 30	Shell	Rimula R3(+) 30 (Previous Name Rimula X30)	Rubia S-30	API CF Euro II	
Stern Tube (CPP) Tank	Masson	NG						
Fwd Shaft Seal (CPP) Tank	Masson	NG						
Fishing Winches Hydraulic Power Pack	Bopp	700 (1)	High Performance Mineral Hydraulic & Lubricating Oil ISO (3448) VG-46 HVLP	Shell	Tellus S2 V46 (Previous Name Tellus T46)	Equivis ZS 46	DIN 51524 Part 3 HVLP 46	9150000129 (Bulk)
Steering Gear Power Pack	Fluidmeccanica	74 (1)						
Pump Unit Station, Double for Quick Closing Valves	Aquiro	NSQ	High Performance Mineral Hydraulic & Lubricating Oil ISO (3448) VG-15 HVLP	Shell	Tellus S2 V15 (Previous Name Tellus T15)	Equivis ZS 15	DIN 51524 Part 3 HVLP 15	9150000228 (Bulk)
Fish Hold Reciprocating Compressor 4EES-4Y	Bitzer	NG	Refrigerating Machine Ester Lubricating Oil ISO 32 of Reciprocating Compressors	Bitzer	BSE-32			
Ice Generator Reciprocating Compressor 6CES-6Y-40S	Bitzer	NG						
Fish Hold Refrigerating Plant	Bitzer	NG	Unchlorinated Gas Refrigerant	Atofina	Forane R404A	NA	NA	
Ice Generator - Reduction Gear	Geneglance	NG	High Performance Synthetic Gear Lubricating Oil ISO 220	Shell	Tivela WB			

Doc. Title	Ship Information Handbook		165 / 226
Doc. Reference	23,3 m Trawler		
Doc. Revision & Date	A - 15/09/14		

Equipment	Manufacturer	Capacity Litres	Product Generic Description	Initial Replenishment		TOTAL Equivalence	Standards	CMN Art.
				Manufact.	Brand Name			
Gilson Winch TCH-18-MF-HYDRO	Bopp	NSQ	Extreme Pressure Mineral Gear Lubrication Oil ISO (3448) VG-320	Shell	Omala S2 G-320 (Previous Name Omala 320)	Carter EP 320	DIN 51517 Part 3 CLP 320	9150000172 (Bulk)
Warp Winch TS 10-35-20-1B HYDRO	Bopp	26,5x2						
Electric Winch 500kg - Wire Rope	Huchez	NSQ	Lubricant biodegradable for wire ropes.	Shell	Lurop V	NA		
Electric Winch 500kg - Wire Rope	Huchez	NSQ	Solvent for Lurop V lubricant	Shell	Solvent SM	NA		
Fishing Winches	Bopp	NSQ	Extreme Pressure Lithium Soap based Grease NLGI-2	Shell	Alvania EP-2	Multis EP-2		9150000215 (Cartridge)
Rudder Stock	Fluidmeccanica	NSQ						
Reduction Gear Box MM-W-3900-NR-CEW	Masson	NSQ						
Electric Winch 500kg	Huchez	NSQ						
Fish Convoyer - Ball Bearings	Benne	NSQ						
Fish Convoyer - Worm Gearbox SA57DRE90L4	Benne	0,5	Extreme Pressure Mineral Gear Lubrication Oil ISO (3448) VG-220	Shell	Omala S2 G-220 (Previous Name Omala 220)	Carter EP 220	DIN 51517 Part 3 CLP 220	
Ice Generator - Vertical Salt Doser	Geneglance	35 (3)	Salt Tablet (Sodium Chloride) - Dia. 25mmxThick 16mm	Axal	Pro Salt Tablet			

NA : Not Applicable

NG : Not Given

NSQ : No Significant Quantity

Notes:

**Mark with (1) indicates only the volume of tank. The volume of oil used for fill the piping system is not included.**

**Mark with (2) indicates only the volume of gearbox sump. The add volume of oil used for controllable pitch propeller is not included.**

**Mark with (2) indicates approximatively the salt tablets capacity of the vertical doser.**

Doc. Title	Ship Information Handbook		166 / 226
Doc. Reference	23,3 m Trawler		
Doc. Revision & Date	A - 15/09/14		

## 6-9. COMMERCIAL LUBRICANTS DATA SHEETS

### 6-9-1. Shell Rimula R4 L 15W-40 Diesel Engine Oil



#### Technical Data Sheet

## Shell Rimula R4 L 15W-40 (CJ-4)

- Low Emissions
- Extra Life - Improved Protection

### Multigrade Heavy Duty Diesel Engine Oils

Shell Rimula R4 L Energised Protection oils use the latest "Low-SAPS" additive technology to protect under the most severe conditions found in modern low emission engines. The protective power of the oil is enhanced through the use of high purity "Group II" base oils that provide increased additive activity. It delivers significant improvements in wear protection, deposit control and resistance to breakdown under high temperatures\*.

The exclusive low-ash formulation helps protect the exhaust catalysts and particulate traps found on the latest low emission vehicles. Recommended by a wide range of OEMs, suitable for both the latest low-emissions (Euro 4,5, US 2007) and older model equipment.

\* compared to previous generation oils such as API CI-4 and ACEA E7



**ENERGISED PROTECTION**  
Adapting to your engine's changing needs

#### Performance, Features & Benefits

##### • Simplify inventory needs

Shell Rimula R4 L is approved by a wide range of leading OEMs, simplifying inventory needs for fleets with a mixture of engine makes:

##### • Emissions system capability

Advanced low-ash formulation helps control blocking of or poisoning of exhaust after-treatment devices, helping maintain vehicle emission compliance and engine fuel efficiency.

##### • Lower operating costs

Shell Rimula R4 L is formulated with an enhanced acid-control system to help fleet operators to achieve maximum drain flexibility.

##### • Outstanding wear protection

Demonstrated over millions of km of customer service, Shell Rimula R4 L provides significantly higher levels of wear protection than previous generation oils to prolong engine efficiency and life.

##### • Off-highway applications

Suitable for use in agricultural and construction applications, even with high levels of fuel sulphur.

#### Specifications, Approvals & Recommendations

- Caterpillar: ECF-2, ECF-3
- Cummins: CES 20081, 77, 72, 71
- DDC: 93K218
- Deutz: DOC III-10 LA
- MACK: EO-O Premium Plus
- MAN: 3575
- MB Approval: 228.31
- MTU: Category 2.1
- Renault Trucks: RLD-3
- Scania: Low Ash
- JASO: DH-2
- IVECO: T2 E7 (Meets specification)
- Volvo: VDS-4, VDS-3
- API: CJ-4, CI-4+, CI-4, CH-4, CG-4, CF-4, CF.
- ACEA: E9, E7

For a full listing of equipment approvals and recommendations, please consult your local Shell Technical Helpdesk, or the OEM Approvals website.

#### Main Applications



##### • Severe duty heavy duty diesel engines

Shell Rimula R4 L is our highest performance 15W-40 HD oil providing outstanding protection for virtually all engines including the latest Euro 5 and US 2007 as well as older units.

Doc. Title	Ship Information Handbook		167 / 226
Doc. Reference	23,3 m Trawler		
Doc. Revision & Date	A - 15/09/14		

## Typical Physical Characteristics

Properties			Method	Shell Rimula R4 L 15W-40 (CJ-4)
<b>Viscosity Grade</b>				15W-40
<b>Kinematic Viscosity</b>	@40°C	mm <sup>2</sup> /s	ASTM D445	118
<b>Kinematic Viscosity</b>	@100°C	mm <sup>2</sup> /s	ASTM D445	15.5
<b>Viscosity Index</b>			ASTM D2270	139
<b>Density</b>	@15°C	kg/l	ASTM D4052	0.883
<b>Sulphated Ash</b>			ASTM D874	1.0 max
<b>Total Base Number</b>			ASTM D2896	10.6
<b>Flash Point (COC)</b>			ASTM D92	227
<b>Pour Point</b>			ASTM D97	-33

These characteristics are typical of current production. Whilst future production will conform to Shell's specification, variations in these characteristics may occur.

## Health, Safety &amp; Environment

- **Health and Safety**

Shell Rimula R4 L 15W-40 (CJ-4) is unlikely to present any significant health or safety hazard when properly used in the recommended application and good standards of personal hygiene are maintained.

Avoid contact with skin. Use impervious gloves with used oil. After skin contact, wash immediately with soap and water.

Guidance on Health and Safety is available on the appropriate Material Safety Data Sheet, which can be obtained from <http://www.epc.shell.com/>

- **Protect the Environment**

Take used oil to an authorised collection point. Do not discharge into drains, soil or water.

## Additional Information

- **Advice**

Advice on applications not covered here may be obtained from your Shell representative.

Doc. Title	Ship Information Handbook		168 / 226
Doc. Reference	23,3 m Trawler		
Doc. Revision & Date	A - 15/09/14		



## 6-9-2. Shell Rimula R3+ 30 Diesel Engine Oil



Technical Data Sheet

### Shell Rimula R3+ 30 (CF/228.0)

• Extra Performance Monograde

Monograde Heavy Duty Diesel Engine Oils

Shell Rimula R3 Energised Protection oils feature proven lubricant chemistry that adapts to your driving needs to provide extra protection whatever the demands of your engine or equipment. Featuring an active-detergent system to keep pistons and other engine parts clean, it provides protection against wear for long engine life and protection against deposits for efficient engine performance.



#### Performance, Features & Benefits

##### • Equipment manufacturer acceptance

Shell Rimula R3 monogrades are approved for use in a variety of engine applications by leading OEMs.

##### • High standard of piston cleanliness

The high thermal stability and oil oxidation resistance provide a high standard of piston cleanliness.

##### • Low engine wear and long component life

Overall engine cleanliness contributes to low engine wear, long component life, maintenance of power output, more operational stability and lower servicing costs.

#### Main Applications



##### • Dedicated diesel engine oil performance

Shell Rimula R3 monogrades have been formulated to provide robust engine performance in a variety of off-highway applications or older on-highway diesel vehicles.

##### • Construction Industry application

Engine oil technology is sometimes specified for use in the transmission and hydraulic applications. Shell Rimula R3 monogrades offer premium performance and protection for these applications.

##### • Stationary equipment

Shell Rimula R3 monogrades are suitable for certain stationary equipment, such as pumps, that run continuously under steady state conditions.

##### • Detroit Diesel two-stroke engines

Shell Rimula R3 oils should not be used in Detroit Diesel two-stroke engines. An SAE 40 oil meeting the API CF-II Specification and having a sulphated ash content of less than 1% should be used.

#### Specifications, Approvals & Recommendations

- MAN : 270
- MB Approval: 228.0
- MTU: Category 1
- API : CF

For a full listing of equipment approvals and recommendations, please consult your local Shell Technical Helpdesk, or the OEM Approvals website.

Doc. Title	Ship Information Handbook		169 / 226
Doc. Reference	23,3 m Trawler		
Doc. Revision & Date	A - 15/09/14		

## Typical Physical Characteristics

Properties			Method	Shell Rimula R3+ (CF/228.0)
Viscosity Grade				30
Kinematic Viscosity	@40°C	mm <sup>2</sup> /s	ASTM D 445	93
Kinematic Viscosity	@100°C	mm <sup>2</sup> /s	ASTM D 445	11
Dynamic Viscosity	@-25°C	mPa s	ASTM D 5293	-
Viscosity Index			ASTM D 2270	103
Density	@15°C	kg/l	ASTM D 4052	0.89
Flash Point (COC)			ASTM D92	242
Pour Point			ASTM D97	-18

These characteristics are typical of current production. Whilst future production will conform to Shell's specification, variations in these characteristics may occur.

## Health, Safety &amp; Environment

## • Health and Safety

Shell Rimula R3+ is unlikely to present any significant health or safety hazard when properly used in the recommended application and good standards of personal hygiene are maintained.

Avoid contact with skin. Use impervious gloves with used oil. After skin contact, wash immediately with soap and water.

Guidance on Health and Safety is available on the appropriate Material Safety Data Sheet, which can be obtained from <http://www.epc.shell.com/>

## • Protect the Environment

Take used oil to an authorised collection point. Do not discharge into drains, soil or water.

## Additional Information

## • Advice

Advice on applications not covered here may be obtained from your Shell representative.

Doc. Title	Ship Information Handbook		170 / 226
Doc. Reference	23,3 m Trawler		
Doc. Revision & Date	A - 15/09/14		

### 6-9-3. Shell Tellus S2 V Hydraulic Oil

Product information: Hydraulic fluids

# Shell Tellus S2 V

- Extra protection
- Versatile applications



DESIGNED TO MEET CHALLENGES

Every part of your machine or process has been meticulously engineered, so you want to use a lubricant that has been designed to ensure that your equipment is well protected and works efficiently.

The Shell Tellus range of hydraulic fluids has been developed to enable equipment operators to select the oil that will deliver optimum value to their operations through

- wear protection
- long oil life
- system efficiency.

Performance at a glance			
	Protection	Oil life	System efficiency
Shell Tellus S3 V ■ Long life and improved efficiency ■ Versatile applications	✓✓✓✓	✓✓✓✓	✓✓✓✓
Shell Tellus S2 V ■ Extra protection ■ Versatile applications	✓✓✓✓	✓✓✓	✓✓✓✓
Shell Tellus S2 M ■ Extra protection ■ Industrial applications	✓✓✓	✓✓✓	✓✓✓

Performance level is a relative indication only.



#### AN EXTENDED-TEMPERATURE-RANGE HYDRAULIC FLUID

Shell Tellus S2 V uses a unique additive technology to deliver an oil life over twice the industry standards, excellent pump protection and high efficiency levels. It is a fluid that you can rely on in outdoor or cold environments, as it has been designed to have a wide operating temperature range.

Engineered to maintain its viscosity and performance over the oil-drain interval under severe mechanical stress and under hot and humid conditions, it is the most popular multigrade hydraulic oil in the Shell Tellus range. It is widely recognised and approved by leading equipment manufacturers.

**IMPROVED CLEANLINESS:** All Shell Tellus products now meet the demanding cleanliness requirements of the DIN industry standard to help provide extra protection, improved filter performance and less maintenance.

#### DESIGNED TO PROTECT

Protecting components from damage can help to increase service life and maximise your return on investment. Shell Tellus S2 V can help to achieve this by providing

- **up to 85% less wear** than the maximum allowed in the industry-standard hydraulic pump tests
- **up to 68% better protection against viscosity loss** for continuing protection and performance throughout the oil's life.

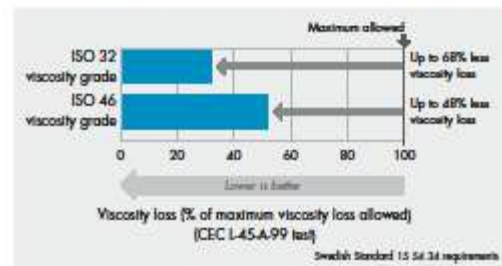
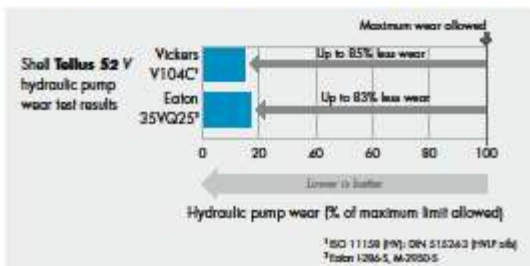

Doc. Title	Ship Information Handbook		171 / 226
Doc. Reference	23,3 m Trawler		
Doc. Revision & Date	A - 15/09/14		

**DESIGNED FOR LONG OIL LIFE**

Limiting fluid degradation can help to prolong oil life. Shell Tellus S2 V is designed to help you operate for longer without interruption – for reduced maintenance requirements and enhanced productivity. In the industry-standard oil life test, Shell Tellus S2 V achieved

- **two and a half times longer oil life** than the industry minimum.



**DESIGNED FOR HIGH EFFICIENCY**

A hydraulic fluid needs to protect, lubricate and transmit power efficiently. Shell Tellus S2 V is designed to help maximise productivity by helping equipment to meet or exceed its design capabilities. Compared with the industry minimum requirements, it offers

- **up to 62% faster air release** for efficient and precise hydraulic power transmission
- **up to 32% better filterability** in the demanding industry-standard wet test procedure to help reduce pressure loss for more efficient operation.

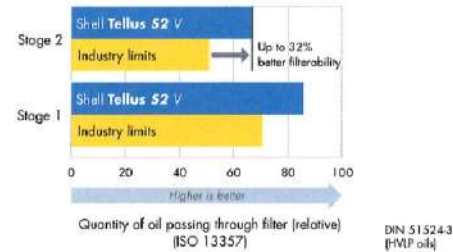
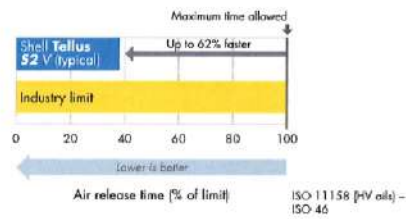

**SPECIFICATIONS AND APPROVALS**

Shell Tellus S2 V meets the requirements of a wide range of industry bodies and equipment manufacturers. ISO viscosity grades available: 15, 22, 32, 46, 68, 100.

Claims and approvals	Meets requirements
Cincinnati P-68 (ISO 32)	Svensk Standard SS 15 54 34 AM (ISO VG 32)
Cincinnati P-70 (ISO 46)	ISO 11158 HV Type
Cincinnati P-69 (ISO 68)	AFNOR NFE 48-603
Denison HFO, HF-1, HF-2	ASTM D6158-05 (HV fluids)
Eaton (Wicken) M-2950 S, I-286 S	DIN 51524-3 HVP type

**APPLICATIONS**

- Mobile and outdoor hydraulic applications – for exposed environments that are subject to wide temperature variations
- Precision hydraulic systems – for good control of fluid viscosity over the operating cycle and excellent fluid filterability

For more information, please contact

[shell.com/lubricants](http://shell.com/lubricants)

**REAL-WORLD VALUE DELIVERY**

Shell Tellus S2 V has documented value delivery in both stationary and mobile hydraulic applications across a wide range of industries. For instance:

- operators of mobile and exposed plant have increased operational efficiency
- open-cast mining and cement plants have reduced maintenance requirements and sludge-formation-related stoppages by switching from competitor oils
- stationary equipment such as presses have benefited from the fluid's greater temperature-related viscosity stability: one customer has reportedly unlocked maintenance cost savings of over \$20,000 a year<sup>1</sup>.

**FULL PRODUCT AND SERVICE PORTFOLIO**

Whatever your needs or application, Shell can provide a full range of oils and greases, including synthetic, high-performance products and additional services.

<sup>1</sup>Saving reported by one customer. Actual savings may vary, depending on the application, the current oil used, the maintenance procedures and the condition of the equipment.



Doc. Title	Ship Information Handbook		172 / 226
Doc. Reference	23,3 m Trawler		
Doc. Revision & Date	A - 15/09/14		

## 6-9-4. Bitzer BS32 Refrigerating Machine Oil



# Technische Information Technical Information Information Technique

KT-510-4

<p><b>Polyolester-Öle BSE32 und BSE55 für Hubkolbenverdichter</b></p> <p><b>Inhalt</b></p> <ol style="list-style-type: none"> <li>1 Allgemeines</li> <li>2 Anwendungsbereiche</li> <li>3 Eigenschaften der BITZER Esteröle</li> <li>4 Alternativen zu BITZER Esterölen</li> <li>5 Einsatz von Esterölen mit chlorierten (H)FCKW-Kältemitteln (R22 etc.)</li> </ol> <p><b>1 Allgemeines</b></p> <p>BITZER-Hubkolbenverdichter werden für den Einsatz chlorfreier HFKW-Kältemittel (R134a, R404A, R407A/B, R407C, R507A etc.) mit einem hochwertigen Polyolester-Öl befüllt. Bei Fabrikbefüllung erhält die Typenbezeichnung des Verdichters den Zusatz "Y" – z. B. 4CC-6.2Y.</p> <p>Esteröle bieten – im Gegensatz zu konventionellen Schmiermitteln – eine gute Löslichkeit mit HFKW-Kältemitteln und sind deshalb für den Betrieb mit diesen Stoffen zwingend erforderlich. Sie haben darüber hinaus hervorragende Schmiereigenschaften und ein günstiges Viskositätsverhalten (hoher Viskositäts-Index).</p> <p>Weitere Informationen über die Besonderheiten im Umgang mit Esterölen sowie Löslichkeitsgrenzen siehe Technische Informationen KT-620 und KT-630.</p>	<p><b>Polyolester Oils BSE32 and BSE55 for Reciprocating Compressors</b></p> <p><b>Contents</b></p> <ol style="list-style-type: none"> <li>1 General</li> <li>2 Application ranges</li> <li>3 Properties of the BITZER ester oils</li> <li>4 Alternatives to BITZER ester oils</li> <li>5 Use of ester oils with chlorinated (H)CFC refrigerants (R22 etc.)</li> </ol> <p><b>1 General</b></p> <p>BITZER reciprocating compressors which are intended for use with chlorine free HFC refrigerants (R134a, R404A, R407A/B, R407C, R507A etc.) are charged with a high quality polyolester oil. When factory charged the compressor designation has the supplement "Y" – e. g. 4CC-6.2Y.</p> <p>Contrary to conventional lubricants, ester oils provide good miscibility with HFC refrigerants and are therefore essential for the operation with these substances. Moreover they have outstanding lubrication characteristics and a favourable viscosity performance (high viscosity index).</p> <p>Further information concerning the special handling of ester oils and miscibility limits are given in the Technical Informations KT-620 and KT-630.</p>	<p><b>Huiles polyolester BSE32 et BSE55 pour compresseurs à piston</b></p> <p><b>Sommaire</b></p> <ol style="list-style-type: none"> <li>1 Généralités</li> <li>2 Champs d'application</li> <li>3 Propriétés des huiles ester de BITZER</li> <li>4 Alternatives aux huiles ester de BITZER</li> <li>5 Emploi d'huiles ester avec des fluides frigorigènes chlorés (H)CFC (R22 etc.)</li> </ol> <p><b>1 Généralités</b></p> <p>Les compresseurs à pistons BITZER prévus pour travailler avec un fluide frigorigène non chloré HFC (R134a, R404A, R407A/B, R407C, R507A, etc.) sont livrés avec une charge d'huile polyolester de haute qualité. Pour les compresseurs "chargés" en usine, la désignation du type est complétée par la lettre "Y" – par exemple 4CC-6.2Y.</p> <p>Contrairement aux lubrifiants conventionnels, les huiles ester sont miscibles avec les fluides frigorigènes HFC si bien que leur emploi avec ces substances s'impose forcément. De plus, ces huiles présentent de très bonnes caractéristiques lubrifiantes et un comportement avantageux de la viscosité (indice de viscosité élevé).</p> <p>Pour d'autres informations relatives aux particularités et à l'utilisation des huiles ester ainsi qu'aux limites de miscibilité, se référer aux Informations techniques KT-620 et KT-630.</p>
---	--	--

Doc. Title	Ship Information Handbook		173 / 226
Doc. Reference	23,3 m Trawler		
Doc. Revision & Date	A - 15/09/14		



**2 Anwendungsbereiche**

**2 Application ranges**

**2 Champs d'application**

**2.1 BSE32**

**2.1 BSE32**

**2.1 BSE32**

Basisviskosität 32 cSt bei 40°C

Basic viscosity 32 cSt at 40°C

Viscosité de base 32 cST à 40°C

Kältemittel Refrigerant Fluide frigorigène	Anwendungsbereich Application range Champs d'application	Erläuterungen Comments Commentaires
R134a	- H M (L)	stationäre Kälte- und Klimaanlage bis zu einer Verflüssigungstemperatur von 55°C stationary refrigeration and air conditioning plants with condensing temperatures up to 55°C installations de réfrigération et de conditionnement d'air stationnaires jusqu'à une température de condensation de 55°C
R404A	- (H) M L	
R407A	- (H) M L	
R407B	- - M L	
R407C	H M	
R507A	- (H) M L	
R22	- - M L	siehe besondere Hinweise, Kapitel 5 see special recommendation, chapter 5 voir recommandations particulières, chapitre 5

**2.2 BSE55**

**2.2 BSE55**

**2.2 BSE55**

Basisviskosität 55 cSt bei 40°C

Basic viscosity 55 cSt at 40°C

Viscosité de base 55 cST à 40°C

Kältemittel Refrigerant Fluide frigorigène	Anwendungsbereich Application range Champs d'application	Erläuterungen Comments Commentaires
R22	- H M L	siehe besondere Hinweise, Kapitel 5 see special recommendation, chapter 5 voir recommandations particulières, chapitre 5
R134a	HH H M (L)	mobile Kälte- und Klimaanlage sowie stationäre Anlagen bei Verflüssigungstemperaturen > 55°C mobile refrigeration and air conditioning plants and stationary systems with condensing temperatures > 55°C installations de réfrigération et de conditionnement d'air mobiles et installations stationnaires pour une temp. de condensation > 55°C
R407C	- H M -	
R410A	- H M (L)	stationäre Kälte- und Klimaanlage stationary refrigeration and air conditioning plants installations de réfrigération et de conditionnement d'air stationnaires

**Definition der Anwendungsbereiche**

HH Hochklimabereich (t<sub>o</sub> bis 25°C)  
H Klimabereich  
M Normalkühl-Bereich  
L Tiefkühl-Bereich  
() Weniger empfohlener Anwendungsbereich (teilweise Einschränkungen z. B. L-Bereich bei R134a)

**Definition of application ranges**

HH high temperature air conditioning (t<sub>o</sub> up to 25°C)  
H air conditioning range  
M medium temperature range  
L low temperature range  
() application range less recommended (partly restrictions e.g. L range in case of R134a)

**Définition des champs d'application**

HH climatisation à haute températures (t<sub>o</sub> jusqu'à 25°C)  
H domaine de climatisation  
M domaine à moyenne température  
L domaine de congélation  
() champ d'application peu recommandé (restrictions partielles par exemple champ d'application L pour R134a)

Doc. Title	Ship Information Handbook		174 / 226
Doc. Reference	23,3 m Trawler		
Doc. Revision & Date	A - 15/09/14		



**2 Anwendungsbereiche**

**2 Application ranges**

**2 Champs d'application**

**2.1 BSE32**

**2.1 BSE32**

**2.1 BSE32**

Basisviskosität 32 cSt bei 40°C

Basic viscosity 32 cSt at 40°C

Viscosité de base 32 cST à 40°C

Kältemittel Refrigerant Fluide frigorigène	Anwendungsbereich Application range Champs d'application	Erläuterungen Comments Commentaires
R134a	- H M (L)	stationäre Kälte- und Klimaanlage bis zu einer Verflüssigungstemperatur von 55°C stationary refrigeration and air conditioning plants with condensing temperatures up to 55°C installations de réfrigération et de conditionnement d'air stationnaires jusqu'à une température de condensation de 55°C
R404A	- (H) M L	
R407A	- (H) M L	
R407B	- - M L	
R407C	H M	
R507A	- (H) M L	
R22	- - M L	siehe besondere Hinweise, Kapitel 5 see special recommendation, chapter 5 voir recommandations particulières, chapitre 5

**2.2 BSE55**

**2.2 BSE55**

**2.2 BSE55**

Basisviskosität 55 cSt bei 40°C

Basic viscosity 55 cSt at 40°C

Viscosité de base 55 cST à 40°C

Kältemittel Refrigerant Fluide frigorigène	Anwendungsbereich Application range Champs d'application	Erläuterungen Comments Commentaires
R22	- H M L	siehe besondere Hinweise, Kapitel 5 see special recommendation, chapter 5 voir recommandations particulières, chapitre 5
R134a	HH H M (L)	mobile Kälte- und Klimaanlage sowie stationäre Anlagen bei Verflüssigungstemperaturen > 55°C mobile refrigeration and air conditioning plants and stationary systems with condensing temperatures > 55°C installations de réfrigération et de conditionnement d'air mobiles et installations stationnaires pour une temp. de condensation > 55°C
R407C	- H M -	
R410A	- H M (L)	stationäre Kälte- und Klimaanlage stationary refrigeration and air conditioning plants installations de réfrigération et de conditionnement d'air stationnaires

**Definition der Anwendungsbereiche**

HH Hochklimabereich (t<sub>0</sub> bis 25°C)  
H Klimabereich  
M Normalkühl-Bereich  
L Tiefkühl-Bereich  
( ) Weniger empfohlener Anwendungsbereich (teilweise Einschränkungen z. B. L-Bereich bei R134a)

**Definition of application ranges**

HH high temperature air conditioning (t<sub>0</sub> up to 25°C)  
H air conditioning range  
M medium temperature range  
L low temperature range  
( ) application range less recommended (partly restrictions e.g. L range in case of R134a)

**Définition des champs d'application**

HH climatisation à haute températures (t<sub>0</sub> jusqu'à 25°C)  
H domaine de climatisation  
M domaine à moyenne température  
L domaine de congélation  
( ) champ d'application peu recommandé (restrictions partielles par exemple champ d'application L pour R134a)

Doc. Title	Ship Information Handbook		175 / 226
Doc. Reference	23,3 m Trawler		
Doc. Revision & Date	A - 15/09/14		



**3 Eigenschaften der BITZER Esteröle**

**3 Properties of the BITZER ester oils**

**3 Propriétés des huiles ester de BITZER**

**3.1 Technische Daten**

**3.1 Technical data**

**3.1 Données techniques**

Ölsorte Oil type Type d'huile	Dichte bei 15°C Density at 15°C Densité à 15°C g/ml	Flammpunkt Flash point Point d'éclair °C	Stockpunkt Pour-point Point d'écoulement °C	Kinematische Viskosität (cSt) Kinematic viscosity (cSt) Viscosité cinématique (cSt)		
				20°C	40°C	100°C
BSE32	1,006	243	-48	88,1	31,2	6,0
BSE55	1,010	270	-51	149,4	55,0	8,8

**3.2 Mischungsgrenzen**

**3.2 Miscibility limits**

**3.2 Limites de miscibilité**



Abb. 1 Mischungsgrenzen  
Gewichtsanteil Öl im Kältemittel

Fig. 1 Miscibility limits  
Weight percentage oil in refrigerant

Fig.1 Limites de miscibilité  
Pourcentage de masse d'huile dans  
fluide frigorigène

Doc. Title	Ship Information Handbook		176 / 226
Doc. Reference	23,3 m Trawler		
Doc. Revision & Date	A - 15/09/14		

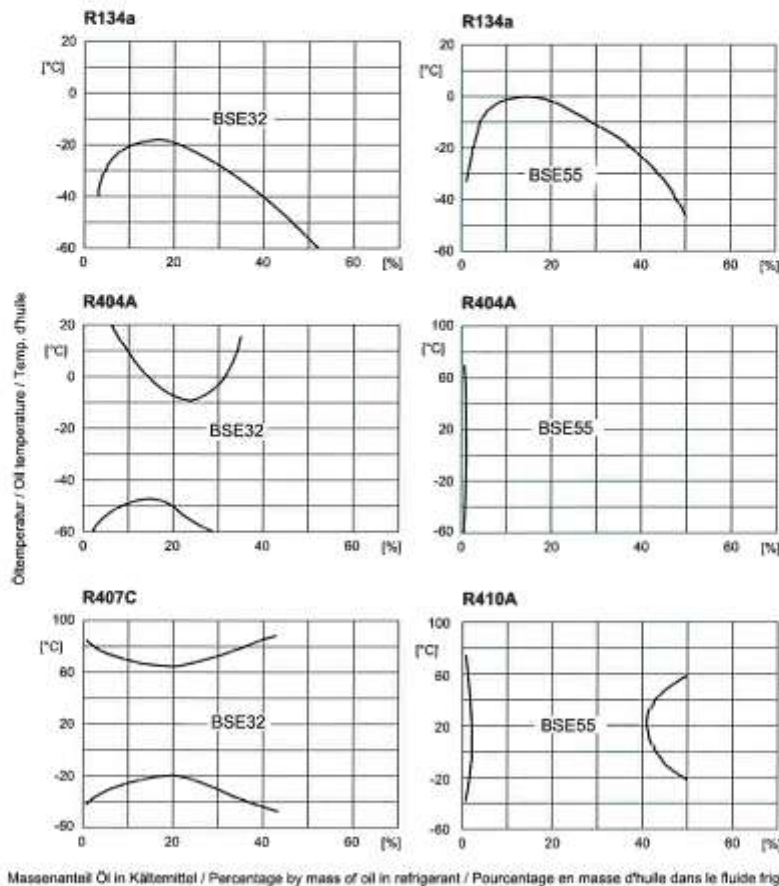



3.3 Kältemittel-Konzentration im Öl    3.3 Refrigerant concentration in oil    3.3 Concentration de fluide frigorigène dans l'huile



Abb. 2 Kältemittel-Konzentration (Massen %) im Öl in Abhängigkeit von Kältemitteldruck und Öltemperatur

Fig. 2 Refrigerant solution in oil depending on refrigerant pressure and oil (mass %) temperature

Fig. 2 Concentration de fluide frigorigène dans l'huile (masse %) en fonction de la pression du fluide frigorigène et de la température de l'huile

Doc. Title	Ship Information Handbook		177 / 226
Doc. Reference	23,3 m Trawler		
Doc. Revision & Date	A - 15/09/14		

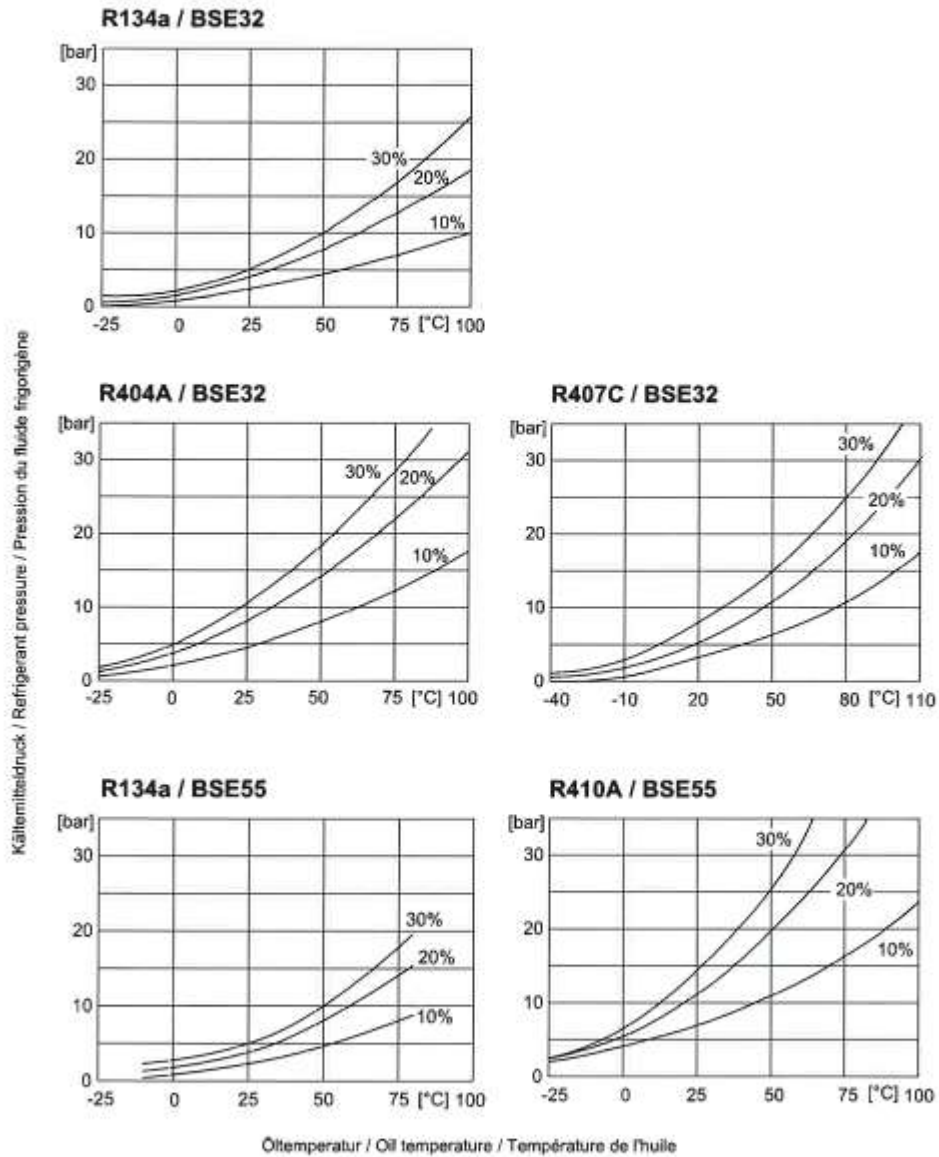

**4 Alternativen zu BITZER Esterölen**

**4.1 BSE32**

Lieferant	Ölsorte
Deutsche BP	Castrol Icematic SW 32
CPI	Solest 31-HE
ExxonMobil	EAL Arctic 22 CC EAL Arctic 32
Fuchs	SEZ 32
Shell	Clavus R32
Uniquema	RL 32 H

**4.2 BSE55**

Lieferant	Ölsorte
Deutsche BP	Castrol Icematic SW 68
CPI	Solest 68
ExxonMobil	EAL Arctic 68
Fuchs	SE 55
Shell	Clavus R68
Uniquema	RL 68 S

Die genannten Alternativ-Öle entsprechen in ihren Eigenschaften weitgehend der Originalfüllung BSE32 und BSE55. Eine Mischung mit dem Originalöl ist möglich – innerhalb der jeweiligen Viskositätsgruppe –, sofern entsprechende eigene oder vergleichende Erfahrungen für den betreffenden Anwendungsfall vorliegen. Grundlegende Voraussetzungen für den Einsatz von Alternativ-Ölen sind vom Hersteller bzw. Lieferanten garantierte Produktqualität und Feuchtigkeitswerte (< 50 ppm).

**Achtung!**  
Wegen der spezifischen Formulierung des BSE55 mit Blick auf die tribologischen Eigenschaften, darf für die Erstbefüllung der Verdichter nur Originalöl verwendet werden. Oben gelistete Alternativen sind nur für den Servicefall zugelassen.

**4 Alternatives to BITZER ester oils**

**4.1 BSE32**

Supplier	Oil type
Deutsche BP	Castrol Icematic SW 32
CPI	Solest 31-HE
ExxonMobil	EAL Arctic 22 CC EAL Arctic 32
Fuchs	SEZ 32
Shell	Clavus R32
Uniquema	RL 32 H

**4.2 BSE55**

Supplier	Oil type
Deutsche BP	Castrol Icematic SW 68
CPI	Solest 68
ExxonMobil	EAL Arctic 68
Fuchs	SE 55
Shell	Clavus R68
Uniquema	RL 68 S

The characteristics of the alternative oils listed mainly correspond to the original BSE32 and BSE55 charge. It is also possible to mix these with the original oil, within the respective viscosity group, as long as appropriate own or comparable experience is available for the application concerned. The basic assumption for the use of these alternatives is that the manufacturer or supplier guarantees the product quality and the moisture content (< 50 ppm).

**Attention!**  
Due to the specific formulation of BSE55 with respect to the tribological characteristics, only original oil shall be used for the first charge of the compressor. The alternatives listed above are allowed only in case of service.

**4 Alternatives aux huiles ester de BITZER**

**4.1 BSE32**

Fournisseur	Type d'huile
Deutsche BP	Castrol Icematic SW 32
CPI	Solest 31-HE
ExxonMobil	EAL Arctic 22 CC EAL Arctic 32
Fuchs	SEZ 32
Shell	Clavus R32
Uniquema	RL 32 H

**4.2 BSE55**

Fournisseur	Type d'huile
Deutsche BP	Castrol Icematic SW 68
CPI	Solest 68
ExxonMobil	EAL Arctic 68
Fuchs	SE 55
Shell	Clavus R68
Uniquema	RL 68 S

Les alternatives précitées présentent approximativement les mêmes propriétés que les charges d'huile d'origine, à savoir BSE32 et BSE55. A l'intérieur d'un même "groupe" de viscosité un mélange avec l'huile d'origine est possible, dans la mesure où l'on dispose de l'expérience suffisante (ou d'expériences comparables) pour le champ d'application concerné. Les conditions préliminaires à l'emploi d'huiles alternatives sont une qualité de produit et une teneur en eau (< 50 ppm) garanties par le producteur resp. le fournisseur.

**Attention !**  
En raison de la formulation spécifique du BSE55 relative aux propriétés tribologiques, utiliser uniquement de l'huile d'origine pour le premier remplissage des compresseurs. D'autres alternatives listées ci-dessus ne sont autorisées que pour l'entretien.

Doc. Title	Ship Information Handbook		178 / 226
Doc. Reference	23,3 m Trawler		
Doc. Revision & Date	A - 15/09/14		



### 5 Einsatz von Esterölen mit chlorierten (H)FCKW-Kältemitteln (R22 etc.)

Inzwischen besteht auch bei Anlagen mit (H)FCKW-Kältemitteln ein Trend zur Befüllung der Verdichter mit Esteröl, um eine spätere Umstellung auf chlorfreie Kältemittel zu vereinfachen. Esteröle sind grundsätzlich auch für derartige Anwendungen geeignet, jedoch besteht ein deutlich erhöhtes Risiko hinsichtlich Verdichterverschleiß und chemischer Stabilität des Kältekreislaufs. Dies gilt selbst im Hinblick darauf, dass in BITZER-Verdichtern nur besonders hochwertige Materialien zum Einsatz kommen – u. a. nitrierte Wellen, sonderbehandelte Lager, hartverchromte Verdichtungsringe, Edelstahl-Arbeitsventile.

Auch das Argument einer vereinfachten Umstellung auf chlorfreie Alternativstoffe gilt nur unter Einschränkung. Eine qualifizierte Umstellung erfordert auf Grund der unvermeidlichen Kontaminierung des Öls mit Chlor aus dem (H)FCKW-Kältemittel ohnehin einen mehrfachen Ölwechsel.

Der Einsatz von Esteröl in Verbindung mit (H)FCKW-Kältemitteln sollte immer sorgfältig abgewogen werden, wobei folgende Punkte berücksichtigt werden müssen:

- Beim Betrieb mit (H)FCKW ist die im Esteröl gelöste Kältemittelmenge mehr als doppelt so hoch als bei herkömmlichen Schmierstoffen oder bei Verwendung von Esteröl in Verbindung mit chlorfreien HFCKW. Daraus resultiert vor allem bei hohen Saugdrücken und niedriger Öltemperatur eine starke Viskositätsminderung mit der Gefahr eines erhöhten Verschleißes. Besonders kritisch ist dabei der Startvorgang nach längeren Stillstandszeiten.
- Esteröle sind stark hygroskopisch. Sie erfordern deshalb bei (H)FCKW auf Grund des Chloranteils einen besonders hohen Trocknungsgrad (< 50 ppm), der in der Praxis nur mit erheblichem Aufwand erreicht werden kann. Überhöhte Feuchtigkeitswerte führen zu Hydrolyse und damit zu Säurebildung und Kupferplattierung sowie in der Folge zu Verdichterschaden.

### 5 Use of ester oils with chlorinated (H)CFC refrigerants (R22 etc.)

A trend also exists towards charging compressors with ester oil for plants with (H)CFC refrigerants, to simplify a subsequent conversion to chlorine free refrigerant. Ester oils are generally suitable for such applications, however, a significantly increased risk exists regarding compressor wear and the chemical stability of the system. This applies even though BITZER compressors are constructed with high quality materials such as surface hardened shafts, specially treated bearings, hard chrome plated compression rings and high alloy steel valve reeds.

The argument that the conversion to alternative refrigerants is simplified is only valid with certain restrictions. A qualified conversion requires repeated oil changes due to the unavoidable contamination of the oil with chlorine from the (H)CFC refrigerant.

The use of ester oil in combination with (H)CFC refrigerants should always be considered carefully especially regarding the following points:

- When operating with (H)CFC the quantity of refrigerant dissolved in the ester oil is more than double as with conventional lubricants or when operating with a combination of ester oil and chlorine free HFC. This results in a strong viscosity reduction and the danger of increased wear, especially in cases of high suction pressure and low oil temperature. The starting procedure after a long period of standstill is particularly critical.
- Ester oils are strongly hygroscopic and therefore require a very high degree of dehydration (< 50 ppm) when used with (H)CFC due to the chlorine content; this can only be achieved in practice with a considerable effort. Excessive moisture content leads to hydrolysis and thereby to acid formation with copper plating resulting in damage to the compressor.

### 5 Emploi d'huiles ester avec des fluides frigorigènes chlorés (H)CFC (R22 etc.)

Entre-temps, il existe une tendance au remplissage des compresseurs avec de l'huile ester même quand ceux-ci sont prévus pour travailler avec des fluides (H)CFC, ceci en vue de la simplification d'une conversion future avec un fluide exempt de chlore. En principe, les huiles ester sont adaptées à ce type d'emploi mais il subsiste un risque accru d'usure du compresseur et de stabilité chimique du circuit frigorifique. Ceci reste valable tout en sachant que seuls des matériaux de très hautes qualités sont employés dans les compresseurs BITZER – entre autre, vilebrequin nituré, roulements spécialement traités, segments chromés dur, clapets de travail en acier inoxydable.

De même, l'argumentation d'une conversion simplifiée avec des produits de substitution exempts de chlore n'est valable que sous certaines restrictions. Une conversion de qualité nécessite, en raison de la contamination inévitable de l'huile avec du chlore (du fluide frigorigène (H)CFC), plusieurs vidanges d'huile.

L'emploi d'une huile ester avec des fluides frigorigènes (H)CFC devrait toujours être soigneusement réfléchi, en tenant compte des points suivants:

- En fonctionnement avec un fluide (H)CFC, la quantité de fluide frigorigène en solution dans l'huile ester est le double de celle avec un lubrifiant conventionnel, ou lors de l'emploi d'une huile ester avec un fluide HFC exempt de chlore. Il en résulte une forte diminution de la viscosité avec un risque d'usure plus important, principalement pour des pressions d'aspiration élevées et une faible température de l'huile. La phase de démarrage après de longues arrêts est particulièrement critique.
- Les huiles ester sont fortement hygrosco-piques et nécessitent par conséquent pour les (H)CFC, en raison de la présence de chlore, un degré de dessiccation particulièrement poussé (< 50 ppm) qui, en pratique, n'est obtenu qu'avec une importante mise en oeuvre. Une teneur en eau trop élevée engendre une hydrolyse et par conséquent une formation d'acide et de dépôts de cuivre qui peuvent aboutir à des dégâts sur le compresseur.

Doc. Title	Ship Information Handbook		179 / 226
Doc. Reference	23,3 m Trawler		
Doc. Revision & Date	A - 15/09/14		



- Esteröle haben ein besonders gutes Löslichkeitsverhalten gegenüber Schmutzablagerungen in der Anlage. Sie erhöhen damit die Gefahr einer Schädigung des Verdichters durch abgelösten Schmutz.

- Ester oils have an especially good solubility behaviour with regard to system dirt deposits and therefore increase the danger of damage to the compressor due to loosened dirt.

- Les huiles ester présentent la particularité de dissoudre fortement les dépôts d'impureté résiduels du système frigorifique ce qui augmente le risque de détérioration du compresseur par les impuretés qui ont été détachées.

**Resultierende Anforderungen**

- Betrieb bei Klimabedingungen (H-Bereich) und Einspritzkühlung (CIC) mit einstufigen Verdichtern:
  - Esteröl mit höherer Basisviskosität einsetzen (BSE55 an Stelle von BSE32).
- Bei der Montage:
  - grundsätzlich nur Rohrleitungen und Anlagen-Komponenten verwenden, die innen sauber und trocken sind (frei von Zunder, Metallspänen, Rost- und Phosphat-Schichten) und die luftdicht verschlossen angeliefert werden
  - reichlich dimensionierten Trockner einbauen
  - saugseitigen Reinigungsfilter einbauen
  - Öl sorgfältig handhaben: Öl vor Feuchtigkeit schützen. Nur originalverschraubte Öldosen verwenden!
- Bei der Inbetriebnahme:
  - hochgradig evakuieren
- Betrieb:
  - nur innerhalb abgesicherter Temperaturgrenzen
  - Ölumpfheizung hoher Leistung verwenden
  - Trockner nach ca. 100 Betriebsstunden erneuern
- Mit der Anlagensteuerung sicherstellen:
  - ausreichende Sauggasüberhitzung
  - Kurzzeitbetrieb vermeiden
  - gegen Flüssigkeitsschläge absichern
  - ggf. Abpumpschaltung vorsehen

**Resulting requirements**

- Operation at air conditioning range (H range) and injection cooling (CIC) with single stage compressors:
  - Use ester oil with a higher basic viscosity (BSE55 instead of BSE32).
- While mounting:
  - Only use tubes and components which are clean and dry inside (free from slag, swarf, rust, and phosphate coatings) and which are delivered with an air tight seal
  - install generously sized drier
  - install suction side cleaning filter
  - handle the oil carefully: Keep oil dry. Use oil from originally sealed containers only!
- While commissioning:
  - evacuate to a high-grade vacuum
- Operation:
  - within controlled temperature limits only
  - use a high capacity crankcase heater
  - change the drier after approximately 100 operating hours
- Ensure with plant control:
  - sufficient suction gas superheat
  - avoid short operating periods
  - protect against liquid slugging
  - in certain cases provide a pump down system

**Exigences résultantes**

- Fonctionnement dans le domaine de climatisation (champ d'application H) et en cas de refroidissement par injection de liquide (CIC) avec un compresseur mono-étagé:
  - Employer une huile ester avec une viscosité de base plus élevée (BSE55 au lieu de BSE32).
- Pendant le montage:
  - ne utiliser que des tubes et des composants, qui sont propres et secs à l'intérieur (pas de calamine, de copeaux métalliques, de dépôts de rouille et de phosphates) et qui sont livrés hermétiquement clos
  - installer un déshydrateur largement dimensionné
  - installer un filtre de nettoyage à aspiration
  - Manipuler l'huile avec précaution: Protéger l'huile contre l'humidité. N'utiliser que des bidons d'huile fermés d'origine!
- Pendant la mise en service:
  - réaliser un vide poussé
- Fonctionnement:
  - seulement dans les limites de températures autorisées
  - utiliser une résistance de carter de puissance élevée
  - remplacer le déshydrateur après environ 100 heures de fonctionnement
- Assurer avec la commande d'installation:
  - surchauffe à l'aspiration suffisante
  - éviter les courts cycles
  - prévenir des coups de liquide
  - prévoir éventuellement une commande par pump down

Doc. Title	Ship Information Handbook		180 / 226
Doc. Reference	23,3 m Trawler		
Doc. Revision & Date	A - 15/09/14		



#### Hinweise

- Wegen der besonderen Risiken mit Esterölen in (H)FCKW-Kältekreisläufen bleibt im Falle eines Verdichterschadens die Beurteilung eines Garantieanspruches der individuellen Überprüfung des Verdichters im Werk vorbehalten.
- Alle Verdichter der "2-Generation" können bereits mit den chlorfreien Stoffen R134a, R404A, R407A, R407B, R407C und R507A eingesetzt werden. Dabei kommen die positiven Eigenschaften von Esteröl voll zum Tragen. Eine solche Lösung sollte deshalb gegenüber (H)FCKW-Systemen mit Esteröl bevorzugt werden.

#### Recommendations

- Due to the special risks with ester oils and (H)CFC refrigerant circuits, in the case of compressor damage we reserve the right to assess a guarantee claim according to an individual examination of the compressor in our factory.
- All compressors of the "2-Generation" can already be used with R134a, R404A, R407A, R407B, R407C and R507A. Hereby the positive characteristics of ester oils are fully exploited. Such a solution should therefore be preferred over an (H)CFC system with ester oil.

#### Indications

- En raison des risques particuliers avec les huiles ester dans des circuits frigorifiques avec des fluides (H)CFC, le gain de la garantie, en cas de détérioration du compresseur, est assujéti au contrôle spécifique du compresseur en usine.
- Tous les compresseurs de la "génération .2" peuvent être utilisés avec les fluides frigorigènes exempts de chlore R134a, R404A, R407A, R407B, R407C et R507A. Dans ce cas, les propriétés positives des huiles ester sont pleinement exploitées. Par conséquent, une solution de ce genre devrait être préférée à celle de systèmes avec un fluide (H)CFC et une huile ester.

**BITZER**  
G · R · O · U · P O · F C · O · M · P · A · N · I · E · S

Bitzer Kühlmaschinenbau GmbH  
Eschenbrunnlestraße 15 • 71065 Sindelfingen, Germany  
fon +49 (0) 70 31 932-0 • fax +49 (0) 70 31 932-146 & -147  
www.bitzer.de • bitzer@bitzer.de

Kühlmaschinenbau / Refrigeration / Frigorifiques / Chillers / Thermos modifizierten Standard 07/07

Doc. Title	Ship Information Handbook		181 / 226
Doc. Reference	23,3 m Trawler		
Doc. Revision & Date	A - 15/09/14		

## 6-9-5. Shell Omala Oils



Previous Name: Shell Omala Oils

## Shell Omala S2 G

### Industrial Gear Oils

- EXTRA PROTECTION
- STANDARD APPLICATIONS

Shell Omala S2 G oils are high quality extreme-pressure oils designed primarily for the lubrication of heavy duty industrial gears. Their high load carrying capacity and anti-friction characteristics combine to offer superior performance in gears.

#### Performance Benefits

- *Long oil life – Maintenance saving*

Shell Omala S2 G oils are formulated to resist thermal and chemical breakdown throughout the maintenance interval. They withstand high thermal loading and resist the formation of sludge to provide extended oil life capability, even with bulk oil temperatures of up to 100°C in certain applications.

- *Excellent wear & corrosion protection*

Excellent load carrying capacity reduces gear tooth and bearing wear on both steel and bronze components.

Shell Omala S2 G has excellent corrosion protection, protecting both steel and bronze components, even in the presence of contamination by water and solids.

- *Maintaining system efficiency*

Shell Omala S2 G oils have excellent water separation properties, such that excess water can be drained easily from lubrication systems to help extend the life of the gears and ensure efficient lubrication of the contact areas.

Water can greatly accelerate surface fatigue of gears and bearings as well as promoting ferrous corrosion on internal surfaces. Water contamination should therefore be avoided or removed as quickly as possible after the occurrence.

#### Applications

- *Enclosed industrial gear systems*

Shell Omala S2 G oils are formulated using an effective sulphur-phosphorus additive system to provide an extreme pressure performance which allow trouble-free application in most enclosed industrial gearboxes using steel spur and helical gears.

- *Highly loaded gears*

Shell Omala S2 G oils have an effective full extreme pressure (EP) additive system allowing them to be used in highly-loaded gear systems.

- *Other applications*

Shell Omala S2 G oils are suitable for lubrication of bearings and other components in circulating and splash-lubricated systems

For highly-loaded worm drives the Shell Omala "W" series oils are recommended.

For automotive hypoid gears, the appropriate Shell Spirax Oil should be used.

#### Specifications and Approvals

Meets ISO 12925-1 Type CKD, except ISO 680-1000

Meets DIN 51517- Part 3 (CLP), except ISO 680-1000

Meets AGMA 9005- EO2 (EP)

Meets US Steel 224

Meets David Brown S1.53.101,102,103,104

Meets Cincinnati Machine P34,35,59,63,74,76-78

Doc. Title	Ship Information Handbook		182 / 226
Doc. Reference	23,3 m Trawler		
Doc. Revision & Date	A - 15/09/14		



### Health and Safety

Guidance on Health and Safety is available on the appropriate Material Safety Data Sheet, which can be obtained from your Shell representative.

### Protect the Environment

Take used oil to an authorized collection point. Do not discharge into drains, soil or water.

### Advice

Advice on applications not covered in this leaflet may be obtained from your Shell representative.

### Typical Physical Characteristics

Shell Omala S2 G		68	100	150
ISO Viscosity Grade	ISO 3448	68	100	150
Kinematic Viscosity	ISO 3104			
at 40°C	mm <sup>2</sup> /s	68	100	150
at 100°C	mm <sup>2</sup> /s	8.7	11.4	15.0
Viscosity Index	ISO 2909	99	100	100
Flash Point COC	°C ISO 2592	236	240	240
Pour Point	°C ISO 3016	-24	-24	-24
Density at 15°C	kg/m <sup>3</sup> ISO 12185	887	891	897

Shell Omala S2 G		220	320	460
ISO Viscosity Grade	ISO 3448	220	320	460
Kinematic Viscosity	ISO 3104			
at 40°C	mm <sup>2</sup> /s	220	320	460
at 100°C	mm <sup>2</sup> /s	19.4	25.0	30.8
Viscosity Index	ISO 2909	100	100	97
Flash Point COC	°C ISO 2592	240	255	260
Pour Point	°C ISO 3016	-18	-15	-12
Density at 15°C	kg/m <sup>3</sup> ISO 12185	899	903	904

Shell Omala S2 G		680	1000
ISO Viscosity Grade	ISO 3448	680	1000
Kinematic Viscosity	ISO 3104		
at 40°C	mm <sup>2</sup> /s	680	1000
at 100°C	mm <sup>2</sup> /s	38.0	45.4
Viscosity Index	ISO 2909	92	85
Flash Point COC	°C ISO 2592	272	290
Pour Point	°C ISO 3016	-9	-6
Density at 15°C	kg/m <sup>3</sup> ISO 12185	912	931

These characteristics are typical of current production. Whilst future production will conform to Shell's specification, variations in these characteristics may occur.

Doc. Title	Ship Information Handbook		183 / 226
Doc. Reference	23,3 m Trawler		
Doc. Revision & Date	A - 15/09/14		

## 6-9-6. Shell Lurop V

**Shell Lurop V**

Lubrifiant biodégradable pour câbles

**Description**

Shell Lurop V est un fluide de maintenance pour câbles biodégradable et exempt d'huile minérale. Il assure une excellente protection contre la corrosion et se comporte très favorablement envers les bandages en caoutchouc et plastique des rouleaux et des roues d'entraînement des câbles. Shell Lurop V est un lubrifiant universel pour toutes les sortes de câbles. Le produit est pré-dilué avec un solvant pour faciliter son application et l'infiltration. Un film lubrifiant fin et huileux, non collant, très adhérent subsiste après l'évaporation du solvant.

**Caractéristiques**

- ▲ excellente propriété adhésion
- ▲ bonne biodégradabilité
- ▲ bonne protection anticorrosive

**Domaine d'utilisation**

- ▲ L'application se fait à l'aide d'un appareil de graissage
- ▲ La quantité de recouvrement devrait se situer entre 15 et 20 g/m<sup>2</sup>, avant évaporation du solvant
- ▲ Un temps de séchage de quelques heures après l'application devrait être prévu pour favoriser l'adhérence du film d'huile et l'évaporation du solvant.
- ▲ La lubrification des câbles devrait avoir lieu par temps sec pour obtenir une protection contre la corrosion optimale
- ▲ Un nettoyage en profondeur est une condition préliminaire indispensable pour assurer une lubrification et une protection efficace des câbles
- ▲ Shell Lurop V est pré-dilué à l'aide d'un solvant, une dilution complémentaire peut être effectuée le cas échéant au moyen du solvant Shell Solvent SM. Aucun autre solvant n'est autorisé.

**Compatibilité avec joints et vernis**

Compatible avec les vernis, élastomères et joints utilisés couramment pour l'huile minérale

**Valeurs typiques**

Shell Lurop V			
Caractéristique	Méthode		
Couleur			bleue
Densité à 15°C	kg/m <sup>3</sup>	ISO 12185	953
Viscosité cinématique à 20°C	mm <sup>2</sup> /s	ISO 3104	100
Teneur en solvant	%		30
Point d'éclair	°C	EN 57	64
Biodégradabilité	%	OECD 301 B	>75
Code de danger (SPI)			F 3   Fu PN3

Valeurs moyennes soumises aux tolérances usuelles. Modifications réservées.

Doc. Title	Ship Information Handbook		184 / 226
Doc. Reference	23,3 m Trawler		
Doc. Revision & Date	A - 15/09/14		



## 6-9-7. Shell Alvania Greases EP

## Shell Alvania Greases EP(LF)

### General purpose extreme-pressure industrial grease

THICKENER	NLGI	TEMP RANGE	BASE OIL VISCOSITY		EP	WATER RESISTANCE
LITHIUM	00, 0, 1, 2 & 3	-20°C to +120°C	40°C 189 cSt	100°C 15.6 cSt	✓✓	☆☆

Shell Alvania Greases EP(LF) offer the excellent performance expected of the world's leading brand of grease.

They are premier quality, multipurpose, extreme-pressure industrial greases based on a blend of high viscosity index mineral oils and a lithium hydroxystreate soap thickener and contain lead free extreme-pressure and other proven additives.

Shell Alvania Greases EP(LF) are designed for the grease lubrication of rolling element and plain bearings such as those found in the steel, paper, mining, quarrying and construction industries.

#### Applications

Shell Alvania Greases EP(LF) 0 & 00 are specifically designed for:

- Steel mill lubrication where a softer grease is necessary for specialised dispensing systems.
- Heavy duty plain and rolling element bearings operating under severe conditions including shock loading in wet environments
- Gearbox applications where semi-fluid greases are required

Shell Alvania Grease EP(LF) 1 is designed for:

- Heavy duty bearings served by centralised dispensing equipment
- Extreme-pressure gear grease for applications at normal ambient temperature
- Heavy duty plain and rolling element bearings operating under severe conditions including shock loading in wet environments
- Low temperature greasing applications

#### Shell Alvania Grease EP(LF) 2 & 3

are designed for:

- Heavy duty bearings and general industrial lubrication
- Heavy duty plain and rolling element bearings operating under severe conditions including shock loading in wet environments
- Operation over the temperature range -20°C to 100°C for bearings operating at 75% of the maximum rated speed (Can withstand up to 120°C intermittently)

#### Performance Features

- **Outstanding load carrying capacity**  
Shell Alvania Greases EP(LF) contain special extreme-pressure additives which enable them to withstand heavy and shock loads without failure of the lubricant film.
- **Superior mechanical stability**  
Compared to 'lead' Alvania, the resistance to extended mechanical working is significantly improved. This is particularly important in vibrating environments where poor mechanical stability can lead to grease softening with subsequent loss of lubrication performance and leakage.

October 2007

1/2

Version 2

Doc. Title	Ship Information Handbook		185 / 226
Doc. Reference	23,3 m Trawler		
Doc. Revision & Date	A - 15/09/14		

- **Excellent resistance to water wash-out**  
Shell Alvania Greases EP(LF) have been formulated to offer much improved levels of resistance to water wash-out compared to the old leaded product.
- **Oxidation stability**  
Specially selected base oil components have excellent oxidation resistance. Their consistency will not alter in storage and they withstand high operating temperatures without hardening or forming bearing deposits
- **Excellent corrosion protection**  
Shell Alvania Greases EP(LF) have a strong affinity with metal and have the ability to protect bearing surfaces against corrosion, even when the grease is contaminated with water.

#### Performance Specifications

Meet the British Timken specification for Steel Mill applications

#### Re-greasing Intervals

For bearings operating near their maximum recommended temperatures, re-greasing intervals should be reviewed

#### Health & Safety

Shell Alvania Greases EP(LF) are unlikely to present any significant health or safety hazard when properly used in the recommended application, and good standards of industrial and personal hygiene are maintained.

For further guidance on Product Health & Safety refer to the appropriate Shell Product Safety Data Sheet.

#### Typical Physical Characteristics

Shell Alvania Grease EP(LF)	00	0	1	2	3
Soap Type	Lithium	Lithium	Lithium	Lithium	Lithium
Base Oil	Mineral	Mineral	Mineral	Mineral	Mineral
Kinematic Viscosity @ 40°C cSt 100°C cSt (IP 71/ASTM-D445)	189 15.6	189 15.6	189 15.6	189 15.6	189 15.6
Dropping Point °C (IP 132)	-	-	180	180	180
Cone Penetration Worked @ 25°C 0.1mm (IP 50/ASTM-D217)	400-480	355-385	310-340	265-295	220-250

These characteristics are typical of current production. Whilst future production will conform to Shell's specification, variations in these characteristics may occur.

October 2007

2/2

Version 2

Doc. Title	Ship Information Handbook		186 / 226
Doc. Reference	23,3 m Trawler		
Doc. Revision & Date	A - 15/09/14		

## Shell Tivela Oils W

### Synthetic Industrial gear lubricants



Shell Tivela Oils W are high performance synthetic gear lubricants with special additives to enhance their anti-oxidation and anti-corrosion characteristics.

#### Applications

- High speed/shock loaded industrial gears
- Highly loaded industrial gears
- Worm gear lubrication
- Bearing & circulation lubricants in applications such as plastic calendars where high bulk oil temperatures of up to 200°C may be experienced

*Shell Tivela Oils W are not recommended for the lubrication of gears manufactured from bronze alloys containing aluminium*

#### Performance Features

- **Extremely high viscosity index**  
A natural feature providing high shear stability without the need for viscosity index improvers. Stays in grade in the most arduous conditions.
- **Low pour point**  
Effective lubrication at low start-up temperatures
- **High load-carrying capacity**  
Maintains a fluid film between working surfaces in conditions of high load and shock
- **Exceptional low frictional characteristics**  
For efficient power transmission
- **High oxidation & thermal stability**  
Resistant to the formation of the harmful products of oxidation
- **Excellent steel-on-steel scuffing protection and steel-on-bronze anti-wear characteristics**  
For reliable trouble free performance

#### Advice

Advice on applications not covered in this leaflet may be obtained from your Shell Representative

#### Typical Physical Characteristics

S003IYPW.00E 0896

Shell Tivela Oil	WA	WB
ISO Viscosity Grade	150	220
Kinematic Viscosity @ 40°C cSt	147	234
100°C cSt (IP 71)	24.5	35
Viscosity Index (IP 228)	200	200
Density @ 15°C kg/l (IP 365)	1.025	1.026
Flash Point °C (Open Cup)	277	321
Pour Point °C (IP 15)	-33	-33

These characteristics are typical of current production. Whilst future production will conform to Shell's specification, variations in these characteristics may occur.

#### Health & Safety

Shell Tivela Oils W are unlikely to present any significant health or safety hazard when properly used in the recommended application, and good standards of industrial and personal hygiene are maintained.

Avoid contact with skin. Use impervious gloves with used oil. After skin contact, wash immediately with soap and water.

For further guidance on Product Health & Safety refer to the appropriate Shell Product Safety Data Sheet.

#### Protect the environment

Take used oil to an authorised collection point. Do not discharge into drains, soil or water.

Doc. Title	Ship Information Handbook		187 / 226
Doc. Reference	23,3 m Trawler		
Doc. Revision & Date	A - 15/09/14		

## 6-9-9. Axal Salt Tablets



## Product data sheet

## AXAL® PRO SALT TABLETS

Pure dried vacuum salt



Version 5.0

Page 1 / 2

printing date 5.03.2013

CAS-No.: 7647-14-5

EINECS-No.: 231-598-3

## Appearance

Totally soluble PDV salt tablets

## Chemical Analysis

- Sodium chloride
- Calcium + Magnesium
- Sulphate
- H<sub>2</sub>O-insoluble
- Moisture
- Arsenic
- Cadmium
- Chromium
- Mercury
- Nickel
- Lead
- Antimony
- Selenium
- Copper
- Iron
- Manganese

## Specification

Specification	Typical	Methods
> 99,9 %	99,93 %	EN 973
< 0,01 %	0,004 %	ISO 2482
< 0,1 %	0,04 %	ISO 2480
< 0,01 %	0,005 %	ISO 2479
< 0,1 %	0,02 %	ISO 2483
< 0,3 mg/kg	< 0,1 mg/kg	EN 973
< 0,5 mg/kg	< 0,1 mg/kg	EN 973
< 0,75 mg/kg	< 0,1 mg/kg	EN 973
< 0,05 mg/kg	< 0,02 mg/kg	EN 973
< 0,75 mg/kg	< 0,1 mg/kg	EN 973
< 2 mg/kg	< 0,5 mg/kg	EN 973
< 2,6 mg/kg	< 0,1 mg/kg	EN 973
< 2,6 mg/kg	< 0,1 mg/kg	EN 973
< 2 mg/kg	< 0,1 mg/kg	EuSalt AS 015
< 2 mg/kg	< 1 mg/kg	EuSalt AS 015
< 1 mg/kg	< 0,1 mg/kg	EuSalt AS 015

## Physical Properties

- Bulk density

ca. 1.000 kg/m<sup>3</sup>

## Methods

EN 1236

## Note

Specifications are based on requirements of NF, EN 973, EN 14805 and Codex Alimentarius. Typical values are based on regular analysis.

## Dimensions

Diameter: 25 mm Height: appr. 16 mm Weight: appr. 15 g

## Granulometry

Fines &lt; 5.0 mm max. 4.0 % typical: 2 % Method: EN 1235

## Note

The tablets are produced from refined food grade salt which complies with the purity criterion of the Codex Alimentarius.

This product is in compliance with EN-973(A): regenerating salt for ion exchangers and EN 14805 type 1: Chemicals used for treatment of water intended for human consumption – Sodium chloride for on site electrochlorination using non-membrane technology.

The preceding data result from our quality control. They do not release the user from a control on entry and are not meant to guarantee the properties. The qualification of the product for a certain application has to be checked by the customer.

esco - european salt company GmbH & Co.KG  
 Headquarters • Landschaftstraße 1 • 30159 • Hannover • Germany • ☎ +49-(0)511-85030-0 • ...-131  
 esco benelux nv • Park Lane, Culliganlaan 26 bus 1 • B-1831 • Diegem • Belgium • ☎ +32-2711-0160 • ...-0161  
 esco france s.a.s • 49 Avenue Georges Pompidou • F-92593 • Levallois-Perret Cedex • France • ☎ +33(0)1.49.64.59.00 • ...1.49.64.59.10  
 Vatel S.A. • Apartado 211-Sobralinho • P-2616-956 • Alverca • Portugal • ☎ +35-1219-5184-20 • ...-39  
 esco Spain S.L. • Joan d'Austria, 39-47 • 08005 • Barcelona • Spain • ☎ +34 (93) 2247238 • +34 (93) 2214193  
 esco Nordic AB • Drakegatan 10 • 401 23 • Göteborg • Sweden • ☎ +46 -31 773 70- 01 • ...-02  
 www.esco-salt.com Certification according to EN ISO 9001:2008

Doc. Title	Ship Information Handbook		188 / 226
Doc. Reference	23,3 m Trawler		
Doc. Revision & Date	A - 15/09/14		



## Product data sheet

### AXAL® PRO SALT TABLETS

Pure dried vacuum salt



Version 5.0

Page 2 / 2

printing date 5.03.2013

Tablets produced in Borth, Dombasle and Harlingen are in compliance with the NF mark for water treatment devices: regenerating salts for water softeners.

#### Field of application

For industrial uses.

AXAL® PRO tablets are specially produced to obtain a very pure brine for regeneration of ion exchange resins in water softeners.

#### Production process

AXAL® PRO tablets are obtained by very high mechanical pressure, without anticaking agent.

#### Storage

Handling and storage should be ensured under proper hygiene and preservation conditions so as to exclude any risk of contamination. Do not stack up more than 3 pallets.

#### Safety

A safety data sheet on SODIUM CHLORIDE can be obtained from esco on request. Sodium chloride is exempt from the REACH registration requirement because it is a natural mineral.

#### Supply Data

- 25-kg-PE-bags on pallet
- Other delivery forms on request

The preceding data result from our quality control. They do not release the user from a control on entry and are not meant to guarantee the properties. The qualification of the product for a certain application has to be checked by the customer.

esco - european salt company GmbH & Co.KG  
 Headquarters • Landschaftstraße 1 • 30159 • Hannover • Germany • ☎ +49-(0)511-85030-0 ☎ ...-131  
 esco benelux nv • Park Lane, Culliganlaan 2G bus 1 • B-1831 • Diegem • Belgium • ☎ +32-2711-0160 ☎ ...-0161  
 esco france s.a.s • 49 Avenue Georges Pompidou • F-92593 • Levallois-Perret Cedex • France • ☎ +33(0)1.49.64.59.00 ☎ ...1.49.64.59.10  
 Vatel S.A. • Apartado 211-Sobralinho • P-2616-956 • Alverca • Portugal • ☎ +35-1219-5184-20 ☎ ...-39  
 esco Spain S.L • Joan d'Austria, 39-47 • 08005 • Barcelona • Spain • ☎ +34 (93) 2247238 ☎ +34 (93) 2214193  
 esco Nordic AB • Drakegatan 10 • 401 23 • Göteborg • Sweden • ☎ +46 -31 773 70- 01 ☎ ...-02  
[www.esco-salt.com](http://www.esco-salt.com) Certification according to EN ISO 9001:2008

Doc. Title	Ship Information Handbook		189 / 226
Doc. Reference	23,3 m Trawler		
Doc. Revision & Date	A - 15/09/14		

## CHAPTER 7 – FIGURES

---

Doc. Title	Ship Information Handbook		190 / 226
Doc. Reference	23,3 m Trawler		
Doc. Revision & Date	A - 15/09/14		

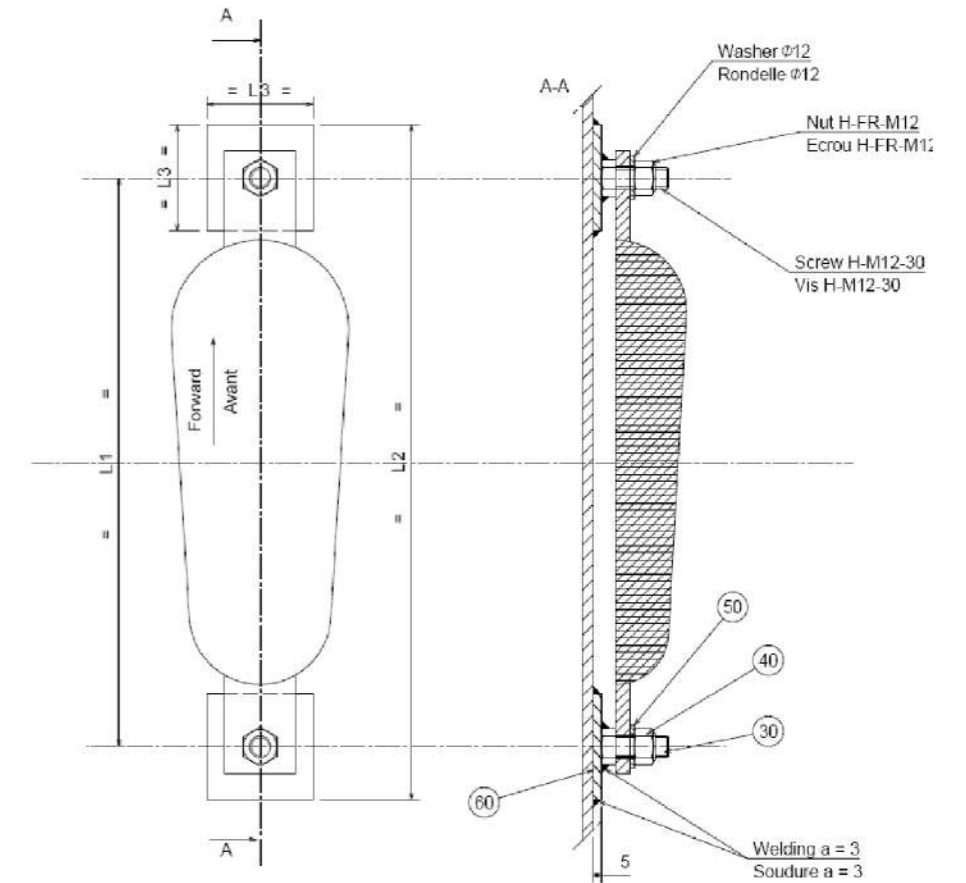
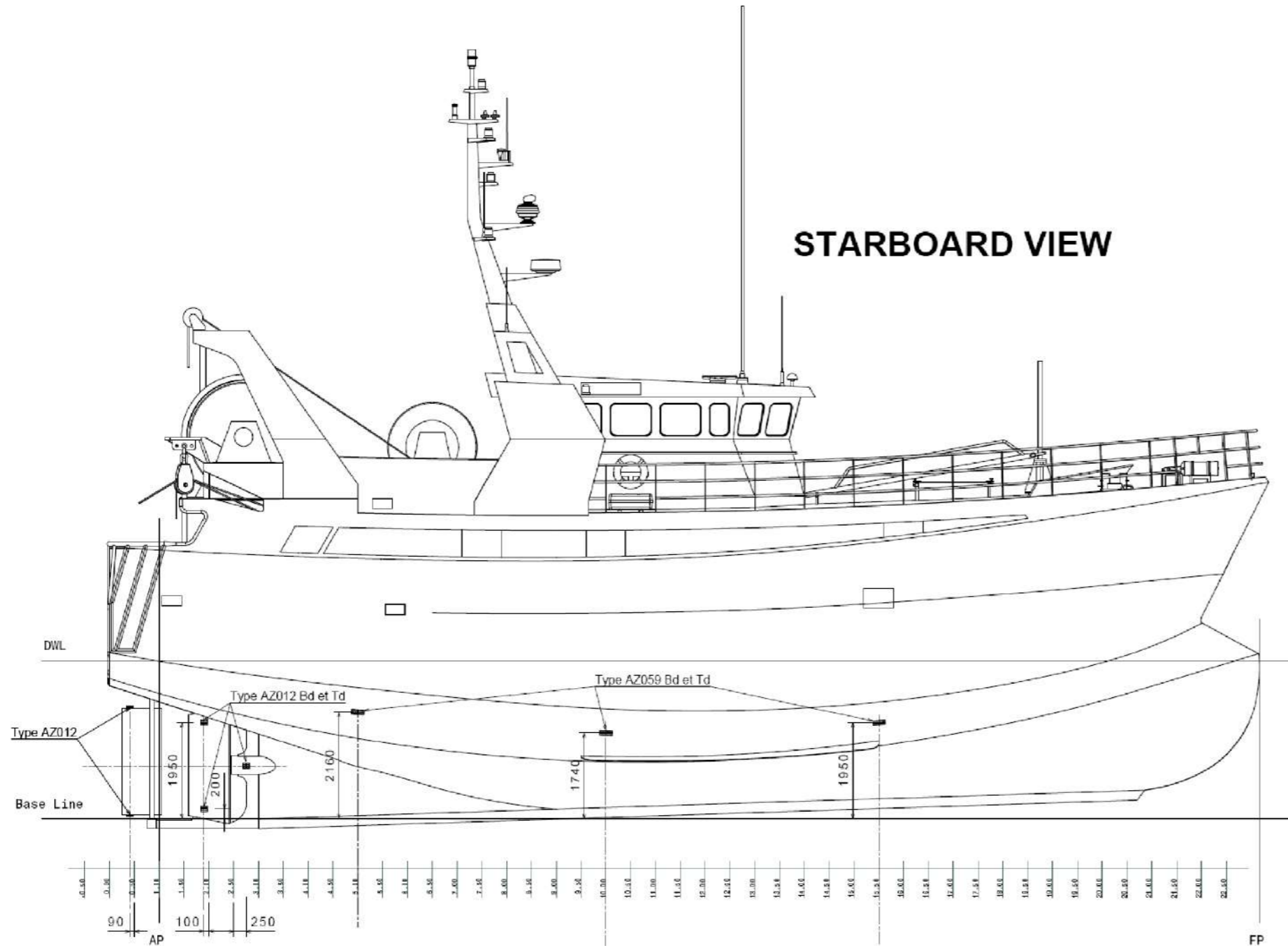

AZ012 - Qty / Nb: 8  
Weight / poids: 1,2 Kg

AZ059 - Qty / Nb: 6  
Weight / poids: 5,9 Kg

	L1 (mm)	L2 (mm)	L3 (mm)
10 AZ012	160	200	40
20 AZ059	320	360	60

Note : Torque tightening = 48 N.m  
Couple de serrage = 48 N.m

Doc. Title	Ship Information Handbook		191 / 226
Doc. Reference	23,3 m Trawler		
Doc. Revision & Date	A - 15/09/14		

© CMN group all rights reserved

Figure 7-1 Hull Corrosion Protection System

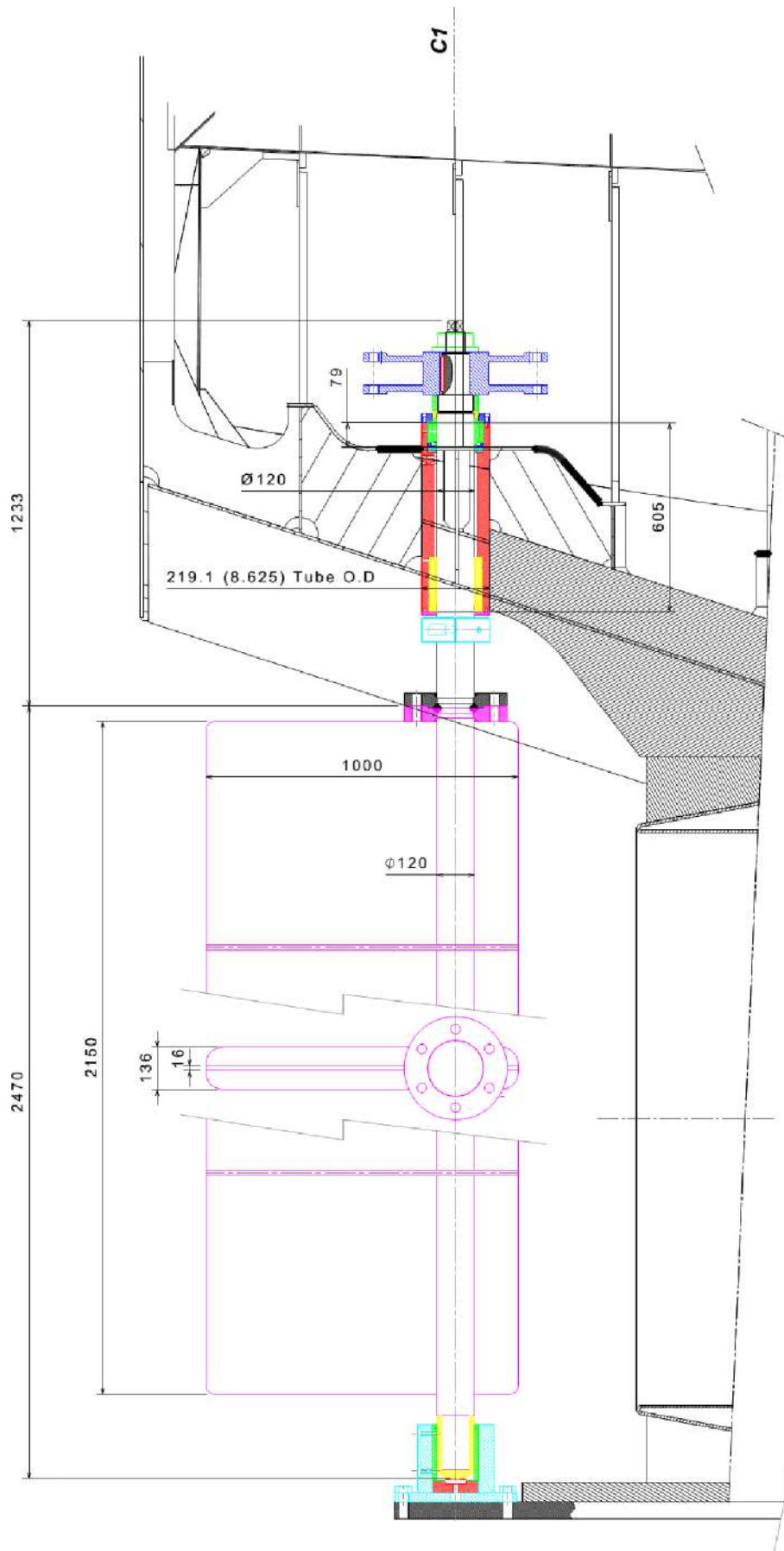

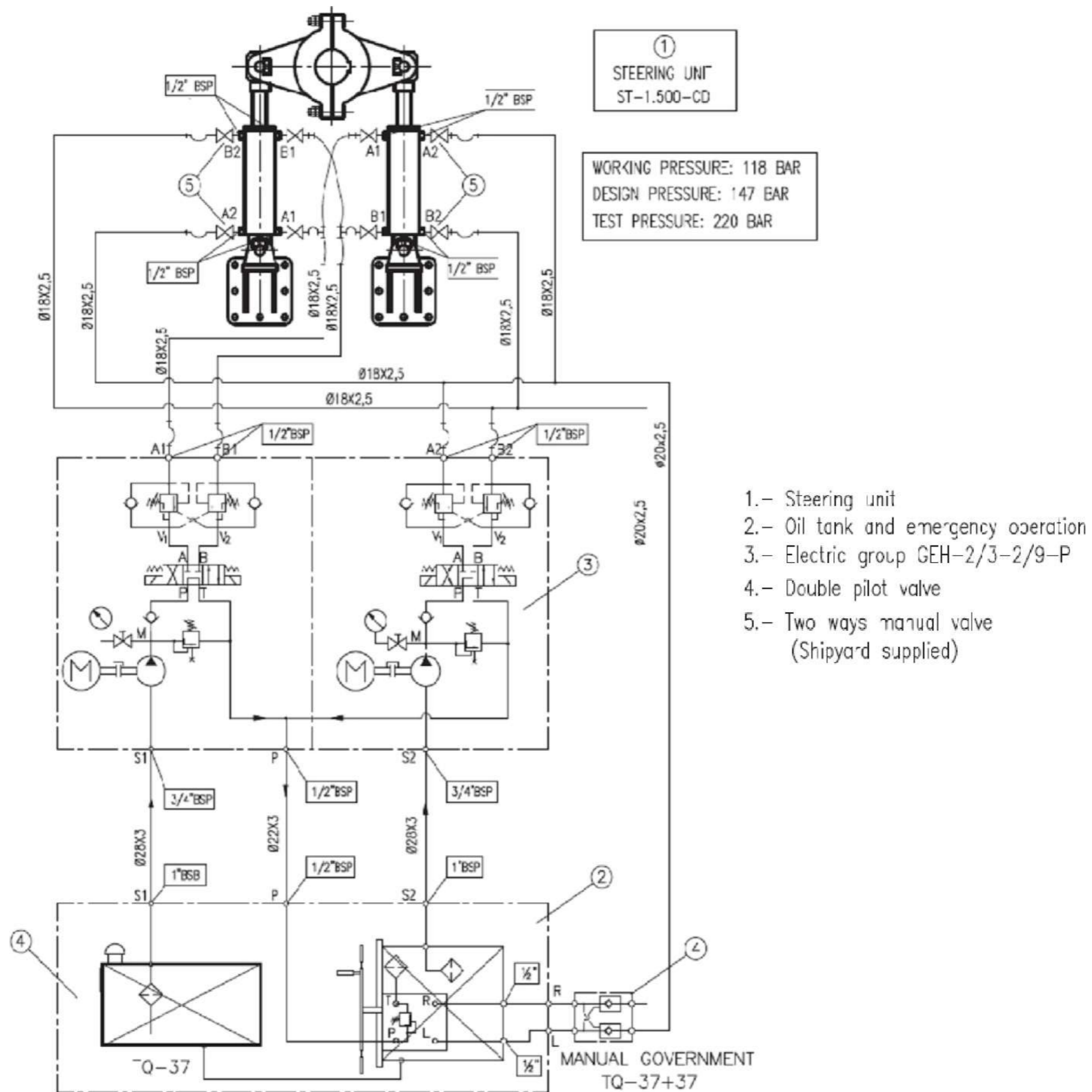

Figure 7-2 Rudder Stock

Doc. Title	Ship Information Handbook		192 / 226
Doc. Reference	23,3 m Trawler		
Doc. Revision & Date	A - 15/09/14		





①  
STEERING UNIT  
ST-1.500-CD

WORKING PRESSURE: 118 BAR  
DESIGN PRESSURE: 147 BAR  
TEST PRESSURE: 220 BAR

- 1.- Steering unit
- 2.- Oil tank and emergency operation
- 3.- Electric group GEH-2/3-2/9-P
- 4.- Double pilot valve
- 5.- Two ways manual valve  
(Shipyard supplied)



Doc. Title	Ship Information Handbook		193 / 226
Doc. Reference	23,3 m Trawler		
Doc. Revision & Date	A - 15/09/14		

Figure 7-3 Steering Gear System

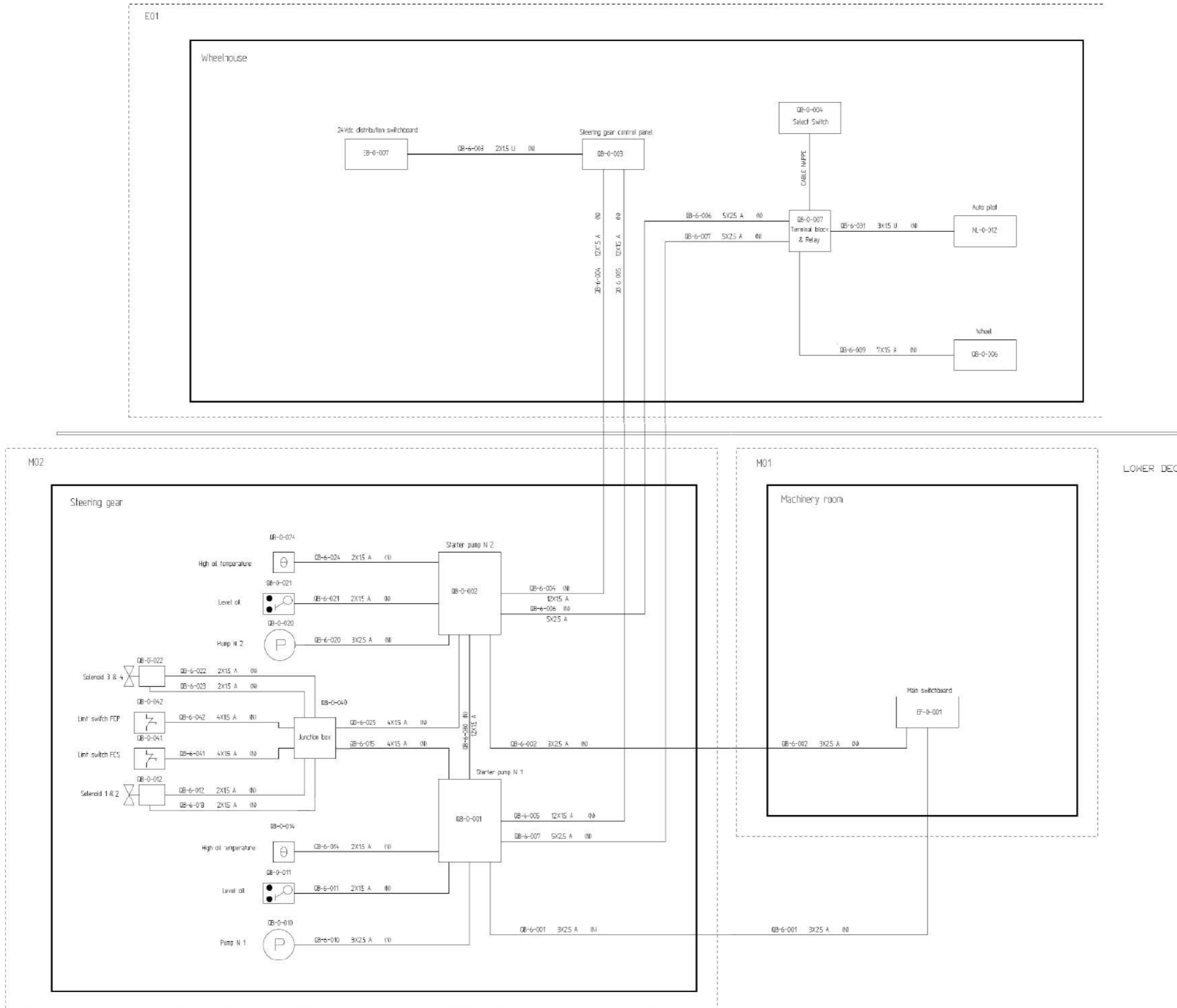

Doc. Title	Ship Information Handbook		194 / 226
Doc. Reference	23,3 m Trawler		
Doc. Revision & Date	A - 15/09/14		

© CMN group all rights reserved

Figure 7-4 Steering Gear Network

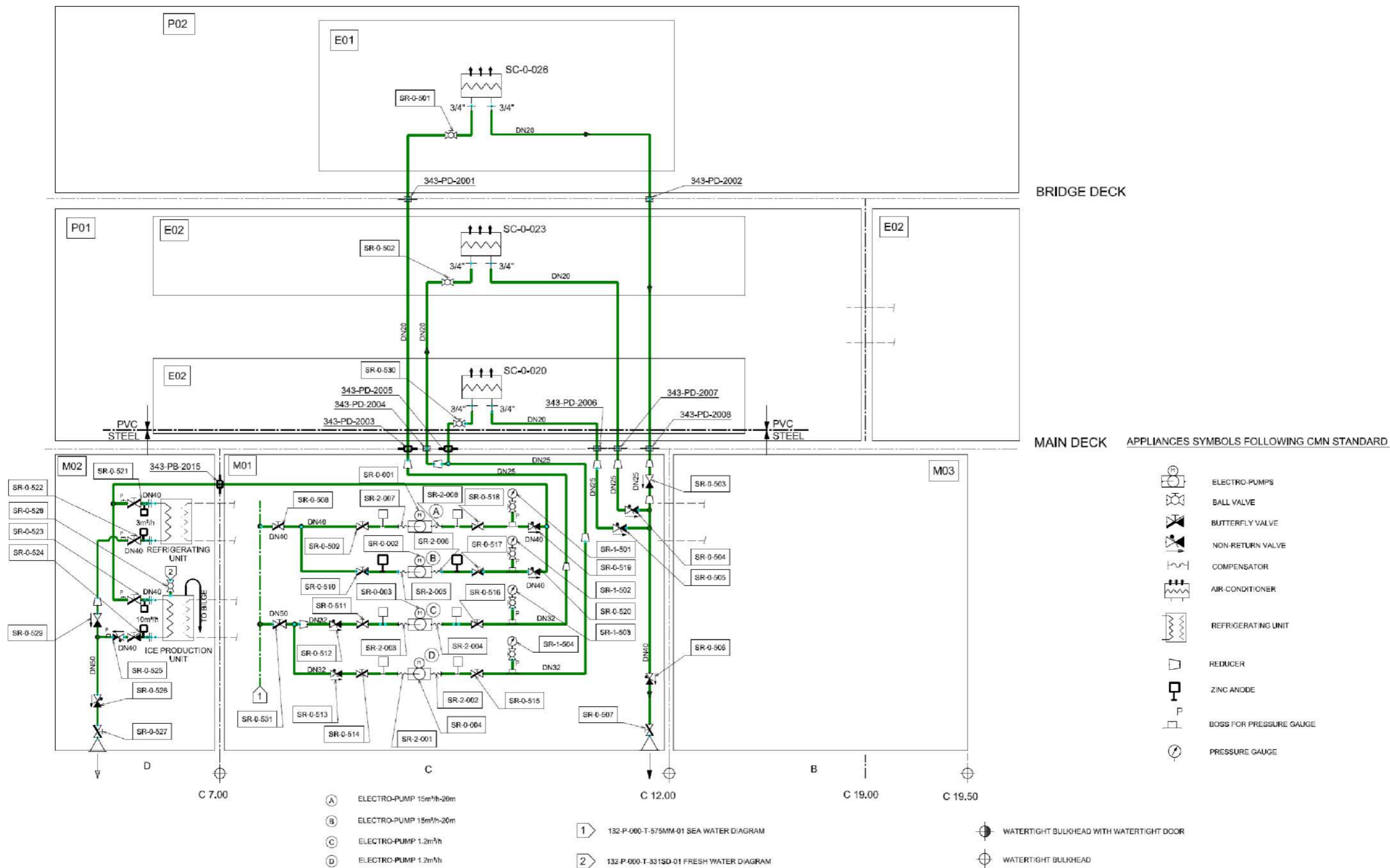

Doc. Title	Ship Information Handbook		195 / 226
Doc. Reference	23,3 m Trawler		
Doc. Revision & Date	A - 15/09/14		

© CMN group all rights reserved

Figure 7-5 AC Sea Water Cooling System

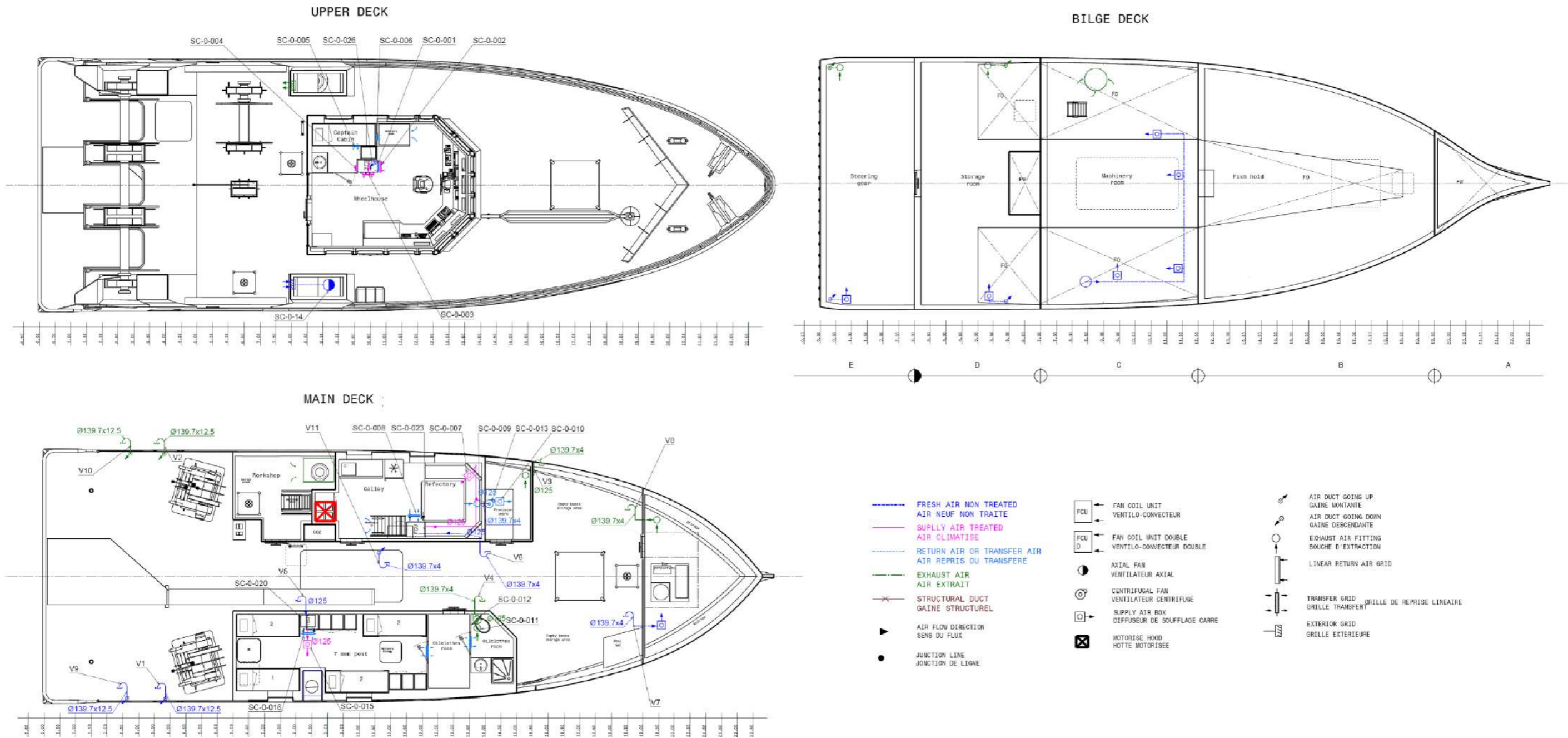



Figure 7-6 HVAC System

Doc. Title	Ship Information Handbook		196 / 226
Doc. Reference	23,3 m Trawler		
Doc. Revision & Date	A - 15/09/14		

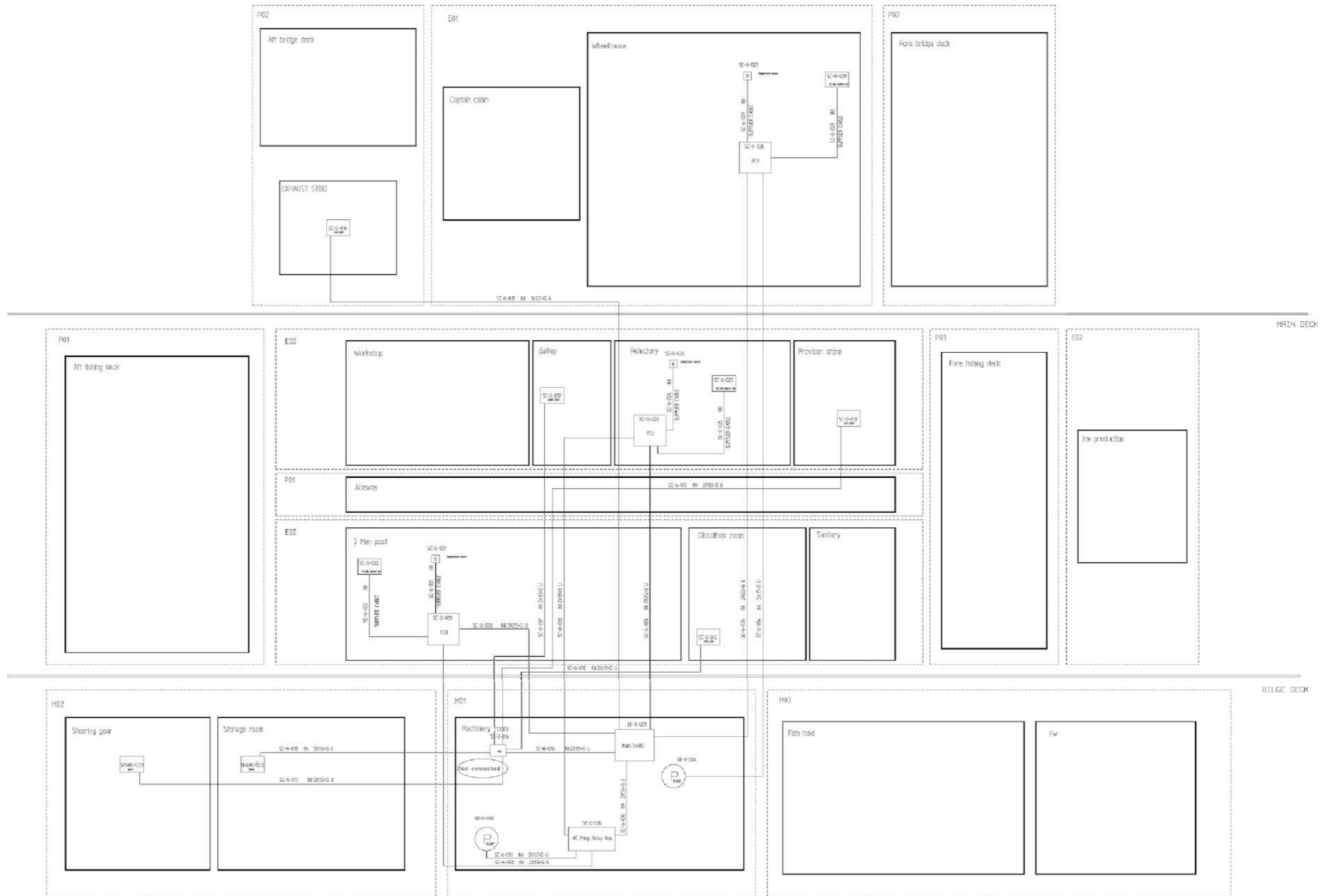

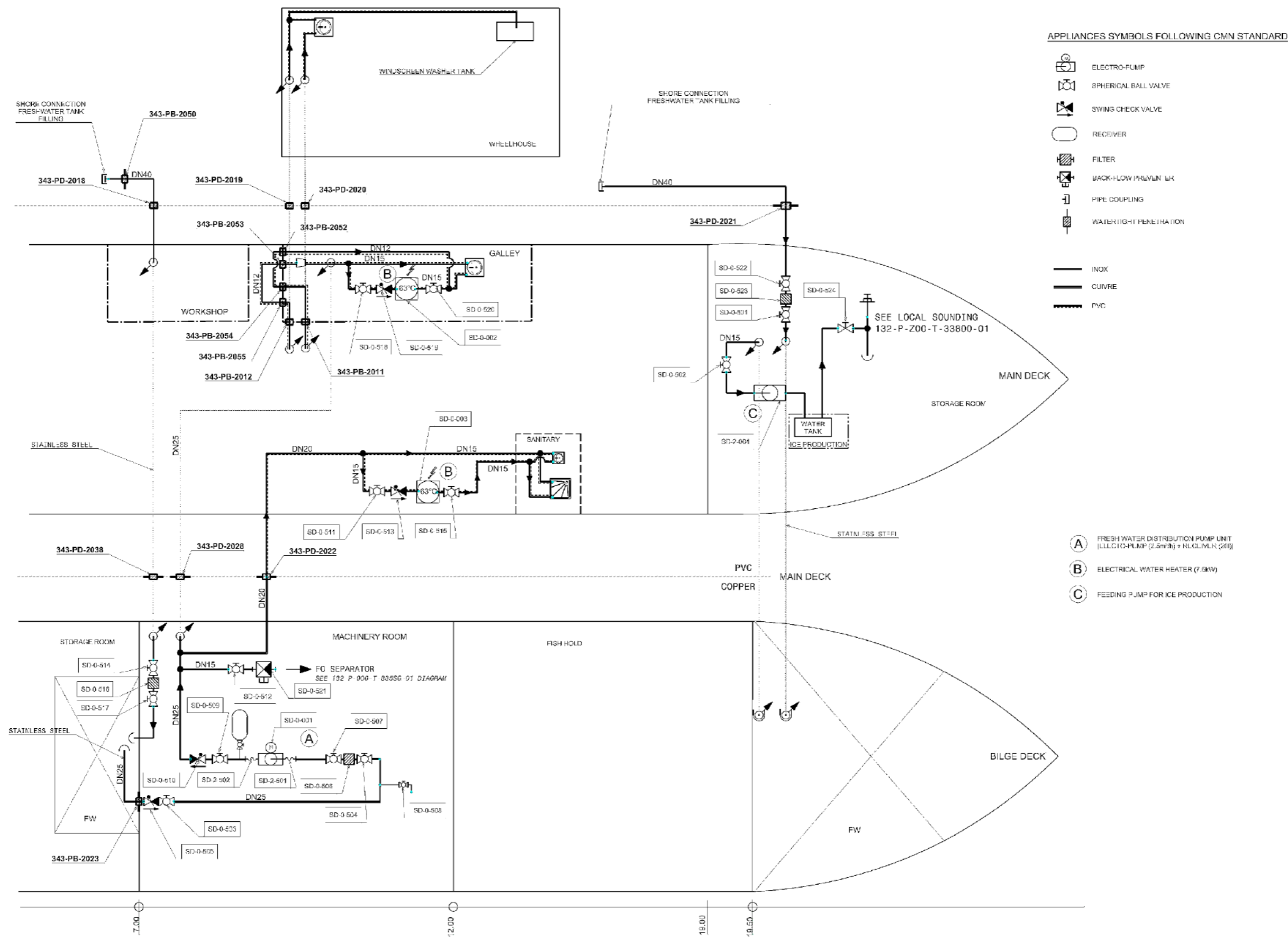



Figure 7-7 HVAC Electrical Network

Doc. Title	Ship Information Handbook		197 / 226
Doc. Reference	23,3 m Trawler		
Doc. Revision & Date	A - 15/09/14		





- (A) FRESH WATER DISTRIBUTION PUMP UNIT (LULLOIC-PUMP (2.5m³/h) + RECUMYL (200))
- (B) ELECTRICAL WATER HEATER (7.5kW)
- (C) FEEDING PUMP FOR ICE PRODUCTION

Doc. Title	Ship Information Handbook		198 / 226
Doc. Reference	23,3 m Trawler		
Doc. Revision & Date	A - 15/09/14		

© CMN group all rights reserved

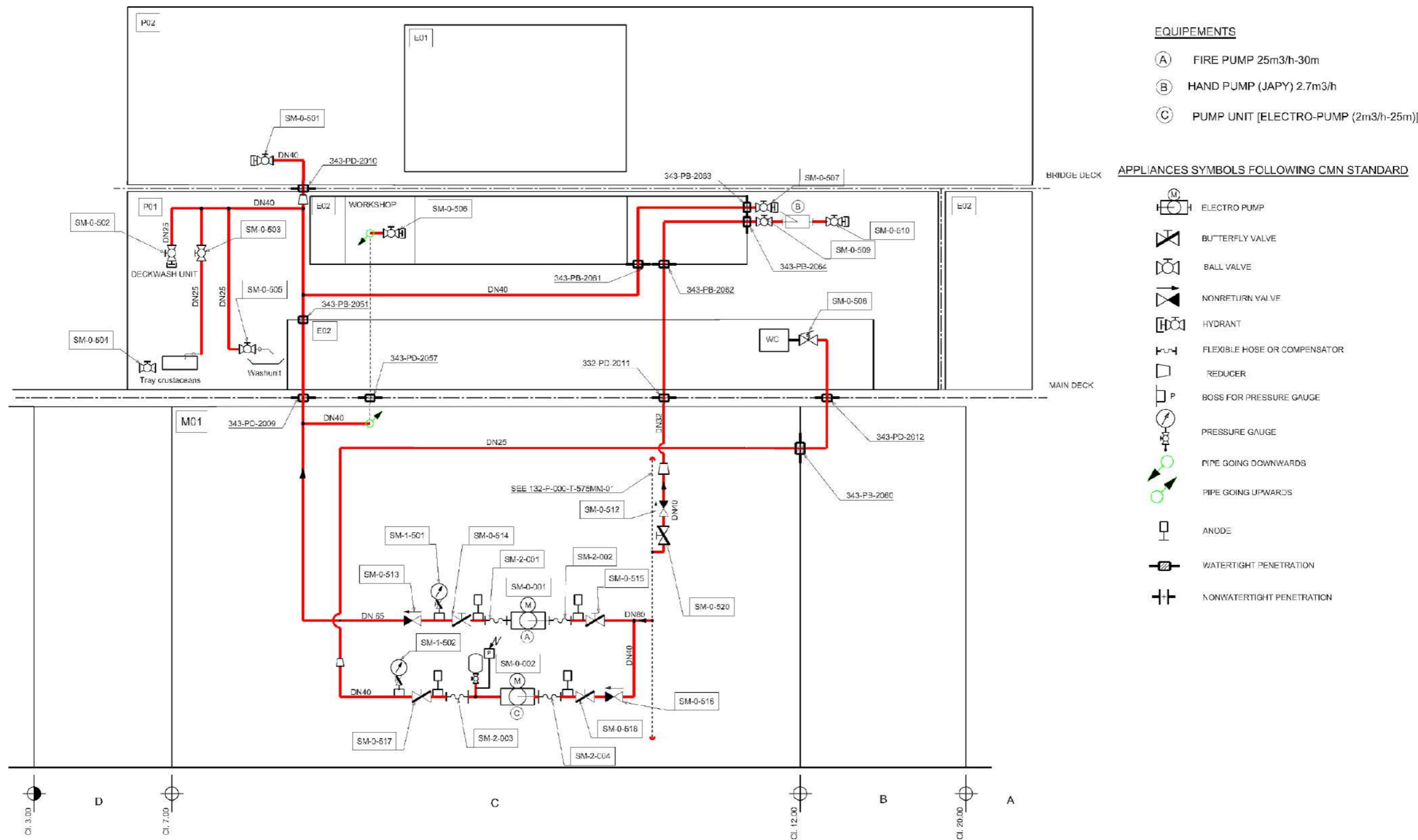
Figure 7-8 Fresh Water System



Doc. Title	Ship Information Handbook		199 / 226
Doc. Reference	23,3 m Trawler		
Doc. Revision & Date	A - 15/09/14		

© CMN group all rights reserved

Figure 7-9 Firemain System

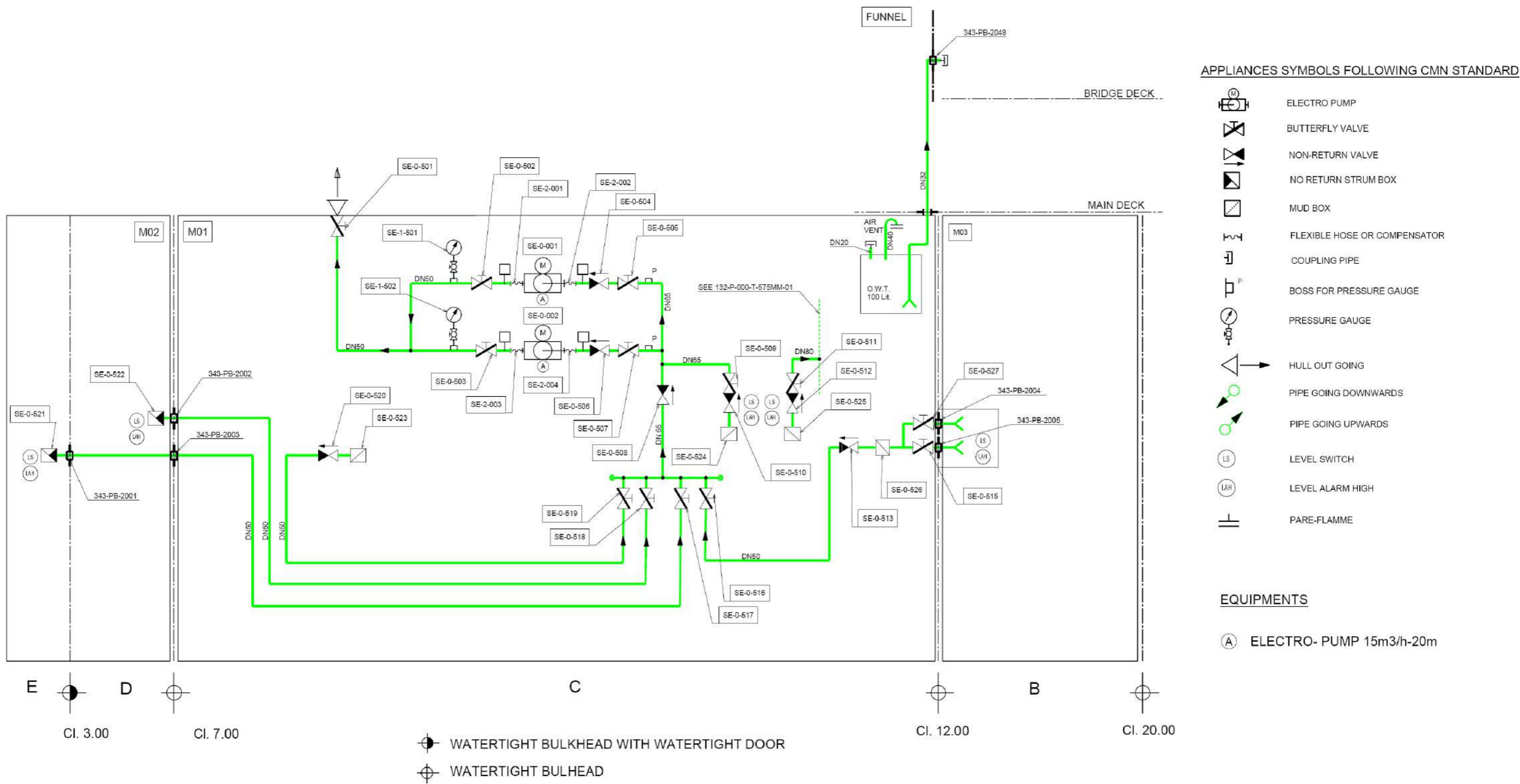



Doc. Title	Ship Information Handbook		200 / 226
Doc. Reference	23,3 m Trawler		
Doc. Revision & Date	A - 15/09/14		

© CMN group all rights reserved

Figure 7-10 Bilge System

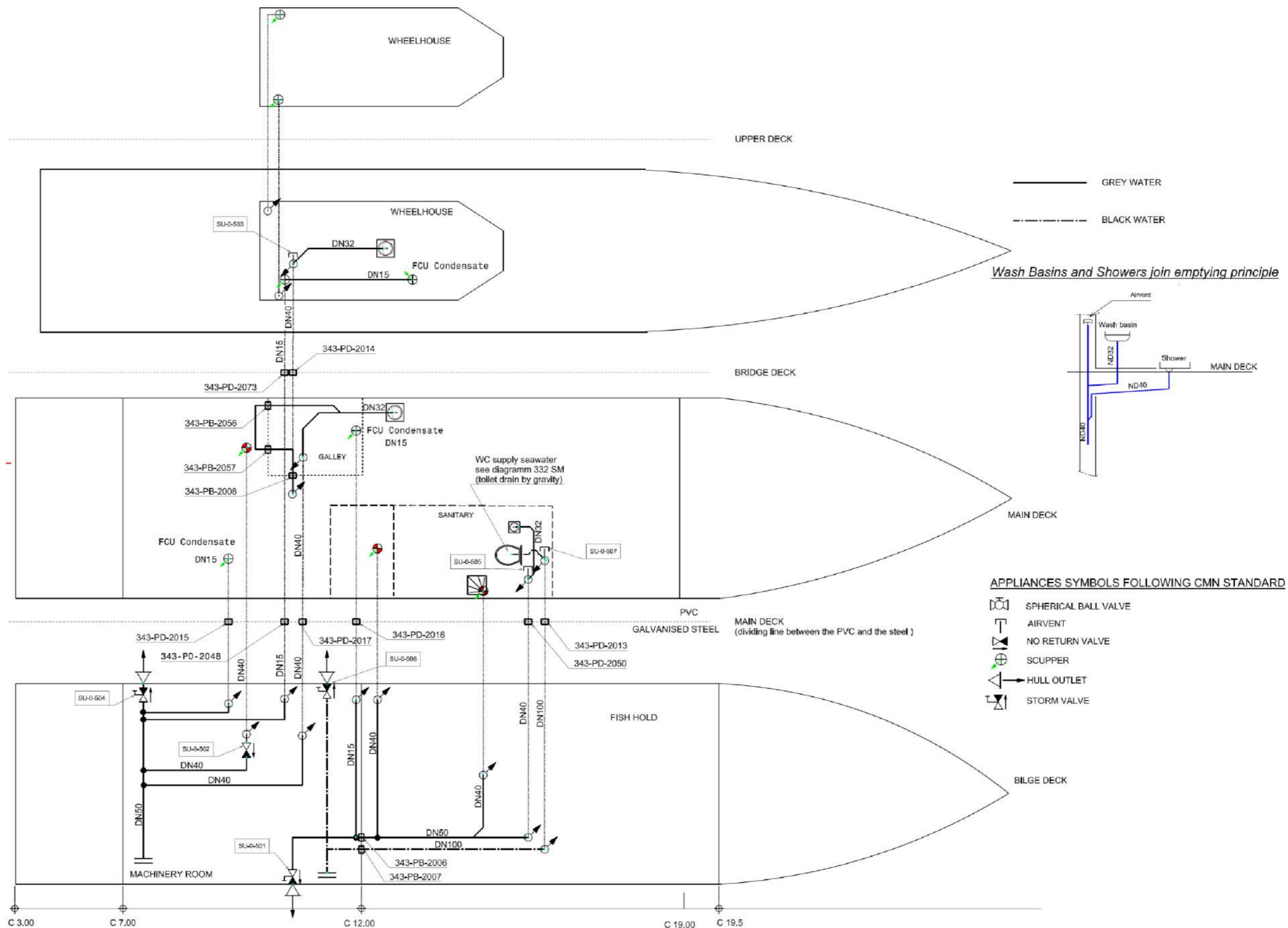



Doc. Title	Ship Information Handbook		201 / 226
Doc. Reference	23,3 m Trawler		
Doc. Revision & Date	A - 15/09/14		

© CMN group all rights reserved

Figure 7-11 Sewage System

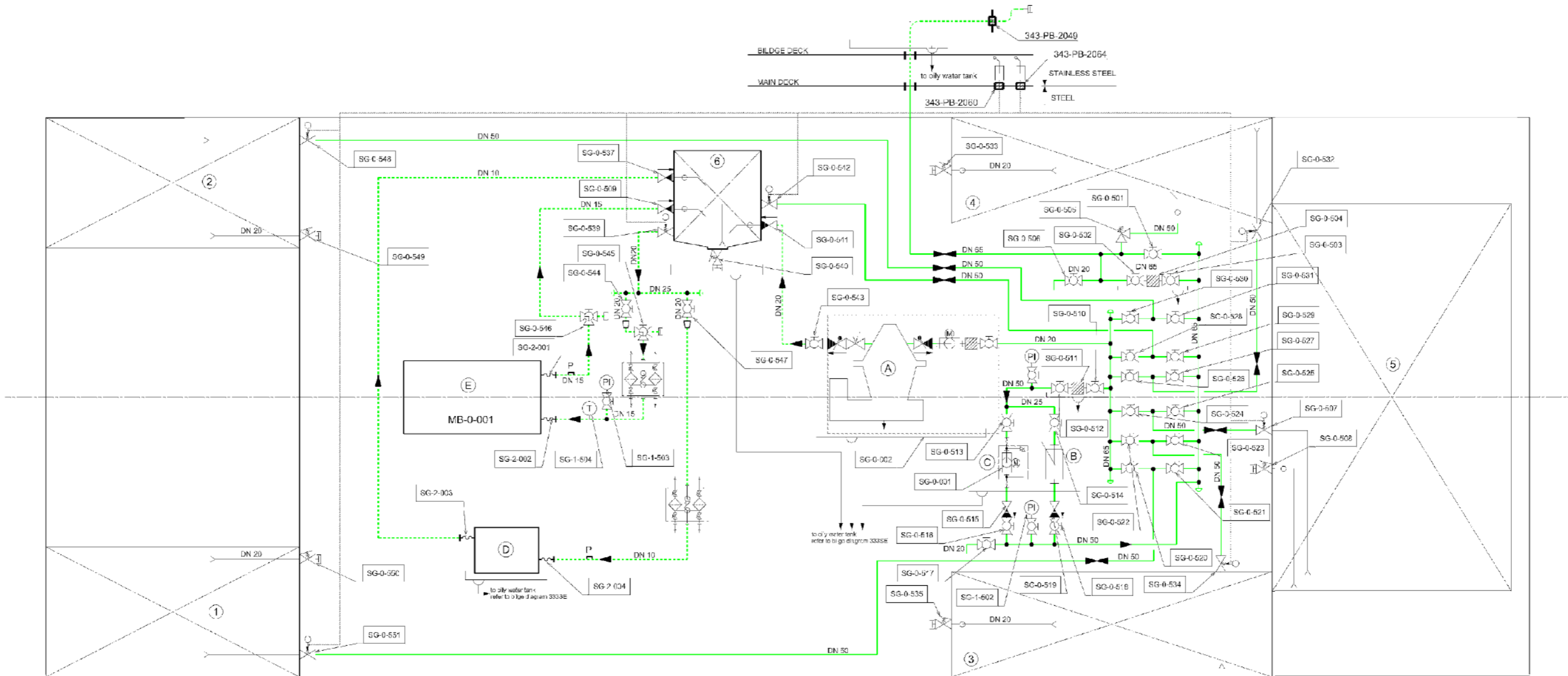

**EQUIPMENT :**

- (A) SEPARATOR 0.8 m<sup>3</sup>/h
- (B) HAND-PUMP 2 m<sup>3</sup>/h
- (C) TRANSFER ELECTRO-PUMP DE 10m<sup>3</sup>/h
- (D) GENERATOR SET
- (E) MAIN ENGINE

**TANKS :**

- ① FUEL-OIL STORAGE TANK
- ② FUEL-OIL STORAGE TANK
- ③ FUEL-OIL STORAGE/OVERFLOW TANK
- ④ FUEL-OIL STORAGE/OVERFLOW TANK
- ⑤ FUEL-OIL STORAGE TANK
- ⑥ FUEL-OIL SERVICE TANK

**APPLIANCES SYMBOLS FOLLOWING CMN STANDARD**

- SPHERICAL BALL VALVE
- NO RETURN VALVE
- BUTTERFLY VALVE
- FLEXIBLE HOSE OR COMPENSATOR
- GLOBE VALVE SELF CLOSING
- PIPE COUPLING
- FILTER
- ELECTROPUMP
- ANGLE RELIEF VALVE
- HYDRAULIC ACTUATOR
- PRESSURE GAUGE
- HYDRAULIC CONTROLLED QUICK CLOSING VALVE
- HAND PUMP





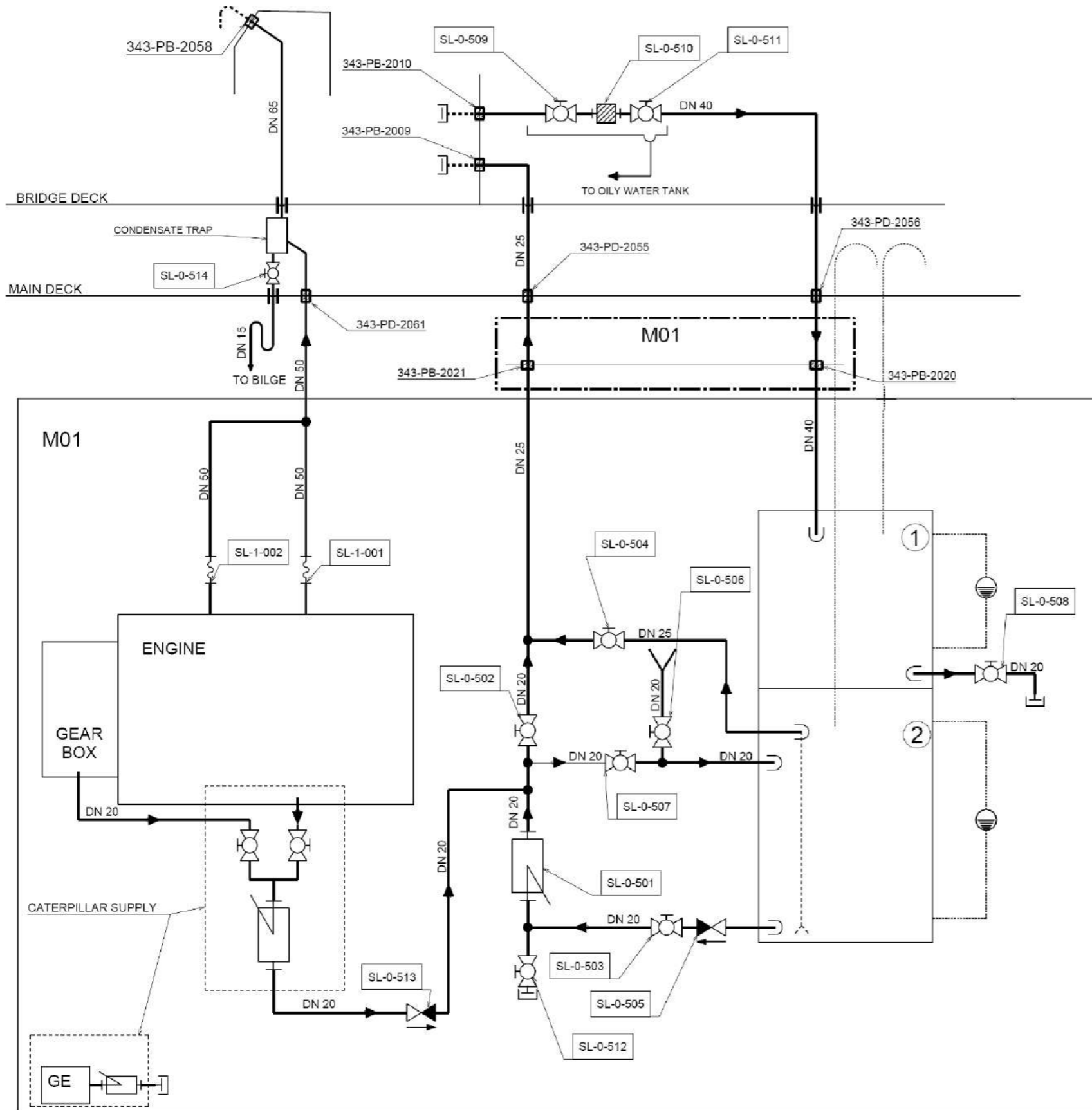

Doc. Title	Ship Information Handbook		202 / 226
Doc. Reference	23,3 m Trawler		
Doc. Revision & Date	A - 15/09/14		

© CMN group all rights reserved



Figure 7-12 Marine Fuel Oil System



**APPLIANCES SYMBOLS FOLLOWING CMN STANDARD**

-  SPHERICAL BALL VALVE
-  NO RETURN VALVE
-  FLEXIBLE HOSE OR COMPENSATOR
-  GLOBE VALVE SELF CLOSING
-  PIPE COUPLING
-  HAND PUMP
-  FILTER

**PIPE FOLLOWING STANDARDS:**  
 STEEL NFA 49-112  
 STAINLESS STEEL (316L) NFA 49-117

-  STAINLESS STEEL
-  STEEL

**TANKS :**

- ① NEW OIL TANK
- ② POLLUTED OIL TANK

**EQUIPMENT :**

- Ⓐ HAND-PUMP 1.3 m<sup>3</sup>/h

Doc. Title	Ship Information Handbook		203 / 226
Doc. Reference	23,3 m Trawler		
Doc. Revision & Date	A - 15/09/14		

Figure 7-13 Lubricating Oil System



REP	Description	Net CAPACITY
	Unit	m3
A T10	Fresh Water Tank	13.6
B T10	Fuel Oil storage Tank	8.50
C T1	Fuel Oil storage/overflow Tank	11.00
C T2	Fuel Oil storage/overflow Tank	11.00
D T10	Fresh Water Tank	3.00
D T1	Fuel Oil storage Tank	3.30
D T2	Fuel Oil storage Tank	3.30
C R1	New Oil Tank	0.7
C R2	Fuel Oil service Tank	1
C R3	Polluted Oil Tank	0.3

**APPLIANCES SYMBOLS FOLLOWING CMN STANDARD**

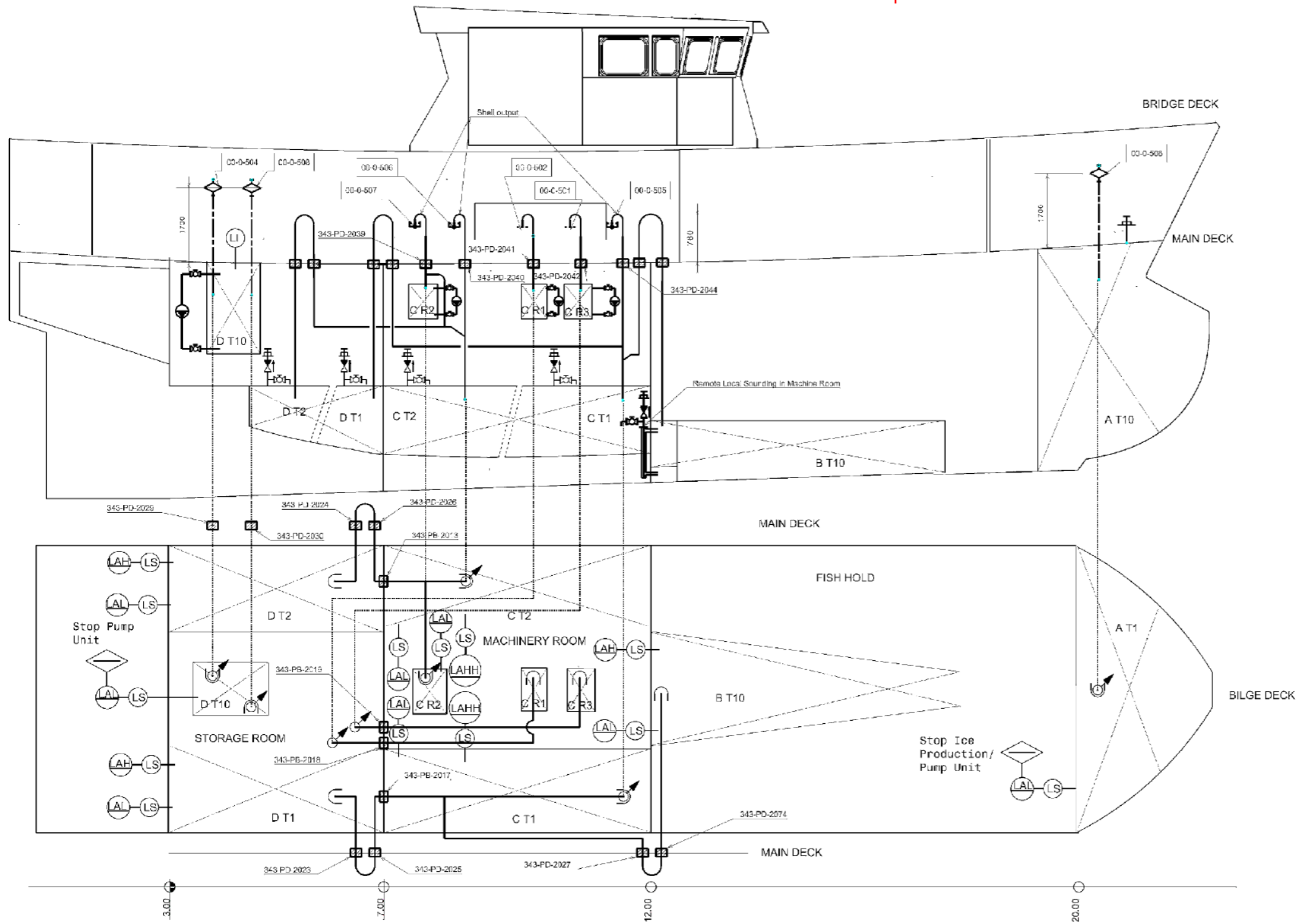
- NO RETURN VALVE
- ASEPTIC FILTER
- PIPE GOING UPWARDS
- PIPE GOING DOWNWARDS
- AIR VENT WITH AUTOMATIC CLOSING DEVICE AND FLAME ARRESTER
- AIR VALVE WITH AUTOMATIC CLOSING DEVICE
- AIR VALVE WITH FLAME ARRESTER
- LOCAL SOUNDING WITH SELF CLOSING TYPE APPLIANCE AND CHECK VALVE
- LOCAL SOUNDING
- LEVEL ALARM VERY HIGH: 97% TANK CAPACITY
- LEVEL ALARM HIGH: 90% TANK CAPACITY
- LEVEL ALARM LOW: 30% TANK CAPACITY
- LEVEL SWITCH
- LEVEL INDICATOR
- LEVEL INDICATOR
- INTERLOCK
- Steel Pipes
- Stainless Steel Pipes

Doc. Title	Ship Information Handbook		204 / 226
Doc. Reference	23,3 m Trawler		
Doc. Revision & Date	A - 15/09/14		

© CMN group all rights reserved

**Figure 7-14 Air vents, Sounding and Overflow System**

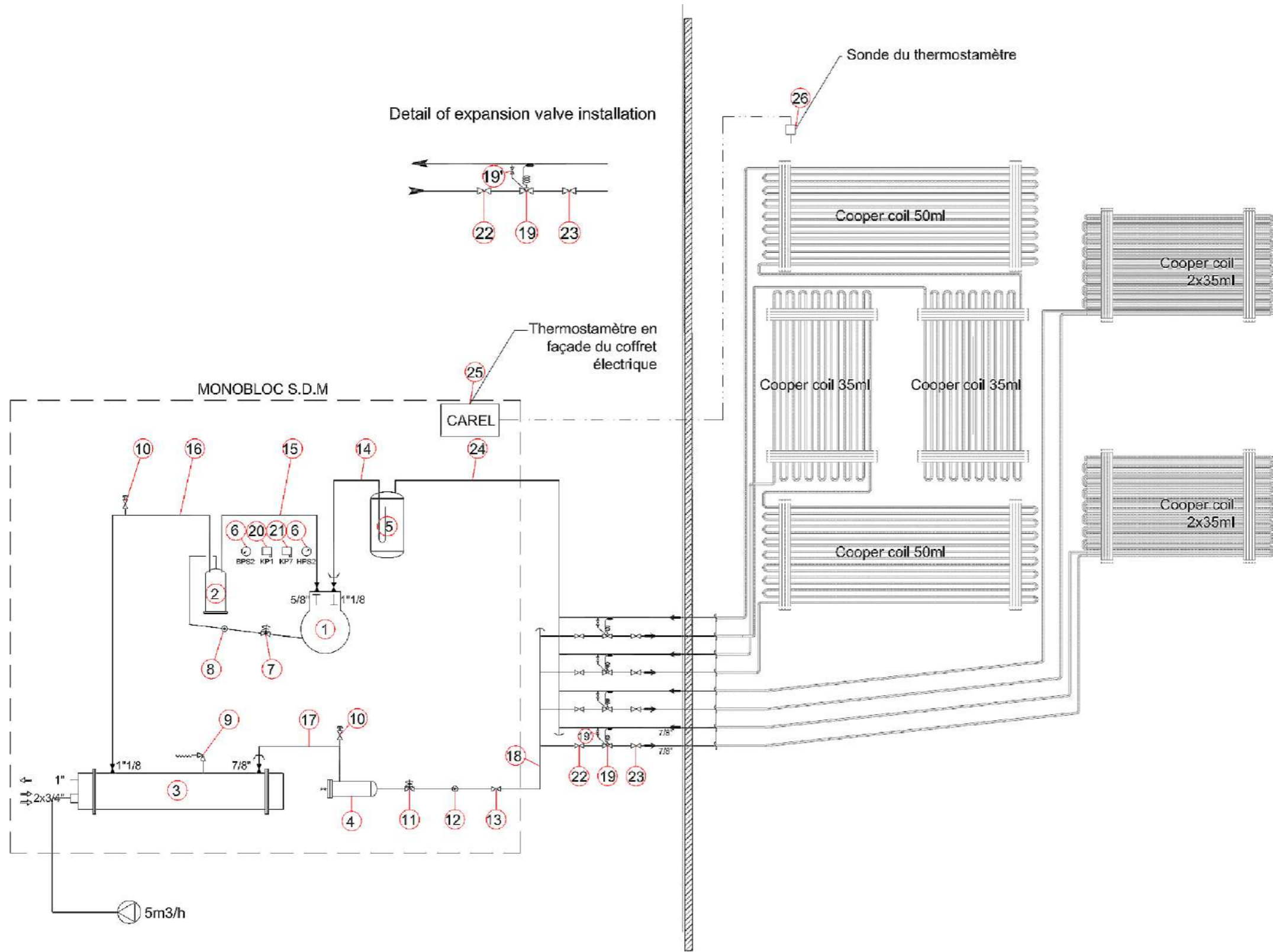



REF	DESIGNATION	QTE
1	COMPRESSOR (-17/+35°C) BITZER 4EES-4Y-40S	01
2	OIL SEPARATOR	01
3	WATER COOLED CONDENSER BITZER K 373HB-2 passes	01
4	FILTER DRIER DCR0485S	01
5	SUCTION LINE ACCUMULATOR	01
6	MANOMETER HP-BP	02
7	SOLENOIDE VALVE	01
8	SIGHT GLASSE : SGN6S	01
9	SAFETY VALVE : 526E 20.7 bars	01
10	SCHRADER VALVE 3/8" US RECO, type : 617A656	02
11	SOLENOIDE VALVE EVR10 5/8"	01
12	SIGHT GLASSE : SGN16S	01
13	BALL VALVE : GBC16S	01
14	1 1/8 Cooper tube	ml
15	5/8 Cooper tube	ml
16	1 1/8 Cooper tube	ml
17	5/8 Cooper tube	ml
18	5/8 Cooper tube	ml
19	EXPANSION VALVE TES2-0.6 solder 1/2", Orifice02	04
19'	BML6 - 1/4" flare	04
20	PRESSURE CONTROL : KP1	01
21	TEMPERATURE CONTROL : KP7	01
22	BALL VALVE : GBC10S	04
23	BALL VALVE : GBC12S	04
24	1 3/8 Cooper tube	ml
25	TEMPERATURE CONTROLLERS	01
26	TEMPERATURE SENSORS	01

Doc. Title	Ship Information Handbook		205 / 226
Doc. Reference	23,3 m Trawler		
Doc. Revision & Date	A - 15/09/14		

© CMN group all rights reserved

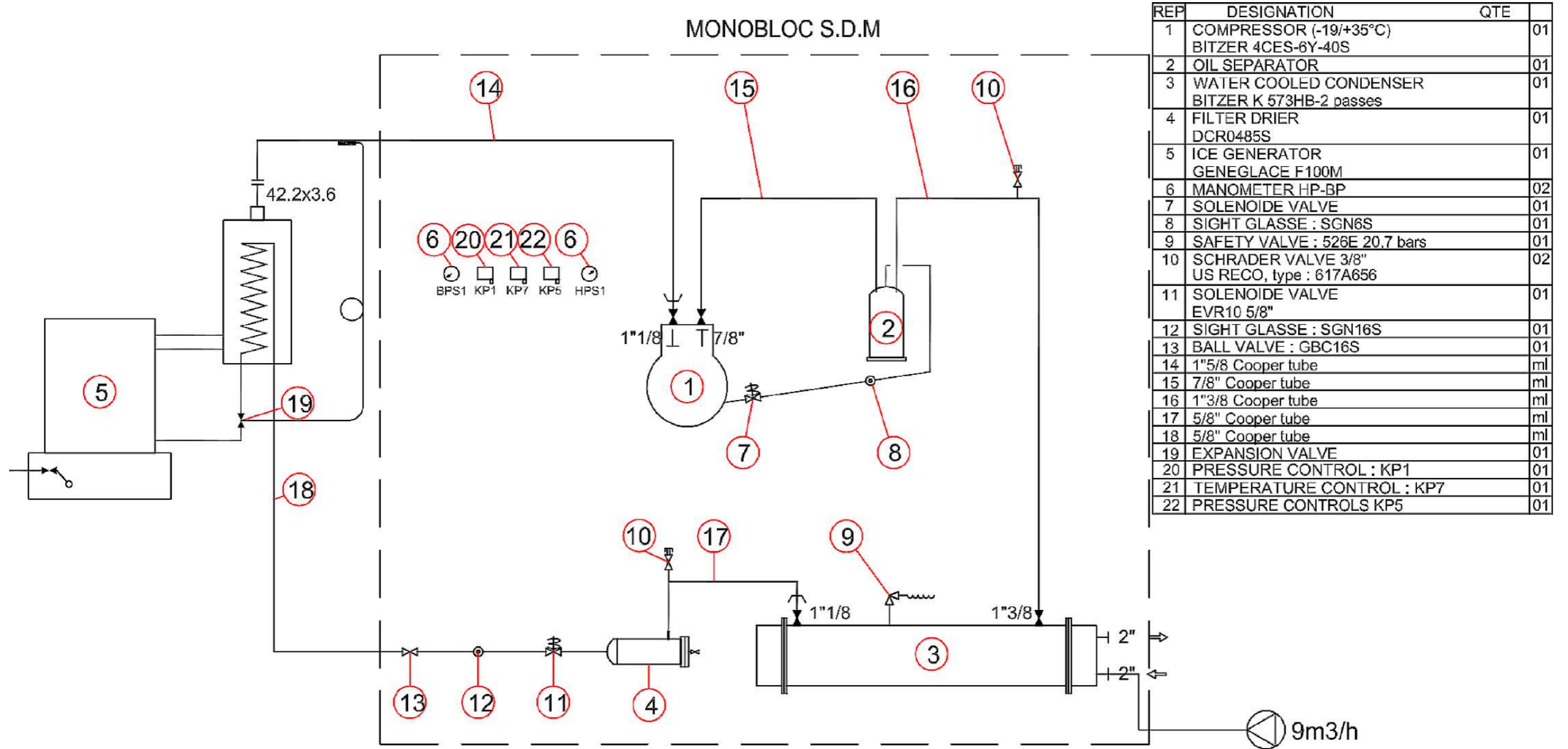
Figure 7-15 Fish Hold Refrigeration System



Doc. Title	Ship Information Handbook		206 / 226
Doc. Reference	23,3 m Trawler		
Doc. Revision & Date	A - 15/09/14		

© CMN group all rights reserved

Figure7-16 Ice Generator Refrigeration System

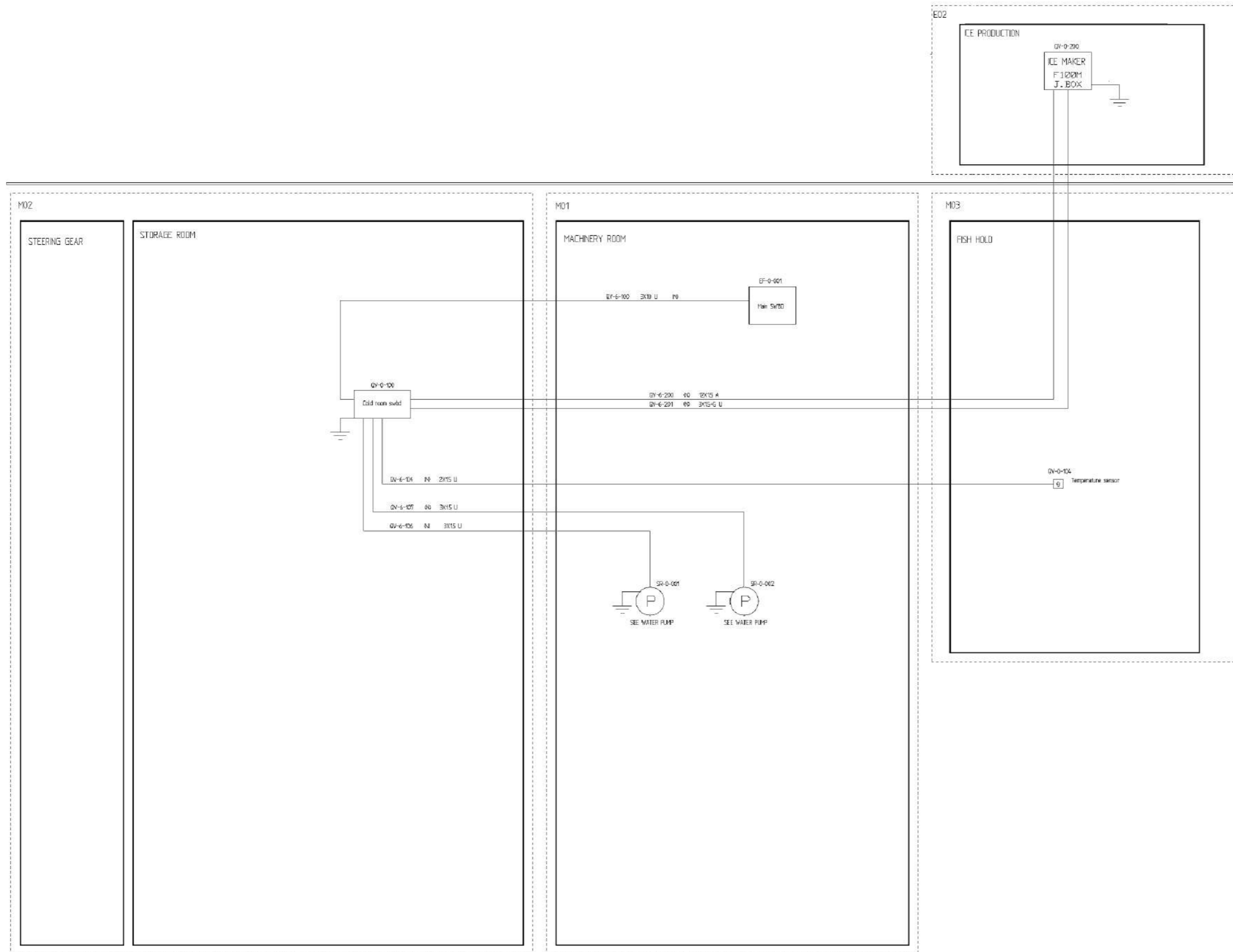

Doc. Title	Ship Information Handbook		207 / 226
Doc. Reference	23,3 m Trawler		
Doc. Revision & Date	A - 15/09/14		

© CMN group all rights reserved

Figure 7-17 Fish Hold Refrigeration Plant Electrical Network

DESIGNATION	
	SHORT CIRCUIT PROTECTIVE SYSTEM MODULE
	SMOKE OPTICAL SENSOR
	WATERTIGHT SMOKE OPTICAL SENSOR
	WATERTIGHT HEAT/SMOKE SENSOR
	NOT WATERTIGHT 54°C SENSOR
	WATERTIGHT 54°C SENSOR
	UV FLAME DETECTOR
	WATERTIGHT MANUAL CALL POINT
	NOT WATERTIGHT MANUAL CALL POINT
	SIREN + FLASHLIGHT
	SIREN

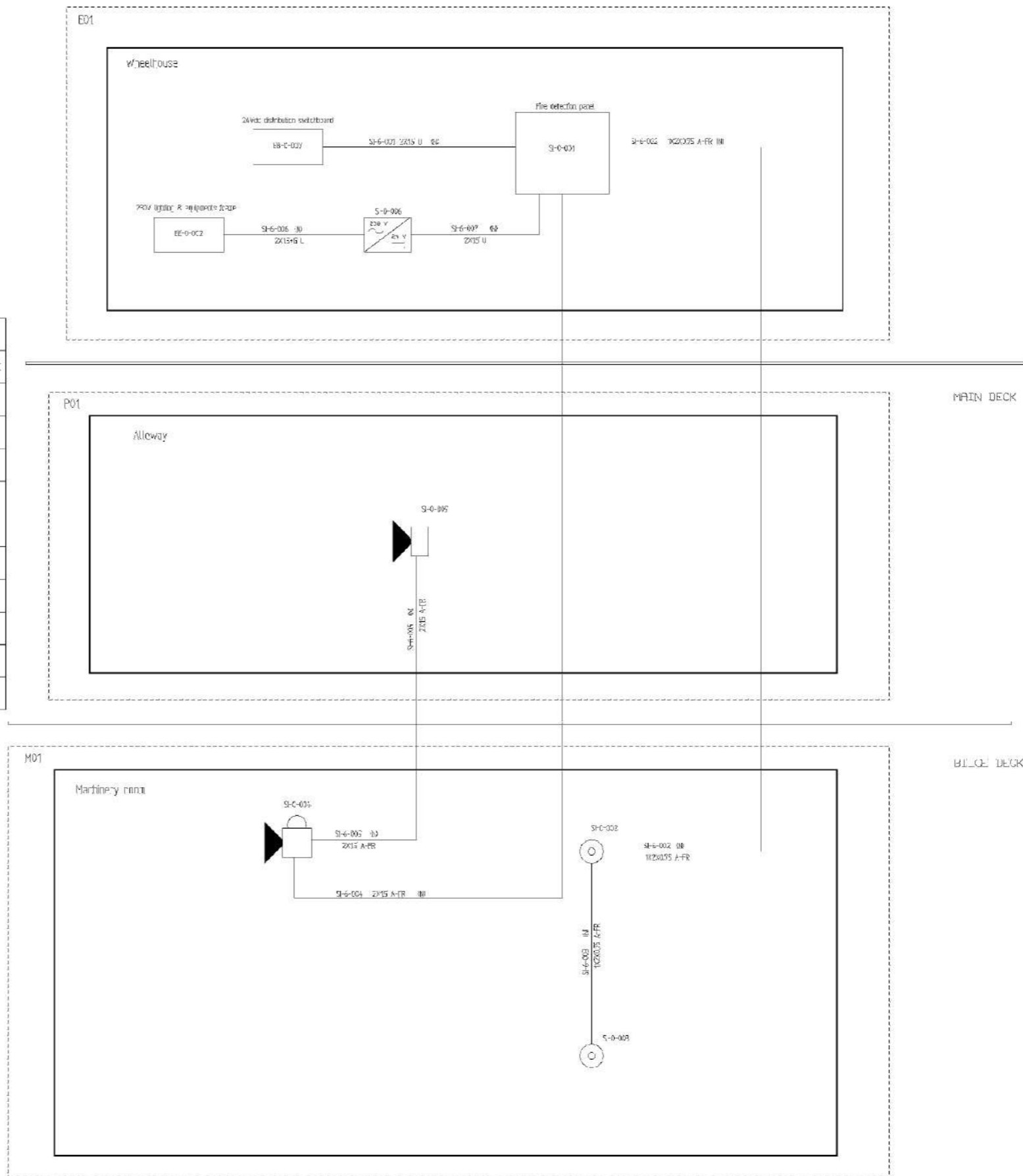

Doc. Title	Ship Information Handbook		208 / 226
Doc. Reference	23,3 m Trawler		
Doc. Revision & Date	A - 15/09/14		

© CMN group all rights reserved

Figure 7-18 Fire Detection System



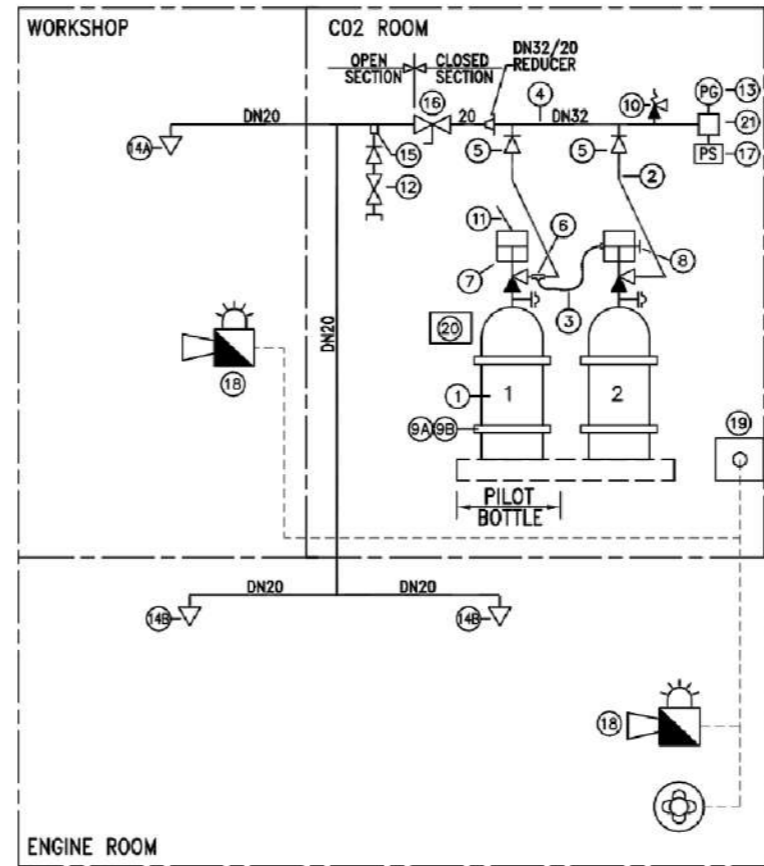
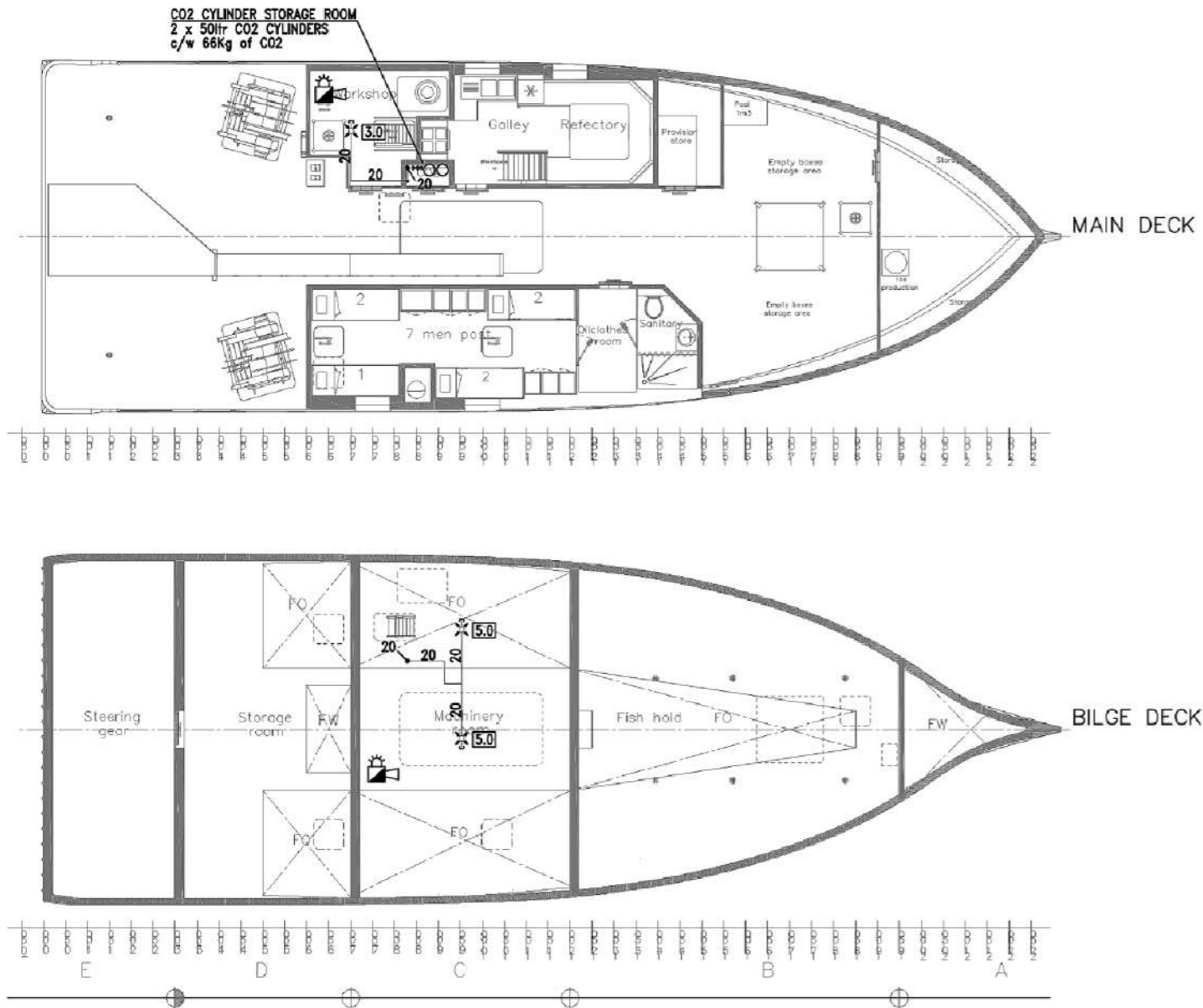

REF	SIZE	QTY	DESCRIPTION	PART No.
1	33KG	2	SOLTR CO2 BOTTLE	-
2	-	2	DISCHARGE HOSE	CO 2012
3	-	1	PILOT HOSE	CO 115
4	DN32	1	2 CYLINDER CO2 MANIFOLD	CO 2018
5	-	2	MANIFOLD CHECK VALVE	CO 2014
6	-	1	CO2 DISCHARGE PILOT CONNECTOR	-
7	-	2	CYLINDER VALVE MANUAL/PNEUMATIC	CO 2011
8	3/8"BSPT	1	PLUG	-
9A	-	1	CO2 2 CYLINDER WALL RACK	CO 2019
9B	-	4	CO2 CYLINDER CYLINDER CLAMP	CO 2019
10	-	1	MANIFOLD RELIEF VALVE (120 BAR)	CO 2022
11	-	1	CO2 MECHANICAL RELEASE LEVER	CO 2011
12	DN20	1	SYSTEM BLOW THRO' CONNECTOR	CO 2024
13	-	1	PRESSURE GAUGE 0-280 BAR	CO 2025
14A	15mm	1	DISCHARGE NOZZLE CODE 3.0	CO 2026
14B	15mm	2	DISCHARGE NOZZLE CODE 5.0	CO 2026
15	-	1	SINGLE CYLINDER ADAPTOR	SL94010
16	DN20	1	CO2 SYSTEM ISOLATION VALVE	-
17	-	1	CO2 SYSTEM PRESSURE SWITCH	CO 2021
18	-	2	AUDIBLE/VISUAL ALARM	20-118
19	-	1	CO2 ROOM DOOR MICROSWITCH	-
20	-	1	WARNING/INSTRUCTION LABEL	CO 2052
21	-	1	2-PORT END CAP	SL93951

**IN THE EVENT OF FIRE:-**  
**SEQUENCE OF OPERATION :-**

1. OPEN CO2 ROOM DOOR. ALARMS WILL BE ACTIVATED IN THE SPACE AND VENTILATION SHUTDOWN ENABLED.
2. ENSURE ALL PERSONNEL ARE CLEAR OF AFFECTED AREA.
3. OPEN CO2 ISOLATION VALVE REF 16.
4. PROCEED TO PILOT CO2 CYLINDER 1. REMOVE PIN AND PULL LEVER SHARPLY ON TOP OF CYLINDER.

**CO2 DISCHARGED**

DO NOT RE-ENTER AREA UNTIL SAFETY OFFICER HAS CERTIFIED AREA SAFE

**TESTING**  
**FUNCTION TESTS**  
 1. OPERATION OF ALARM INDICATION  
 2. RELIEF VALVE SETTING (FACTORY TEST CERT)  
 3. OPERATION OF VENTILATION SHUT DOWN

**HYDROSTATIC PRESSURE TESTS**  
 CLOSED SECTION PIPEWORK - 128 BAR  
 OPEN ENDED PIPEWORK - 7 BAR

Doc. Title	Ship Information Handbook		209 / 226
Doc. Reference	23,3 m Trawler		
Doc. Revision & Date	A - 15/09/14		

© CMN group all rights reserved

Figure 7-19 CO2 Fire Extinguishing System

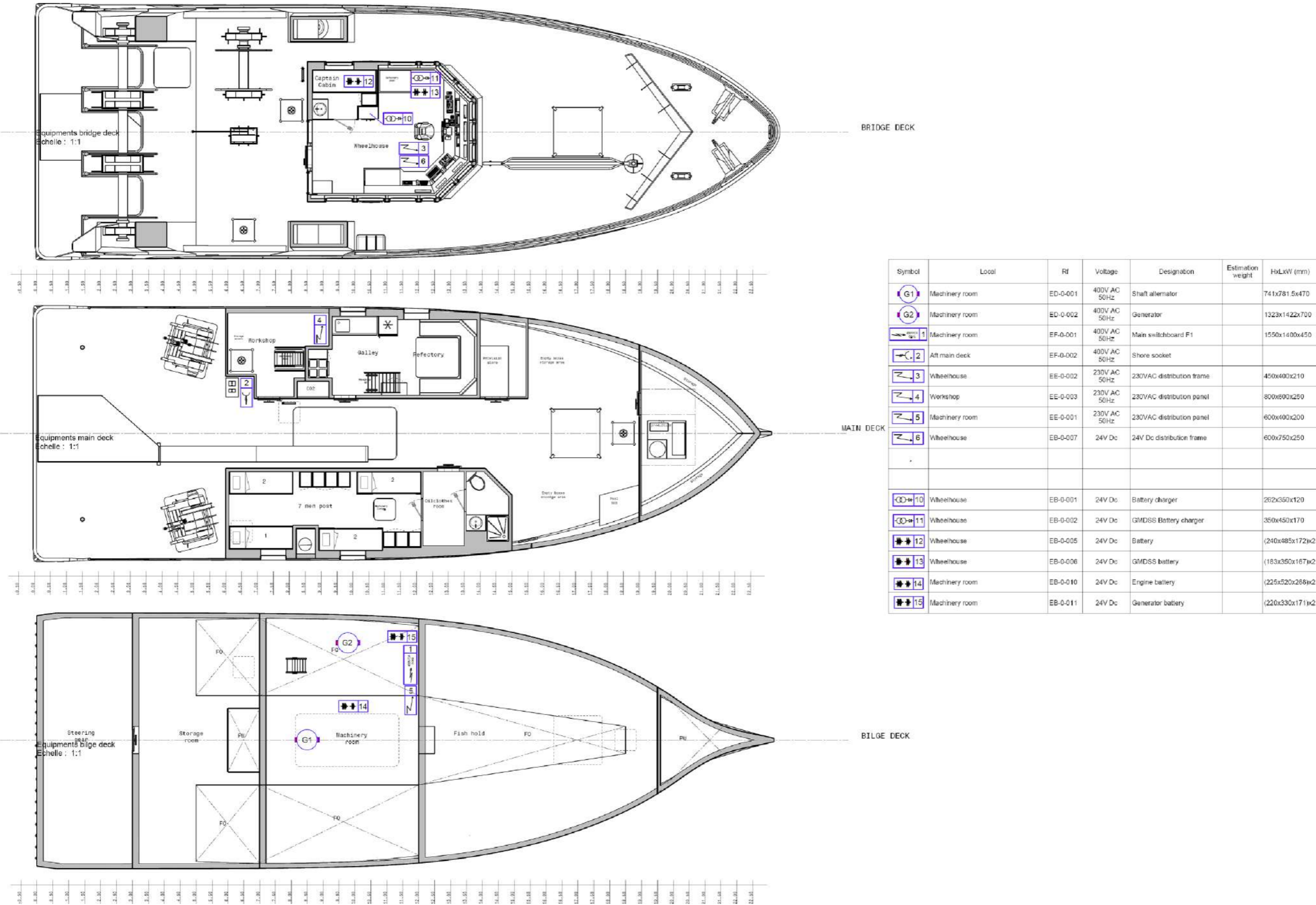

Doc. Title	Ship Information Handbook		210 / 226
Doc. Reference	23,3 m Trawler		
Doc. Revision & Date	A - 15/09/14		

© CMN group all rights reserved

Figure 7-20 Electric Equipment Location

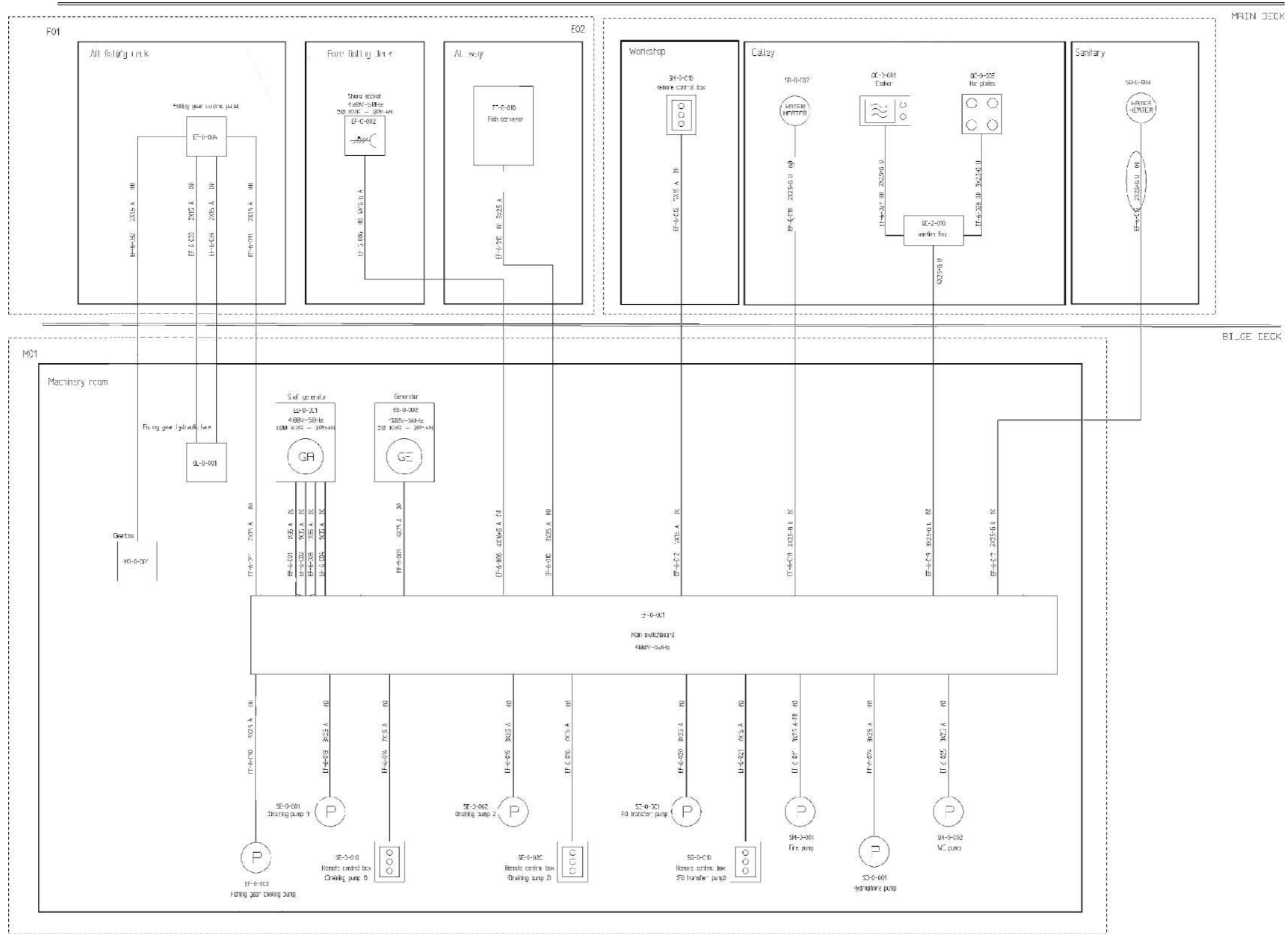

Doc. Title	Ship Information Handbook		211 / 226
Doc. Reference	23,3 m Trawler		
Doc. Revision & Date	A - 15/09/14		

© CMN group all rights reserved

Figure 7-21 AC 400V 50Hz Network

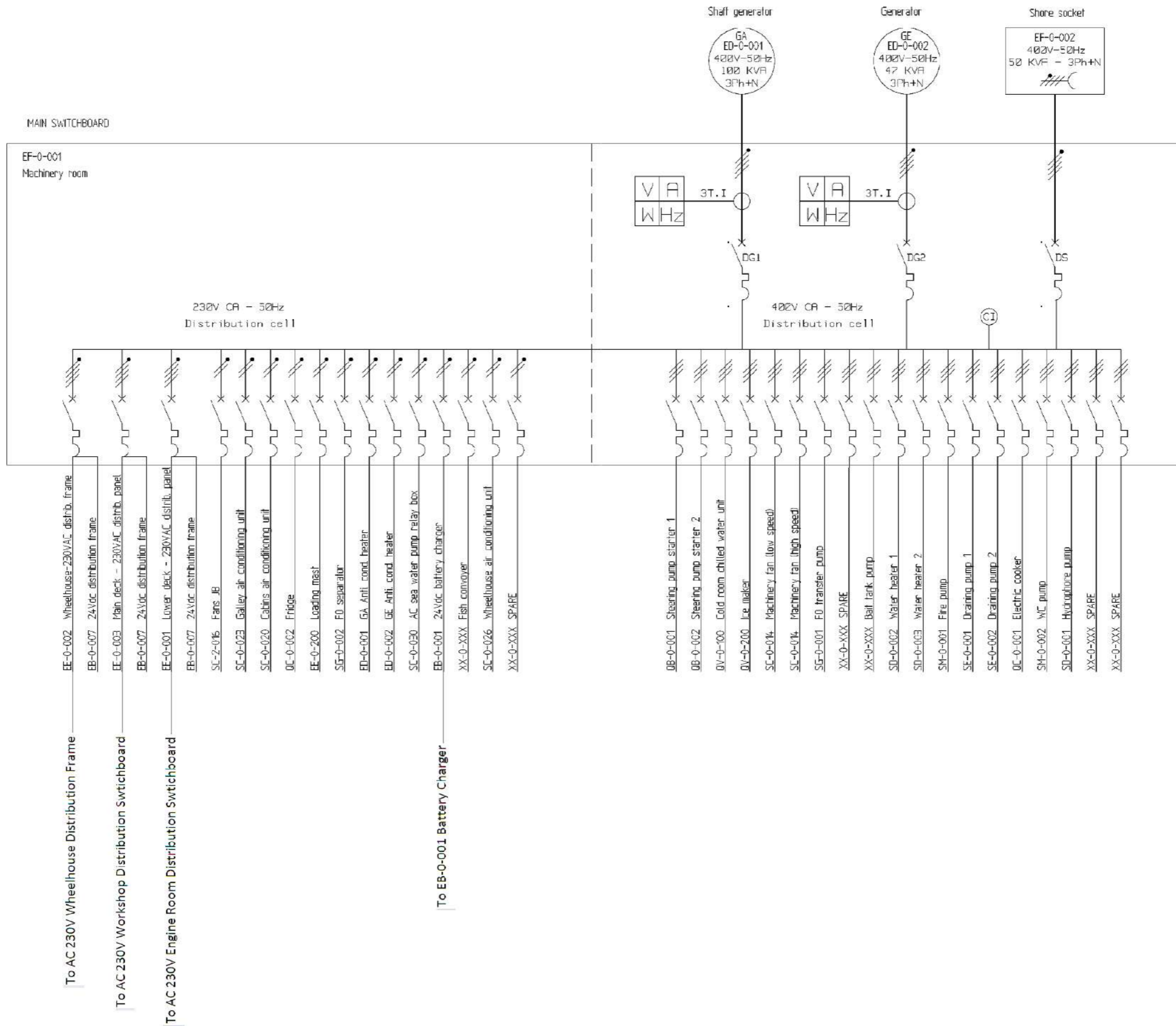



Doc. Title	Ship Information Handbook			212 / 226
Doc. Reference	23,3 m Trawler			
Doc. Revision & Date	A - 15/09/14			

Figure 7-22 Main Switchboard Diagram

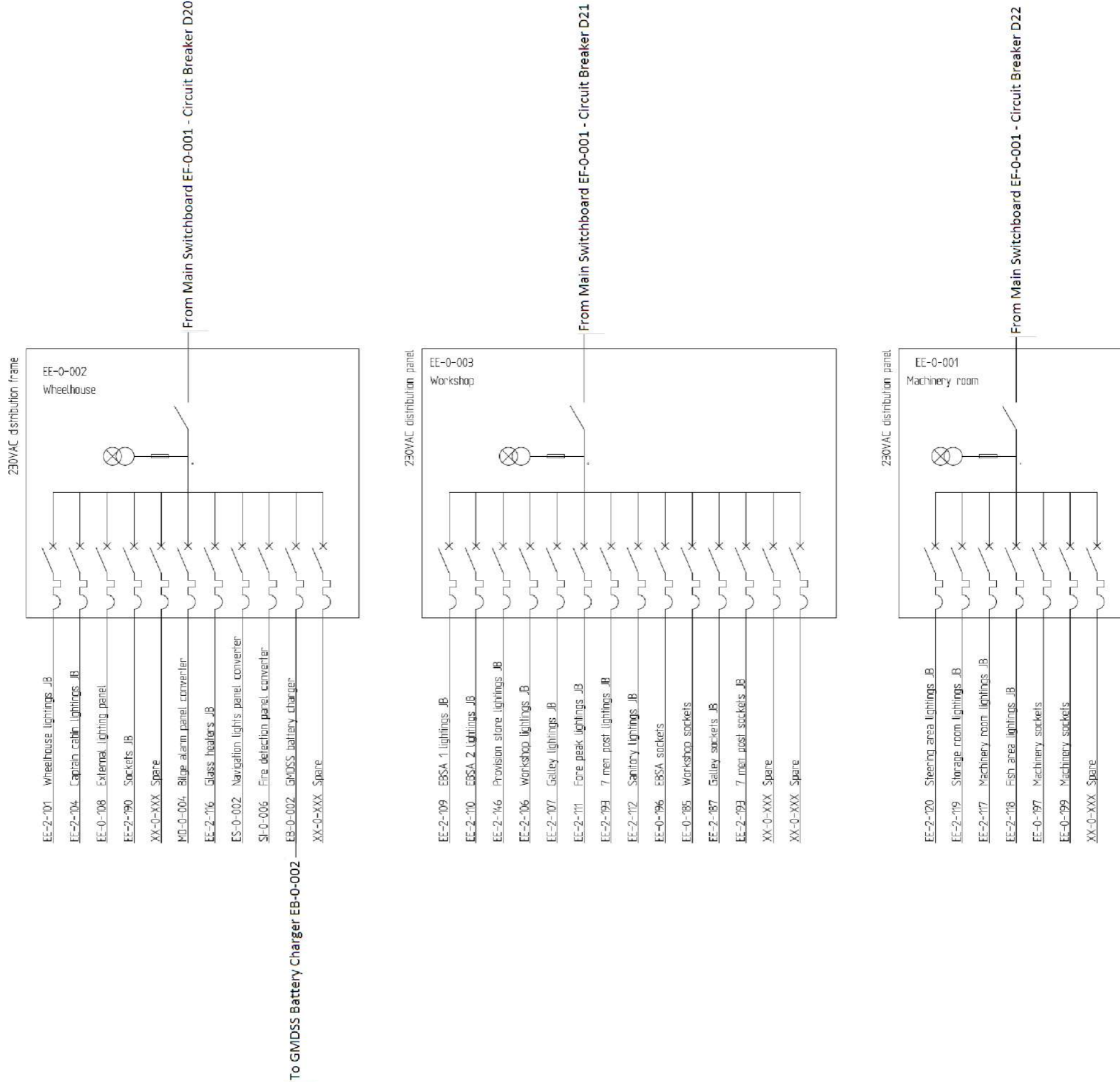

Doc. Title	Ship Information Handbook			213 / 226
Doc. Reference	23,3 m Trawler			
Doc. Revision & Date	A - 15/09/14			

© CMN group all rights reserved



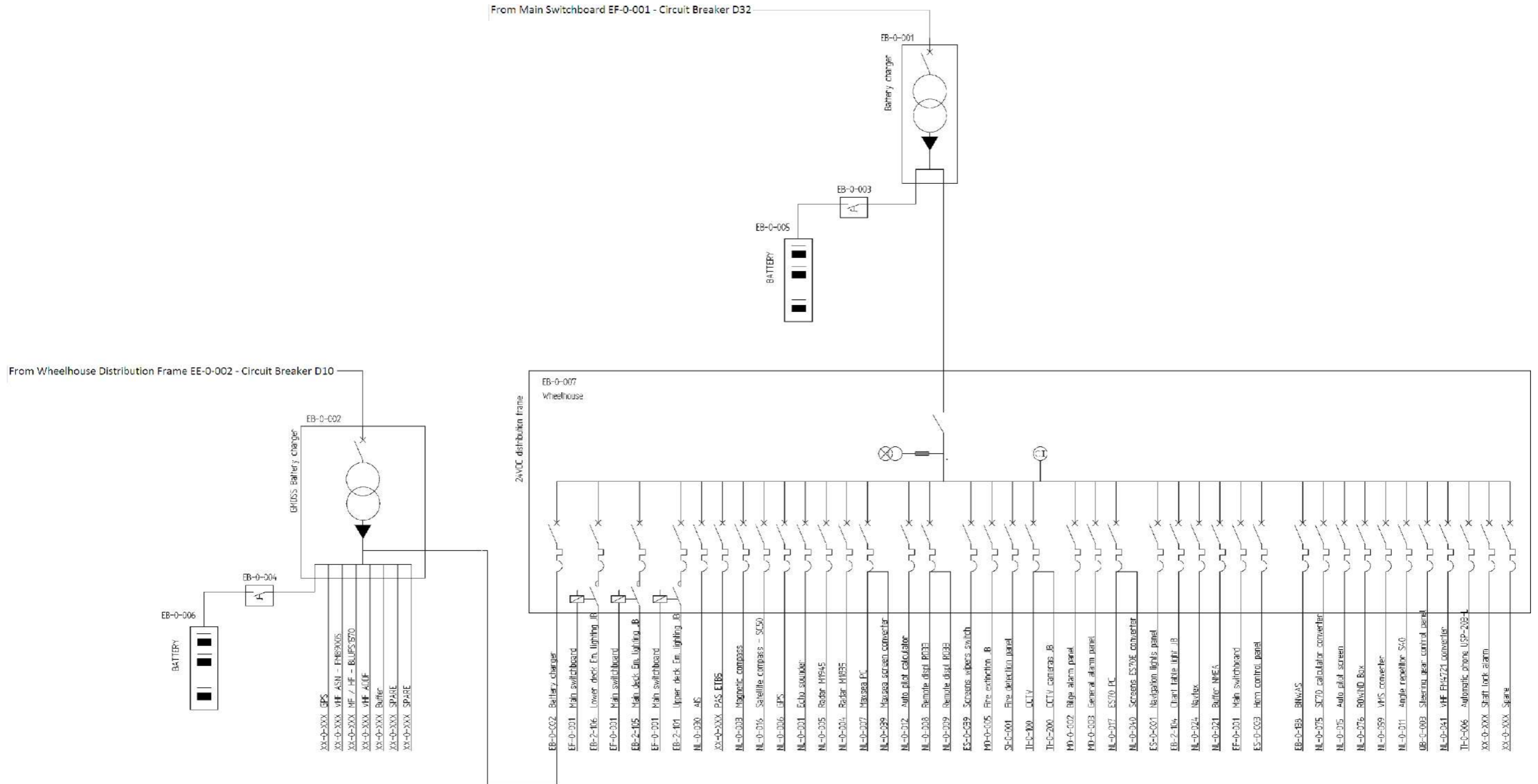





Figure 7-23 AC 230V Secondary Switchboards Diagram





Doc. Title	Ship Information Handbook		214 / 226
Doc. Reference	23,3 m Trawler		
Doc. Revision & Date	A - 15/09/14		

© CMN group all rights reserved

Figure 7-24 DC 24V Distribution Network and Wheelhouse Frame Diagram

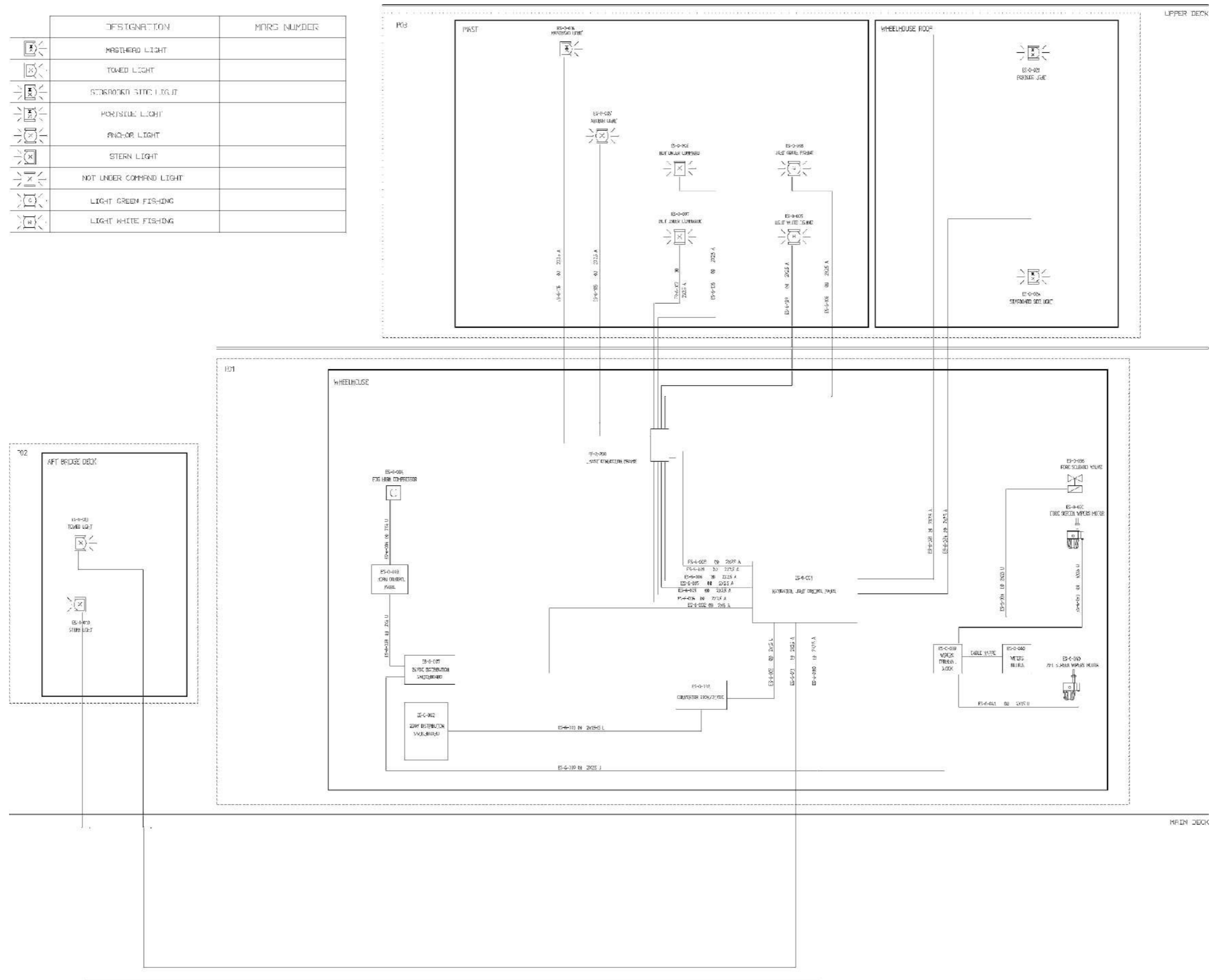
DESIGNATION	MFRS NUMBER
 MASTHEAD LIGHT	
 TOWED LIGHT	
 RED STARBOARD SIDE LIGHT	
 RED PORT SIDE LIGHT	
 ANCHOR LIGHT	
 STERN LIGHT	
 NOT UNDER COMMAND LIGHT	
 LIGHT GREEN FISHING	
 LIGHT WHITE FISHING	



Doc. Title	Ship Information Handbook		215 / 226
Doc. Reference	23,3 m Trawler		
Doc. Revision & Date	A - 15/09/14		

© CMN group all rights reserved

Figure 7-25 DC 24V Navigation Light Network

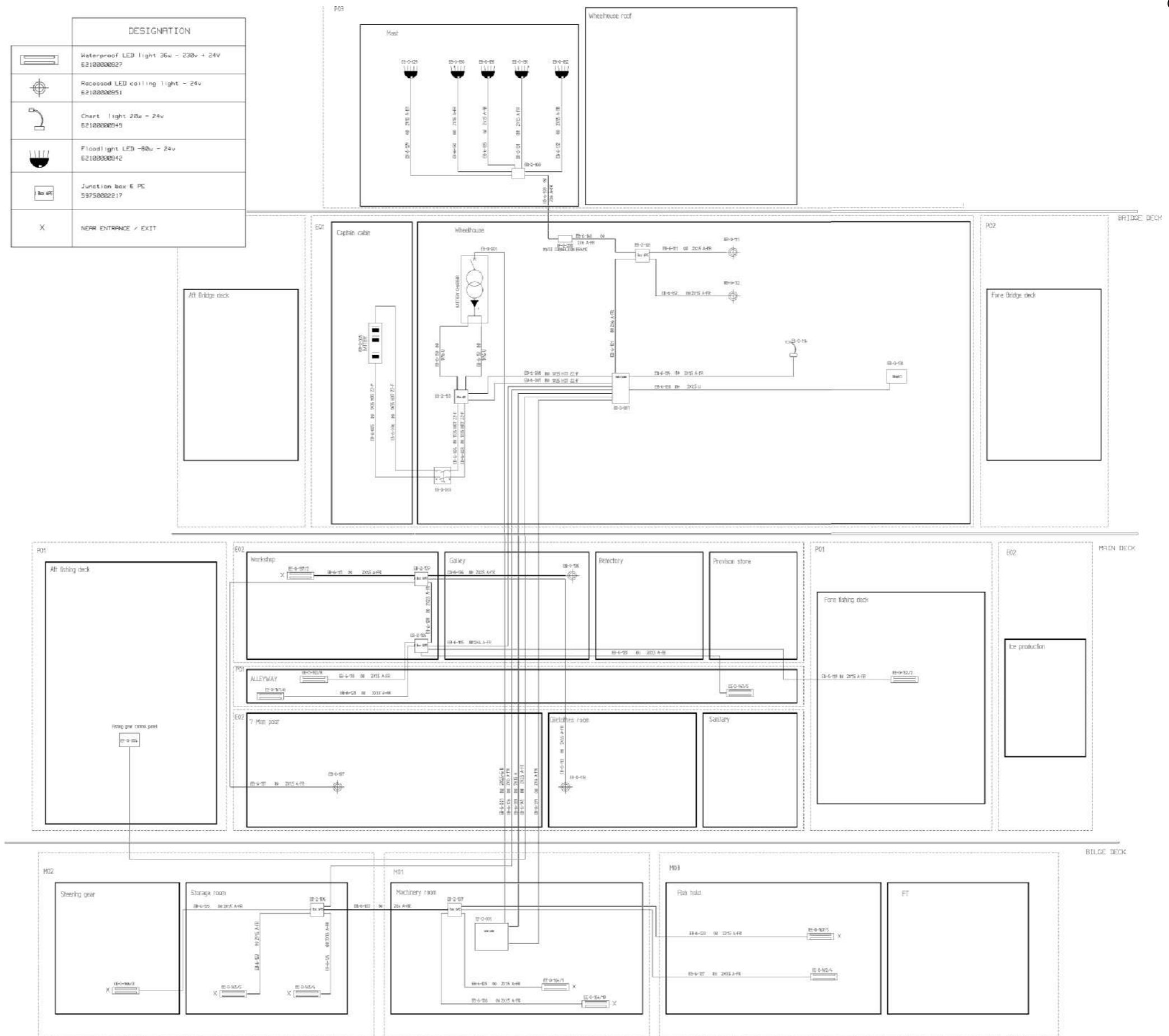

Doc. Title	Ship Information Handbook		216 / 226
Doc. Reference	23,3 m Trawler		
Doc. Revision & Date	A - 15/09/14		

© CMN group all rights reserved

Figure 7-26 DC 24V Network



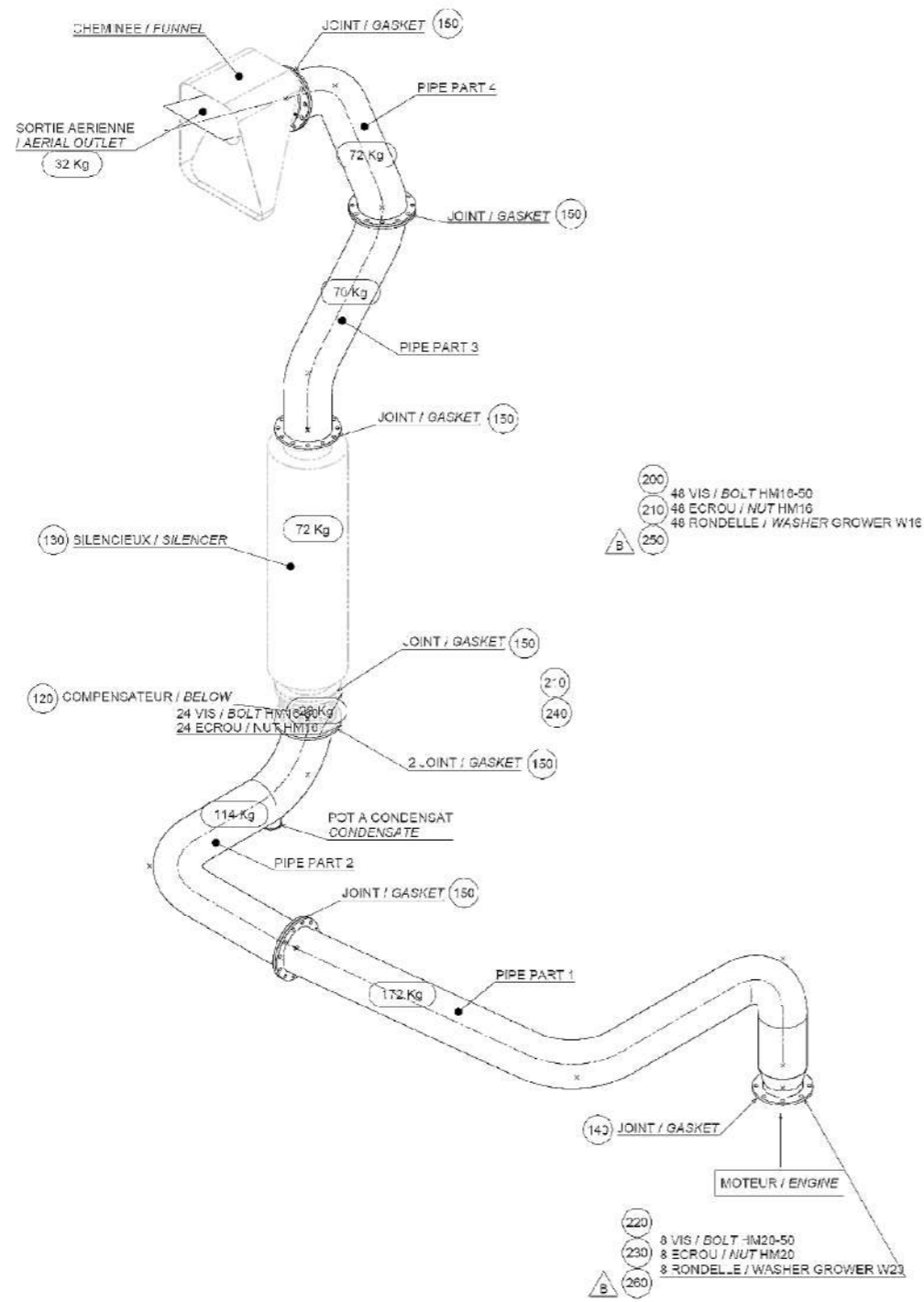

Main Engine Exhaust

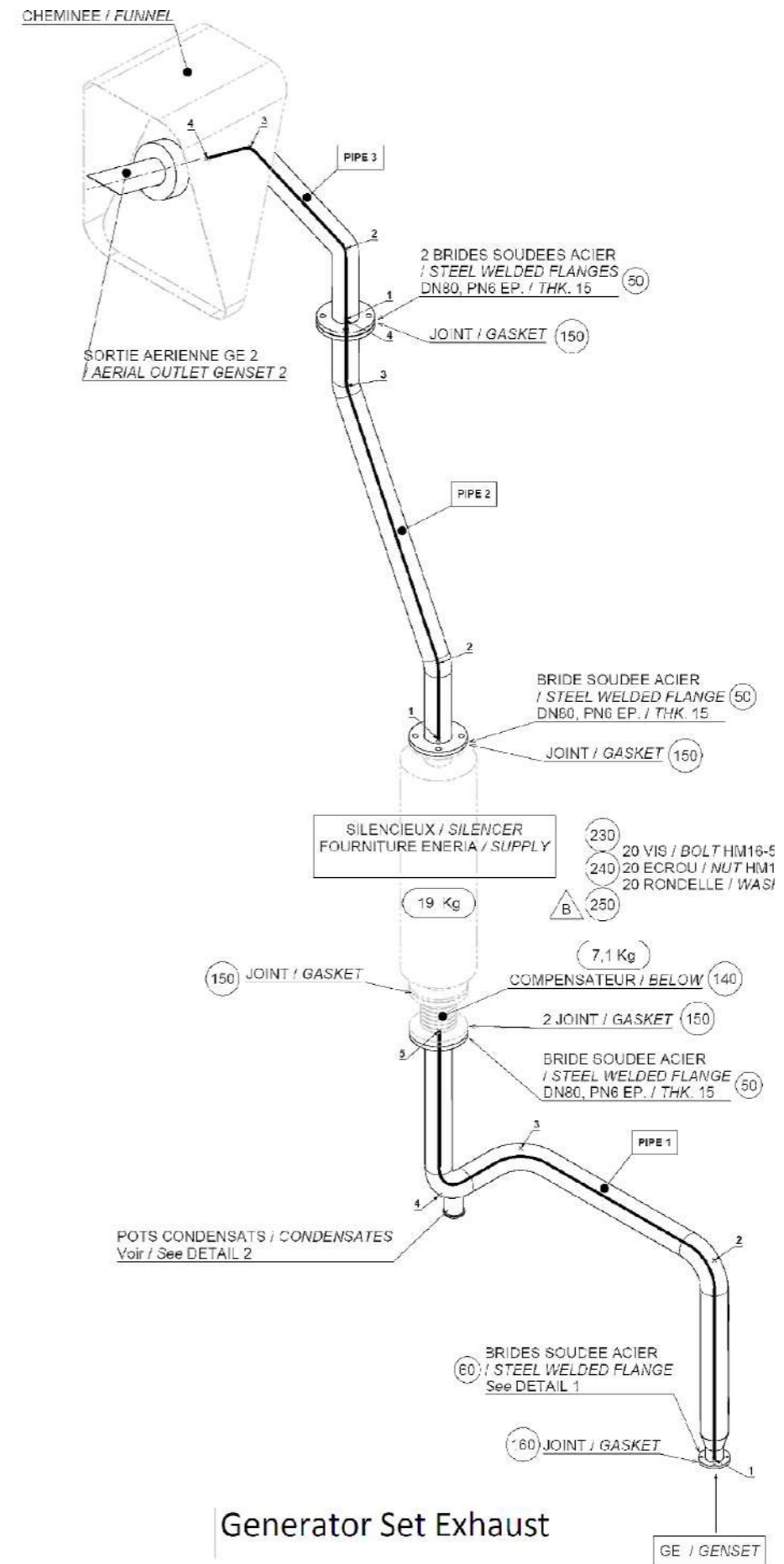



Generator Set Exhaust

Doc. Title	Ship Information Handbook		217 / 226
Doc. Reference	23,3 m Trawler		
Doc. Revision & Date	A - 15/09/14		

© CMN group all rights reserved

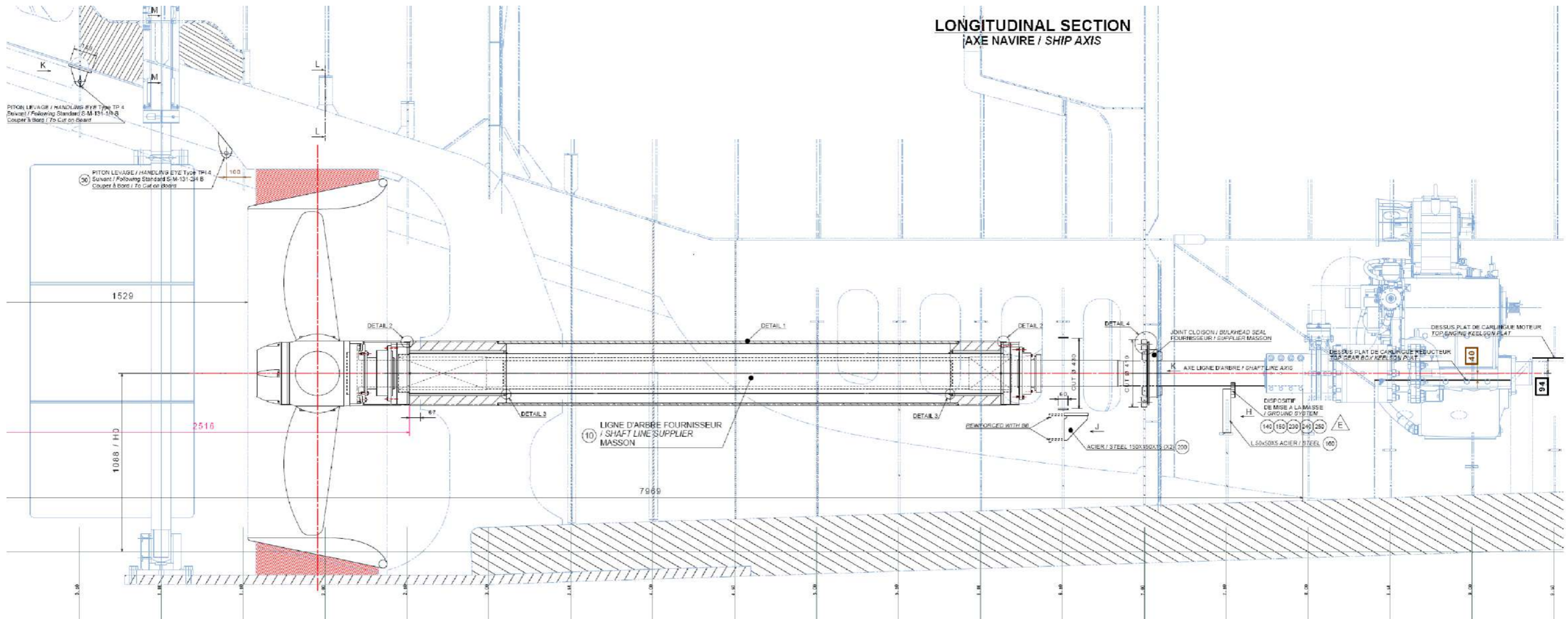
Figure 7-27 Exhaust System



Doc. Title	Ship Information Handbook		218 / 226
Doc. Reference	23,3 m Trawler		
Doc. Revision & Date	A - 15/09/14		

© CMN group all rights reserved

Figure 7-28 Controllable Pitch Propeller and Transmission Plant

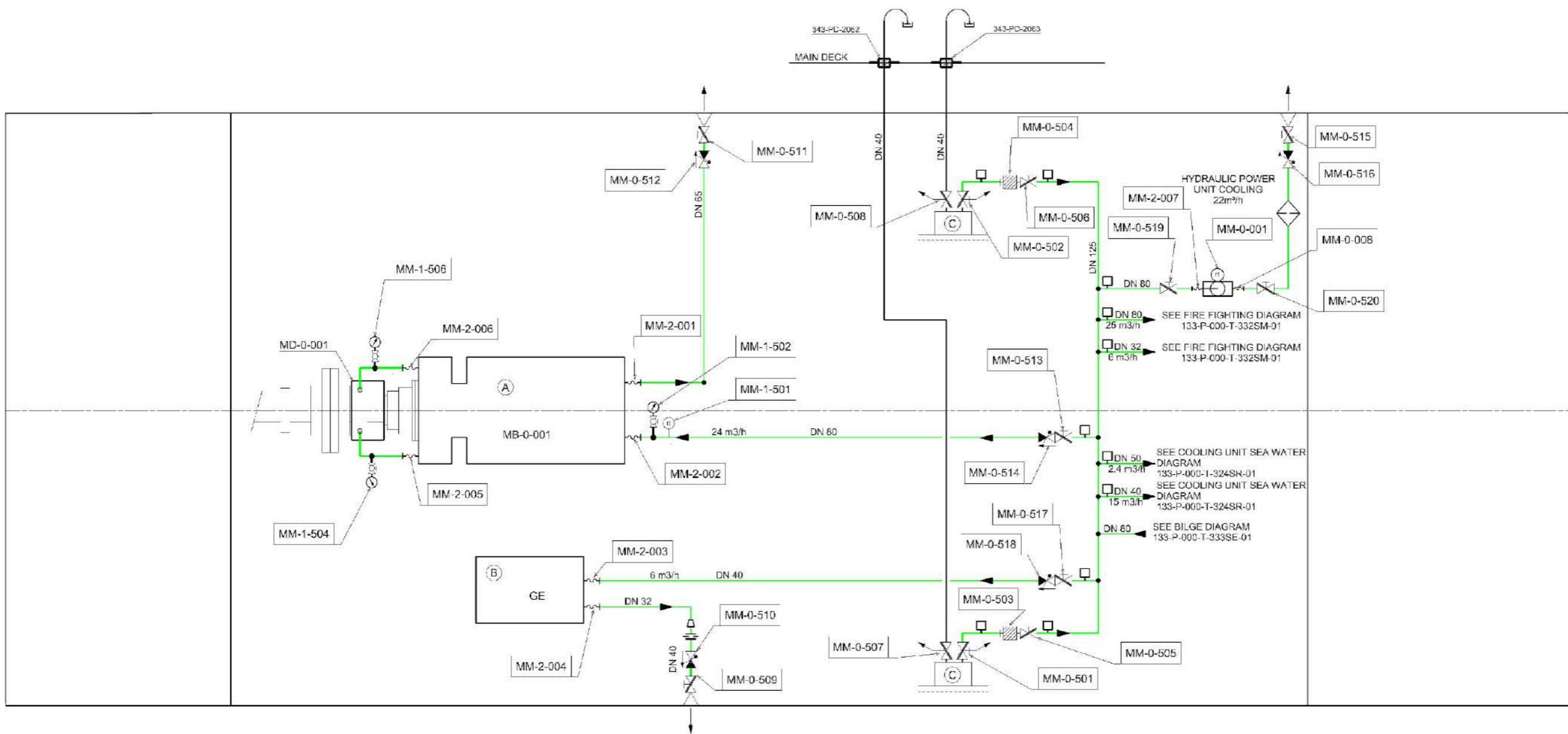

**MAINS APPLIANCES**

- (A) MAIN ENGINE
- (B) GENSET

**APPLIANCES SYMBOLS FOLLOWING CMN STANDARD**

- |  |                                |  |                         |
|--|--------------------------------|--|-------------------------|
|  | ELECTRO-PUMP                   |  | HULL OUT GOING          |
|  | FILTER                         |  | SEA WATER INLET         |
|  | RESTRICTOR                     |  | BOSS FOR PRESSURE GAUGE |
|  | BALL VALVE                     |  | BOSS FOR THERMOMETER    |
|  | SWING CHECK VALVE              |  | ZINC                    |
|  | FLEXIBLE HOSE OR COMPENSATOR   |  | PRESSURE GAUGE          |
|  | REMOTE CONTROL BUTTERFLY VALVE |  | TEMPERATURE INDICATOR   |
|  | BUTTERFLY VALVE                |  | UNIT COOLING            |
|  | ANGLE GLOBE VALVE              |  |                         |

Doc. Title	Ship Information Handbook		219 / 226
Doc. Reference	23,3 m Trawler		
Doc. Revision & Date	A - 15/09/14		

© CMN group all rights reserved

Figure 7-29 Engine Cooling System

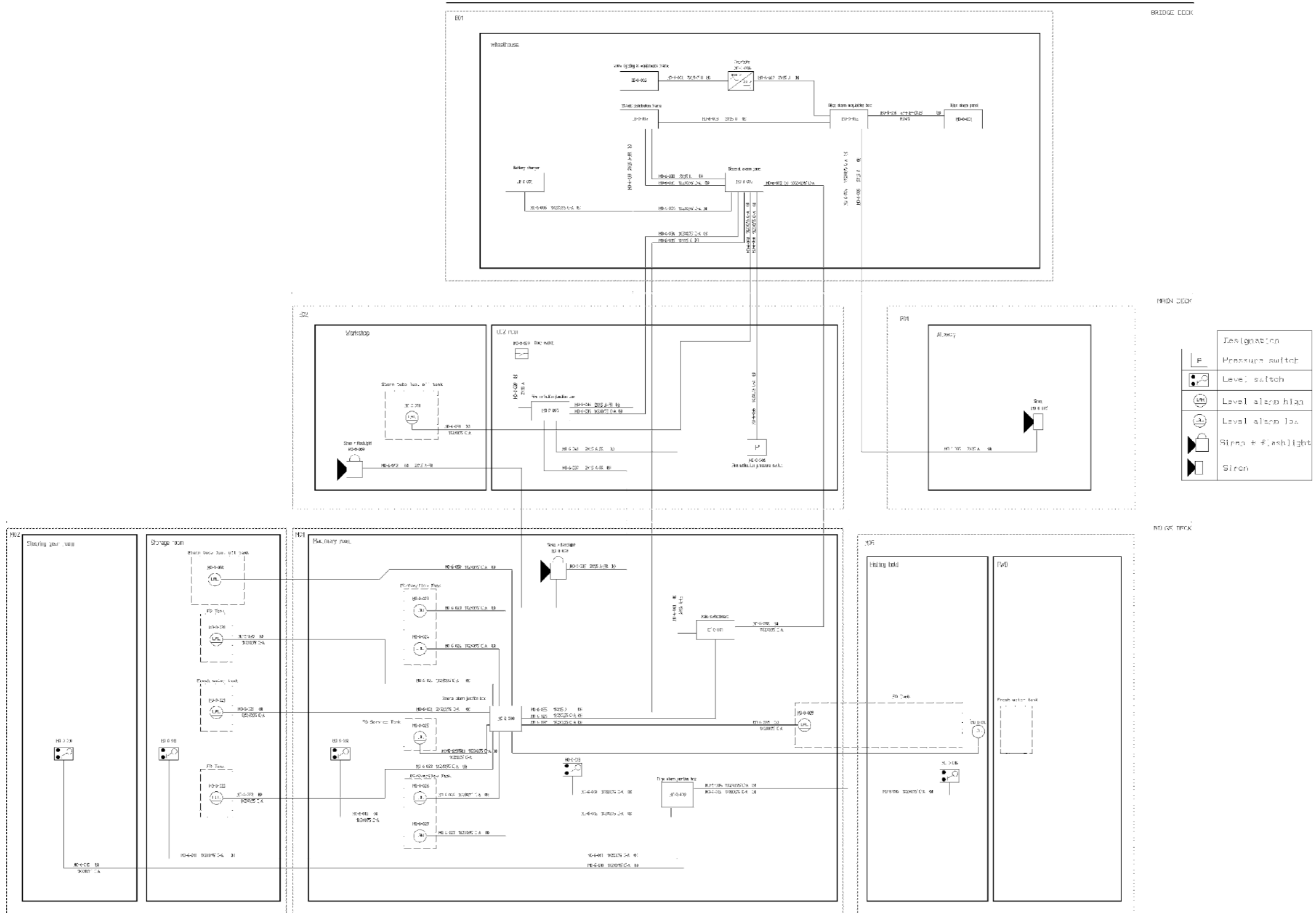

Doc. Title	Ship Information Handbook		220 / 226
Doc. Reference	23,3 m Trawler		
Doc. Revision & Date	A - 15/09/14		

© CMN group all rights reserved

Figure7-30 Alarm and Safety Network



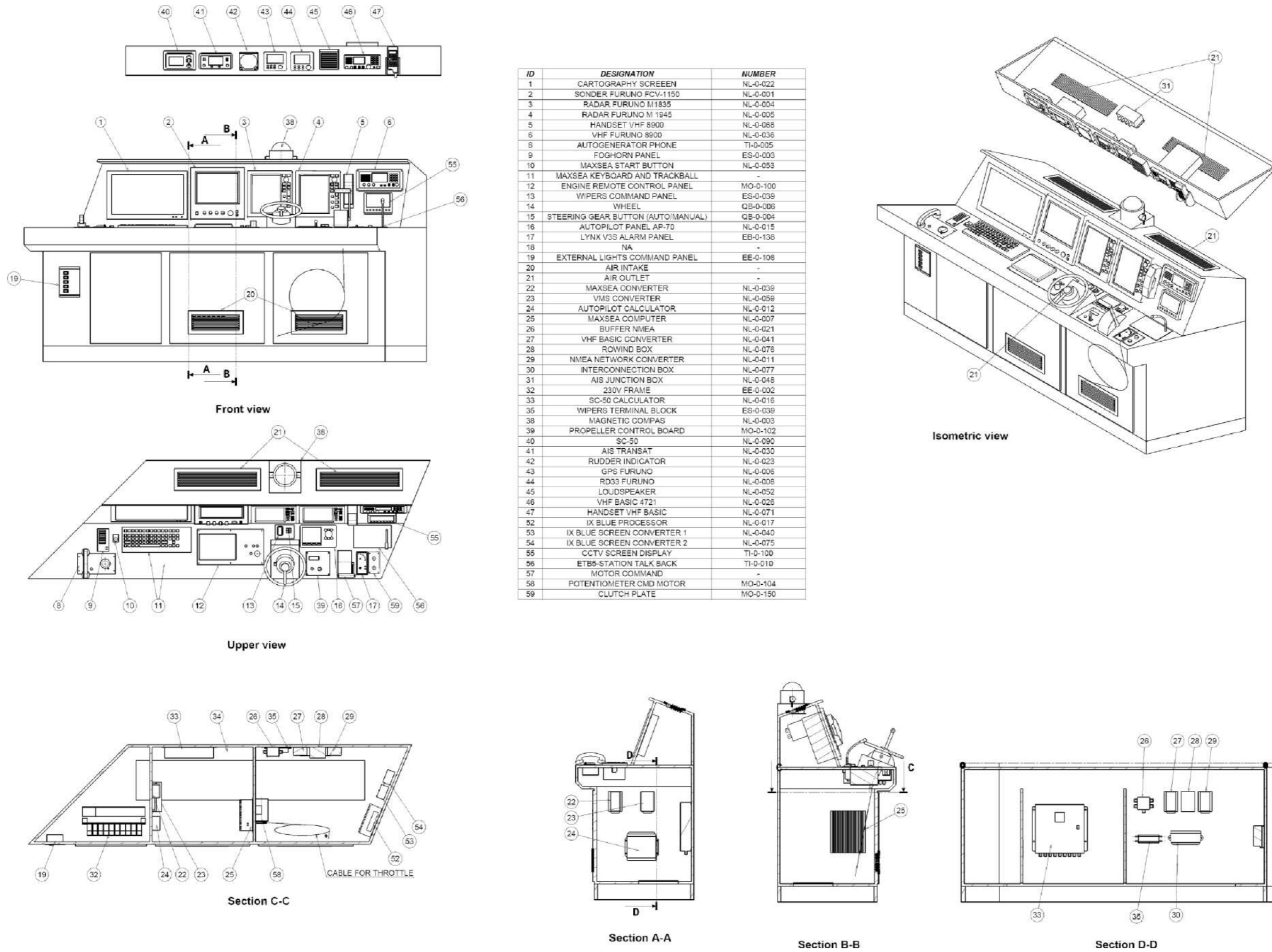

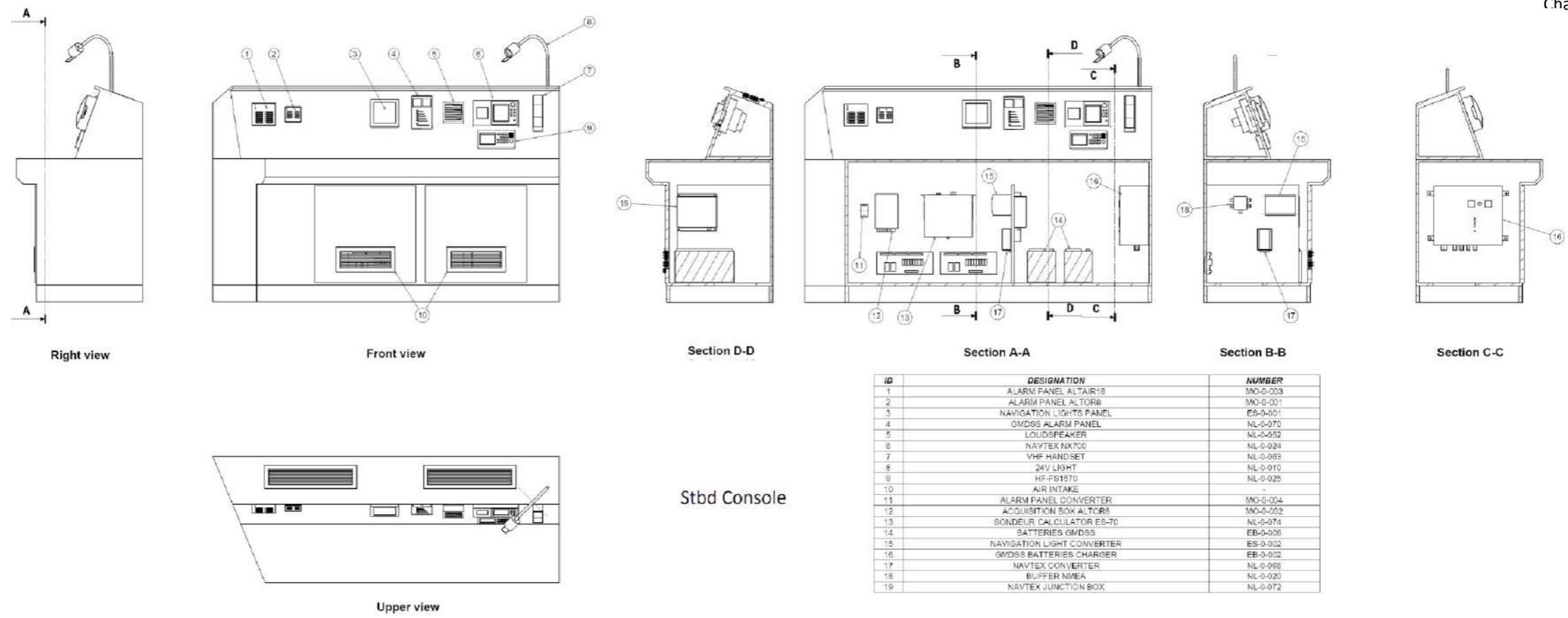
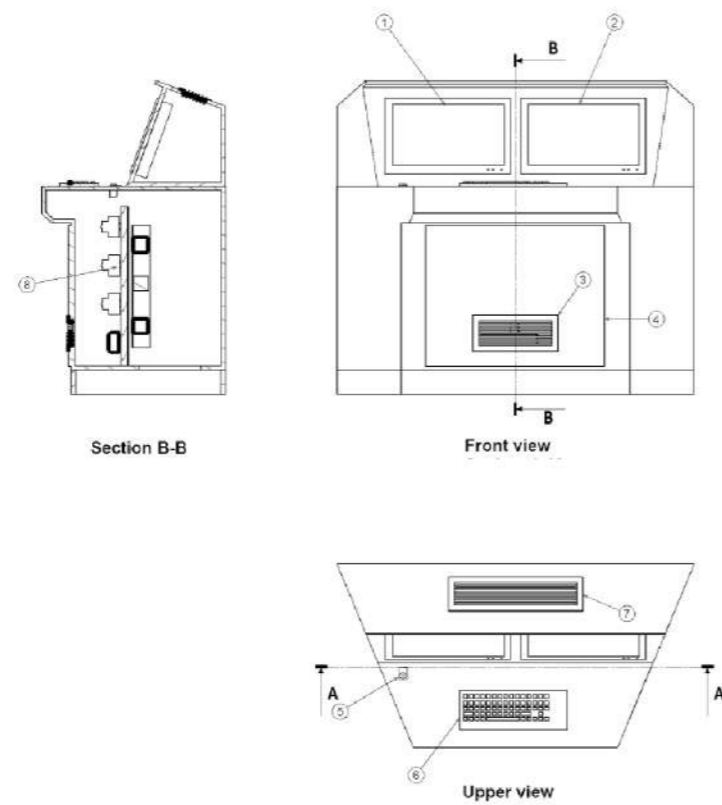

Figure 7-32 Wheelhouse Fwd Console

Doc. Title	Ship Information Handbook		222 / 226
Doc. Reference	23,3 m Trawler		
Doc. Revision & Date	A - 15/09/14		



Stbd Console



ID	DESIGNATION	NUMBER
1	XBBLUE SCREEN 1	NL-0-019
2	XBBLUE SCREEN 2	NL-0-068
3	AIR INTAKE	-
4	DOOR	-
5	START XBBLUE	-
6	KEYBOARD AND TRACKBALL	-
7	AIR OUTLET	-
8	24V FRAME	EE-0-007

Corner Console

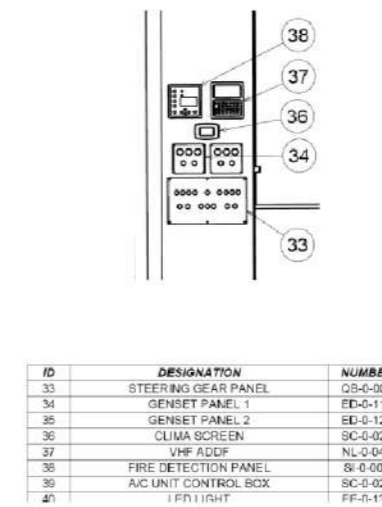

Aft Console



Doc. Title	Ship Information Handbook		223 / 226
Doc. Reference	23,3 m Trawler		
Doc. Revision & Date	A - 15/09/14		

Figure 7-33 Wheelhouse Stbd, Corner and Aft Consoles



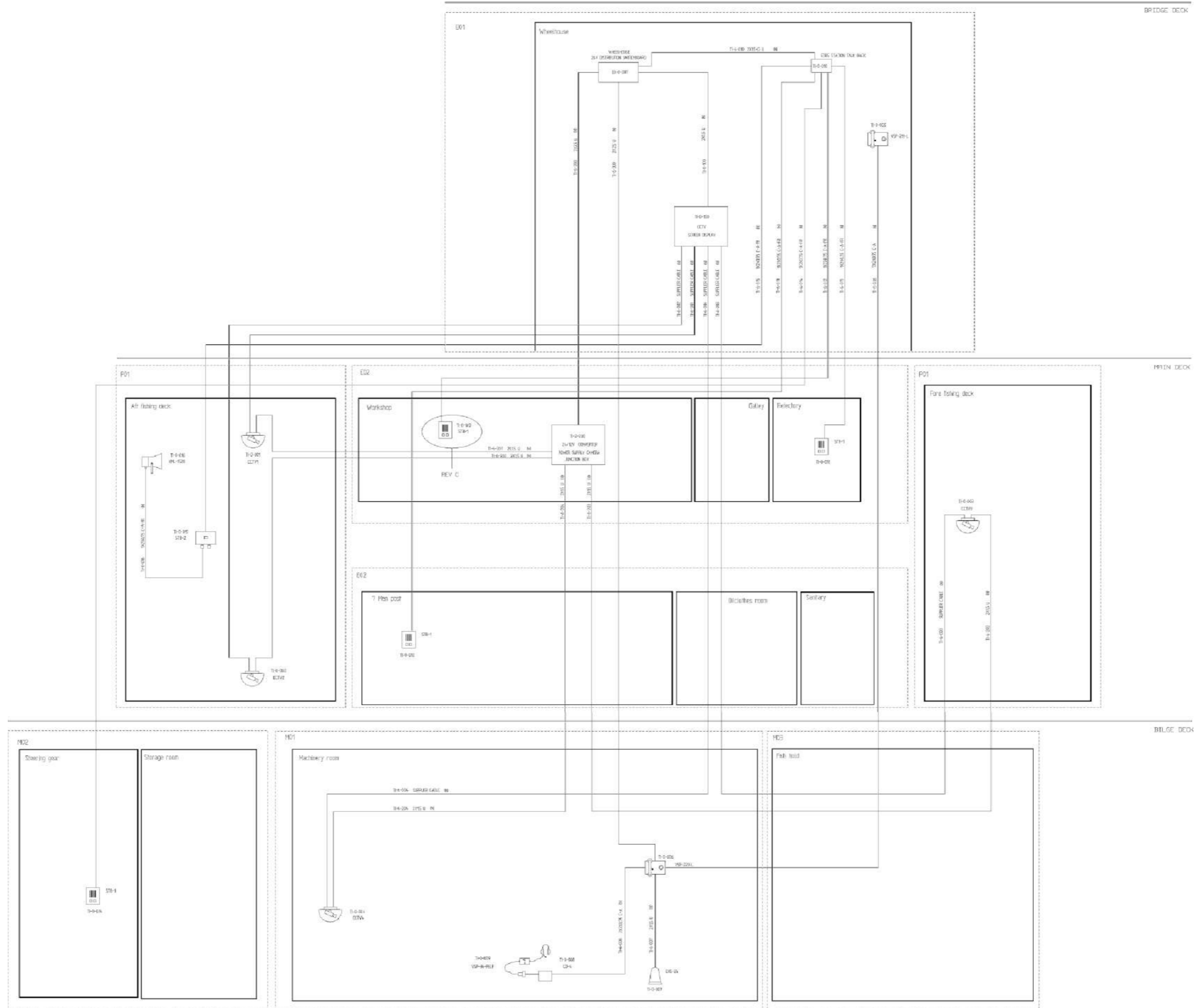

Doc. Title	Ship Information Handbook		224 / 226
Doc. Reference	23,3 m Trawler		
Doc. Revision & Date	A - 15/09/14		

© CMN group all rights reserved

Figure 7-34 Internal Communications System

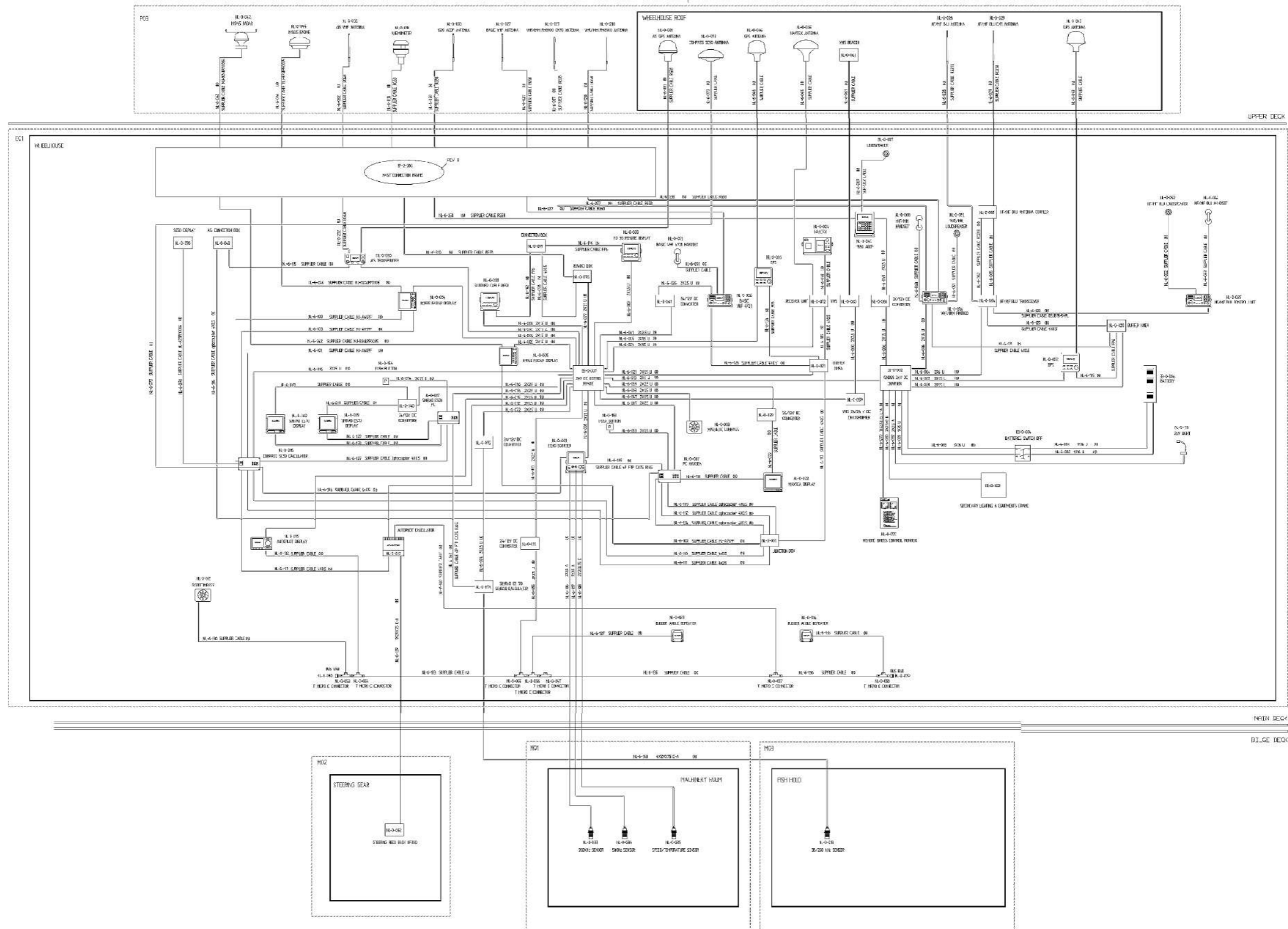



Doc. Title	Ship Information Handbook		225 / 226
Doc. Reference	23,3 m Trawler		
Doc. Revision & Date	A - 15/09/14		

© CMN group all rights reserved

Figure 7-35 External Communications System

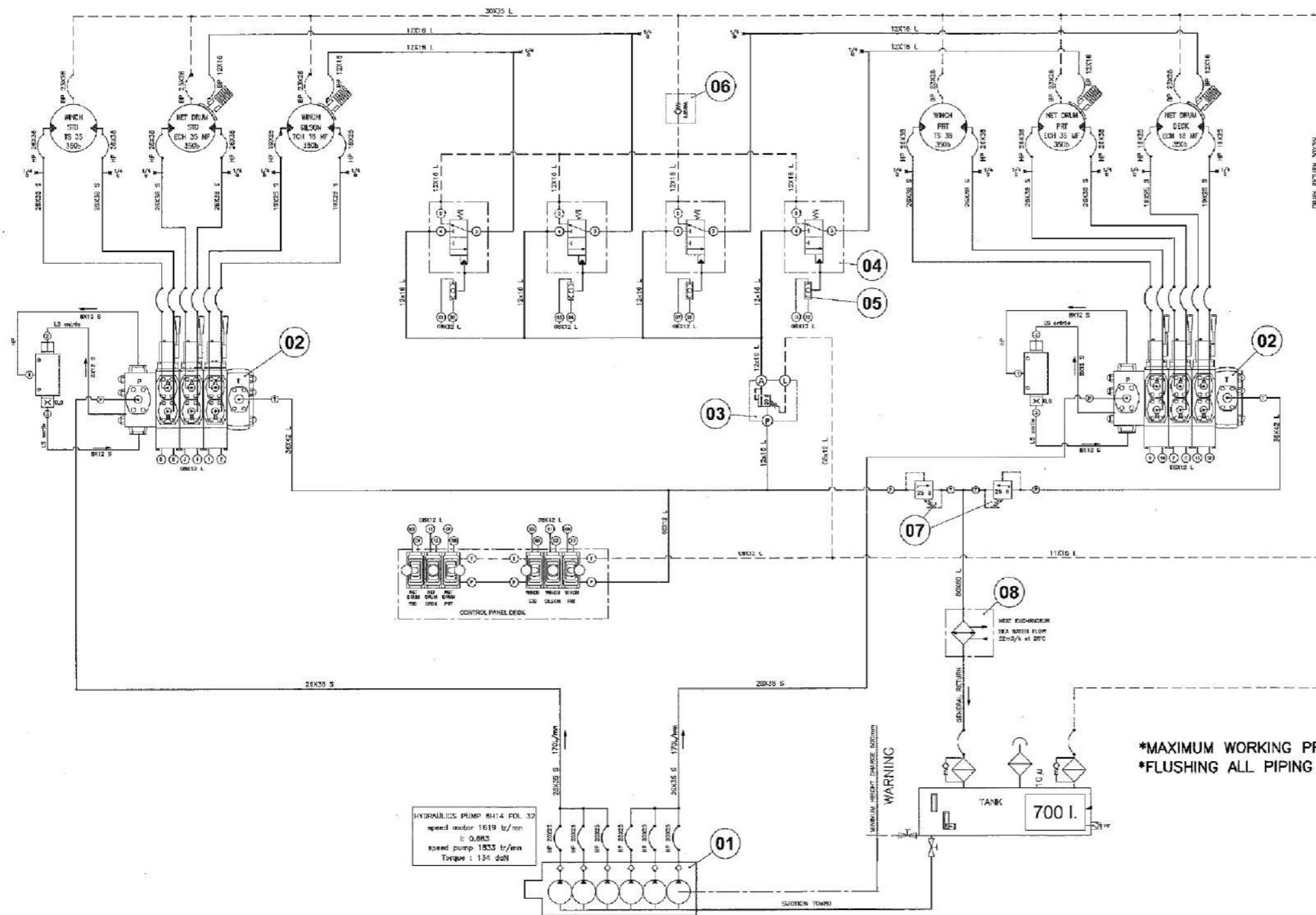

Main Equipment

- 01 Hydraulic Pump driven by Gearbox
- 02 Hydraulic Distributor
- 03 Pressure Reducer
- 04 Brake Control Selector
- 05 Non Return Valve
- 06 Non Return Valve 0,35Bar
- 07 Relief Valve
- 08 Oil Cooler

\*Matériau:  
 TU52b Rm=510 N/mm for pressure pipes  
 TU37b Rm=380 N/mm for other

\*MAXIMUM WORKING PRESSURE 350 Bar  
 \*FLUSHING ALL PIPING BEFORE TESTING : Required class 7 as pep norm NAS1638

Doc. Title	Ship Information Handbook		226 / 226
Doc. Reference	23,3 m Trawler		
Doc. Revision & Date	A - 15/09/14		

Figure 7-36 Fishing Gear System